

Prices Effective
July 1, 2019

STREETX

Metrum

Price List

Product Information Applications:

Lounge

Dimensions / Overview **General Information**

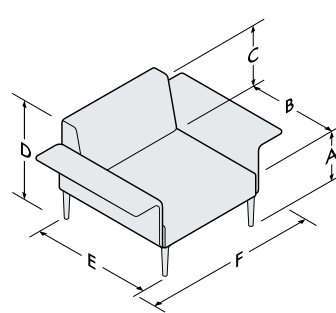
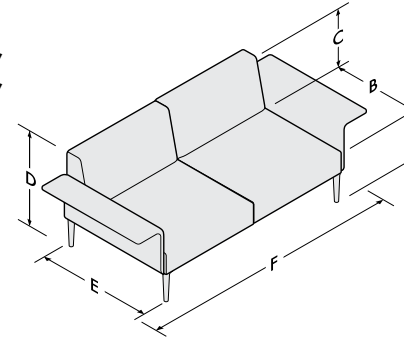
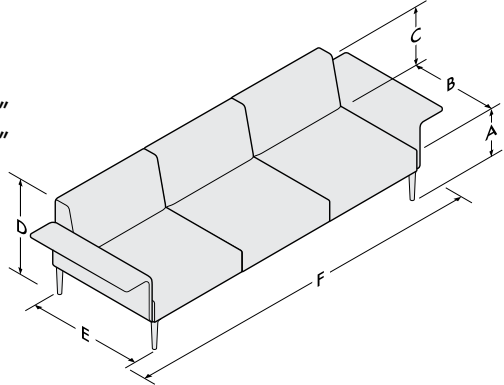
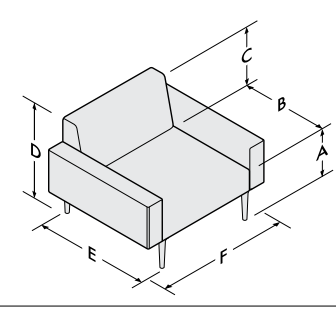
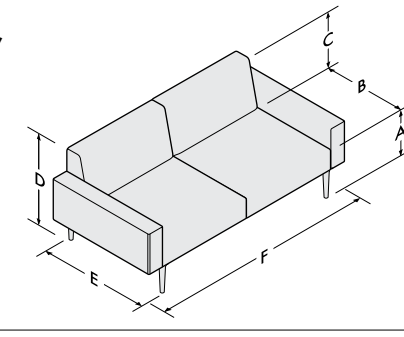
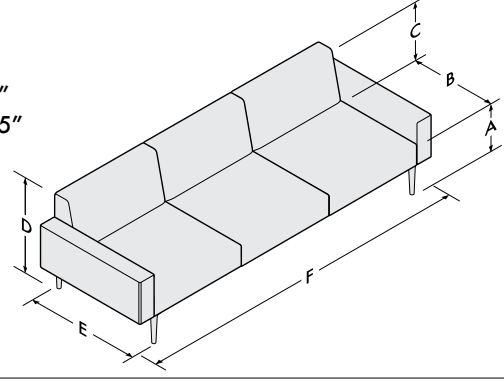
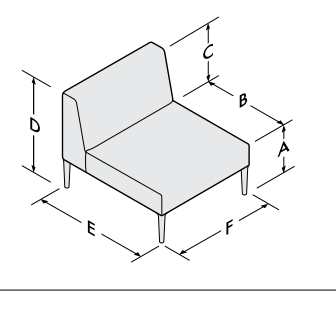
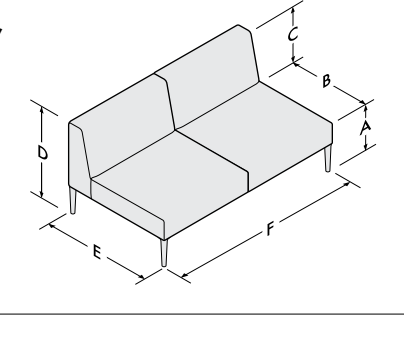
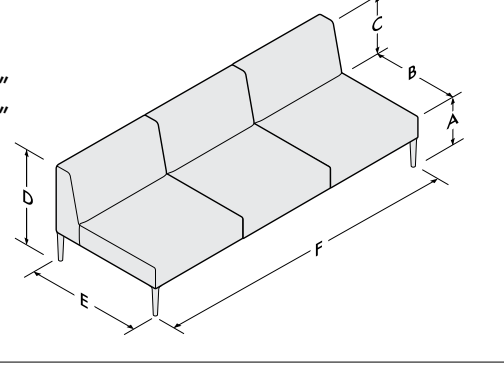
<p>Low-Back with Cantilever Arms</p> <p>A. Seat Height B. Seat Depth C. Back Height D. Overall Height E. Overall Depth F. Overall Width</p>	<p>Single</p> <p>A. 16" B. 23.5" C. 12" D. 28" E. 33.75" F. 48"</p> 	<p>Double</p> <p>A. 16" B. 23.5" C. 12" D. 28" E. 33.75" F. 77.75"</p> 	<p>Triple</p> <p>A. 16" B. 23.5" C. 12" D. 28" E. 33.75" F. 107.5"</p> 	<p>Design Stylex</p> <p>Construction Multi-density, open-cell polyurethane foam is adhered to CARB-Certified internal plywood frame. All seat and back foam surfaces are overlaid with Dacron for enhanced feel and comfort. Dymetrol® webbing is used at the foundation of all seating surfaces to provide additional, flexible support.</p> <p>Legs Metrum is available with cast aluminum or wood legs. Cast aluminum legs may be powder coated in a variety of finishes, or ordered as polished cast aluminum. Wood legs are available in maple, white oak, and walnut. Adjustable glides are standard.</p> <p>Tables A selection of in-stock Caesarstone, solid surface, and wood tables is available.</p> <p>Arms Metrum offers two categories of arms – end arms that can only be added to the outside ends of a unit, and mid-arms that can be added between units in a continuous layout.</p> <p>Configuration While Metrum offers traditional stand-alone units (single seat, double seat, and triple seat), it is at the same time fundamentally flexible. The modular armless seats, corners, arms, and tables have all been designed to encourage creation of a wide variety of set-ups. Units next to each other in a continuous layout share a mid-leg that supports both units. To ensure clarity when ordering modular set-ups, it is critical that line items should be listed in the order in which they will be connected from left end (seated perspective) to right end.</p> <p>Power Optional power receptacles are available for surface mount in tables or undermount on the front of seat units by either the left or right leg. Power units contain 2 USB ports and a standard, grounded 3-prong electrical outlet.</p> <p>Testing Manufactured to comply with ANSI/BIF-MA X5.4 Lounge Seating Tests.</p> <p>Environment Greenguard certified.</p>
<p>Low-Back with Standard Arms</p> <p>A. Seat Height B. Seat Depth C. Back Height D. Overall Height E. Overall Depth F. Overall Width</p>	<p>Single</p> <p>A. 16" B. 23.5" C. 12" D. 28" E. 33.75" F. 41.25"</p> 	<p>Double</p> <p>A. 16" B. 23.5" C. 12" D. 28" E. 33.75" F. 71"</p> 	<p>Triple</p> <p>A. 16" B. 23.5" C. 12" D. 28" E. 33.75" F. 100.75"</p> 	
<p>Low-Back Armless</p> <p>A. Seat Height B. Seat Depth C. Back Height D. Overall Height E. Overall Depth F. Overall Width</p>	<p>Single</p> <p>A. 16" B. 23.5" C. 12" D. 28" E. 33.75" F. 29.75"</p> 	<p>Double</p> <p>A. 16" B. 23.5" C. 12" D. 28" E. 33.75" F. 59.5"</p> 	<p>Triple</p> <p>A. 16" B. 23.5" C. 12" D. 28" E. 33.75" F. 89.25"</p> 	

Dimensions / Overview

General Information

High-Back with Privacy Arms

- A. Seat Height
- B. Seat Depth
- C. Back Height
- D. Overall Height
- E. Overall Depth
- F. Overall Width

Single

- A. 16"
- B. 23.5"
- C. 28.5"
- D. 44.5"
- E. 33.75"
- F. 33.75"

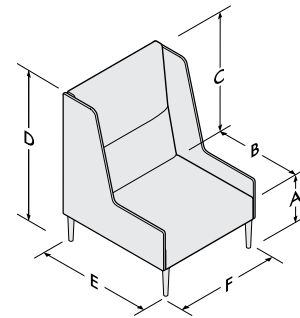

Double

- A. 16"
- B. 23.5"
- C. 28.5"
- D. 44.5"
- E. 33.75"
- F. 63.5"

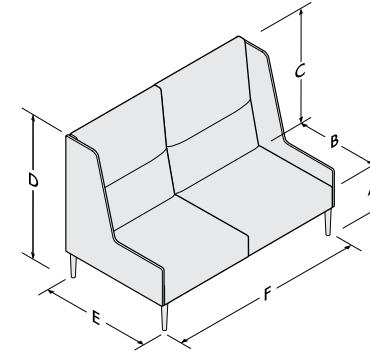

Triple

- A. 16"
- B. 23.5"
- C. 28.5"
- D. 44.5"
- E. 33.75"
- F. 93.25"

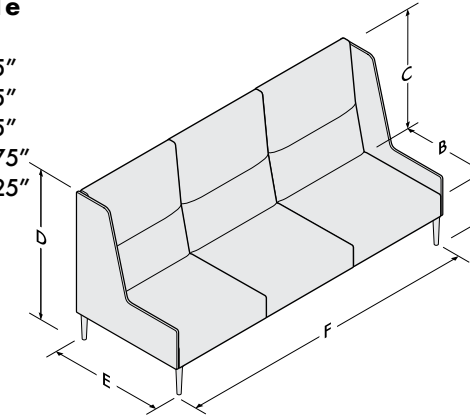

Design
Stylex

Construction

Multi-density, open-cell polyurethane foam is adhered to CARB-Certified internal plywood frame. All seat and back foam surfaces are overlaid with Dacron for enhanced feel and comfort. Dymetrol® webbing is used at the foundation of all seating surfaces to provide additional, flexible support.

Legs

Metrum is available with cast aluminum or wood legs. Cast aluminum legs may be powder coated in a variety of finishes, or ordered as polished cast aluminum. Wood legs are available in maple, white oak, and walnut. Adjustable glides are standard.

Tables

A selection of in-stock Caesarstone, solid surface, and wood tables is available.

Arms

Metrum offers two categories of arms – end arms that can only be added to the outside ends of a unit, and mid-arms that can be added between units in a continuous layout.

Configuration

While Metrum offers traditional stand-alone units (single seat, double seat, and triple seat), it is at the same time fundamentally flexible. The modular armless seats, corners, arms, and tables have all been designed to encourage creation of a wide variety of set-ups. Units next to each other in a continuous layout share a mid-leg that supports both units. To ensure clarity when ordering modular set-ups, it is critical that line items should be listed in the order in which they will be connected from left end (seated perspective) to right end.

Power

Optional power receptacles are available for surface mount in tables or undermounted on the front of seat units by either the left or right leg. Power units contain 2 USB ports and a standard, grounded 3-prong electrical outlet.

Testing

Manufactured to comply with ANSI/BIF-MA X5.4 Lounge Seating Tests.

Environment

Greenguard certified.

High-Back Armless

- A. Seat Height
- B. Seat Depth
- C. Back Height
- D. Overall Height
- E. Overall Depth
- F. Overall Width

Single

- A. 16"
- B. 23.5"
- C. 28.5"
- D. 44.5"
- E. 33.75"
- F. 29.75"

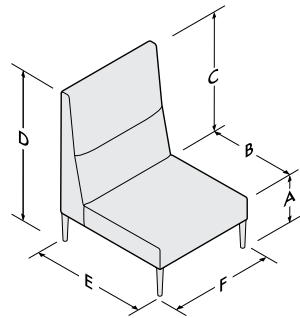

Double

- A. 16"
- B. 23.5"
- C. 28.5"
- D. 44.5"
- E. 33.75"
- F. 59.5"

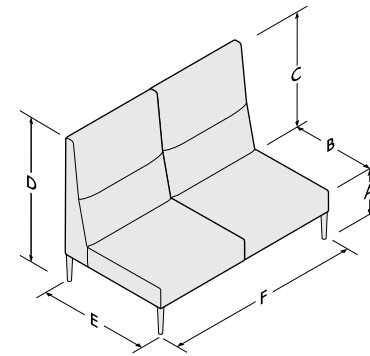

Triple

- A. 16"
- B. 23.5"
- C. 28.5"
- D. 44.5"
- E. 33.75"
- F. 89.25"

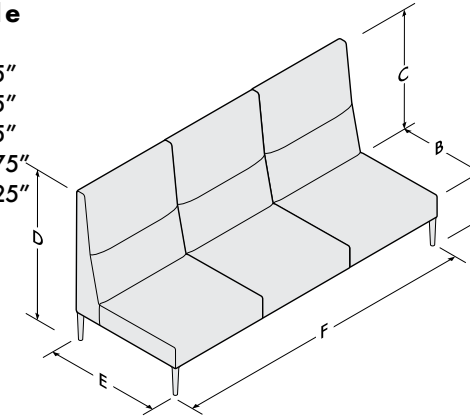

Product Information Applications:

Lounge

Dimensions / Overview

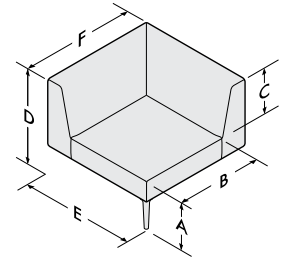
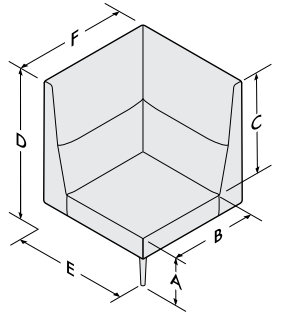
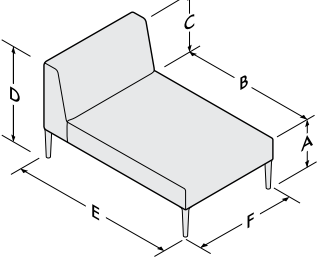
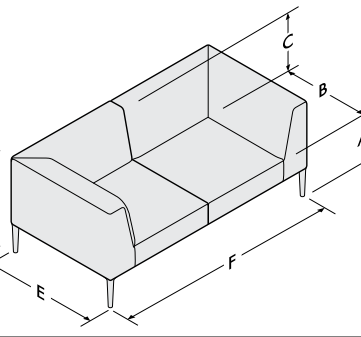
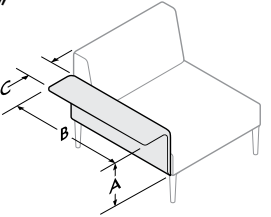
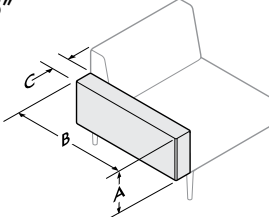
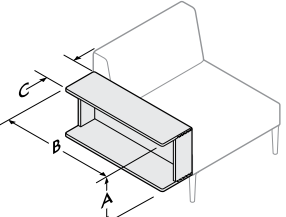
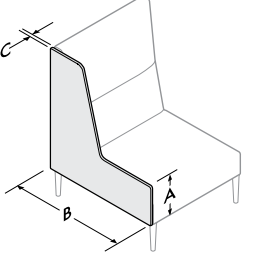
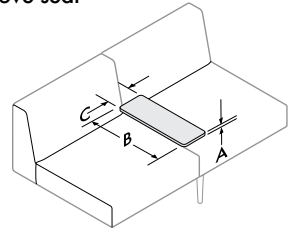
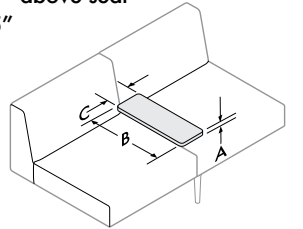
<p>High/Low-Back Corners A. Seat Height B. Seat Depth C. Back Height D. Overall Height E. Overall Depth F. Overall Width</p>	<p>Low-Back Corner A. 16" B. 23.5" C. 12" D. 28" E. 33.75" F. 33.75"</p> 	<p>High-Back Corner A. 16" B. 23.5" C. 28.5" D. 44.5" E. 33.75" F. 33.75"</p> 			<p>Design Stylex</p> <p>Construction Multi-density, open-cell polyurethane foam is adhered to CARB-Certified internal plywood frame. All seat and back foam surfaces are overlaid with Dacron for enhanced feel and comfort. Dymetrol® webbing is used at the foundation of all seating surfaces to provide additional, flexible support.</p>
<p>Low-Back Chaise A. Seat Height B. Seat Depth C. Back Height D. Overall Height E. Overall Depth F. Overall Width</p>	<p>A. 16" B. 38.5" C. 12" D. 28" E. 48.75" F. 29.75"</p> 				<p>Legs Metrum is available with cast aluminum or wood legs. Cast aluminum legs may be powder coated in a variety of finishes, or ordered as polished cast aluminum. Wood legs are available in maple, white oak, and walnut. Adjustable glides are standard.</p> <p>Tables A selection of in-stock Caesarstone, solid surface, and wood tables is available.</p> <p>Arms Metrum offers two categories of arms – end arms that can only be added to the outside ends of a unit, and mid-arms that can be added between units in a continuous layout.</p>
<p>Settee Double A. Seat Height B. Seat Depth C. Back Height D. Overall Height E. Overall Depth F. Overall Width</p>	<p>A. 16" B. 23.5" C. 12" D. 28" E. 33.75" F. 66.875"</p> 				<p>Configuration While Metrum offers traditional stand-alone units (single seat, double seat, and triple seat), it is at the same time fundamentally flexible. The modular armless seats, corners, arms, and tables have all been designed to encourage creation of a wide variety of set-ups. Units next to each other in a continuous layout share a mid-leg that supports both units. To ensure clarity when ordering modular set-ups, it is critical that line items should be listed in the order in which they will be connected from left end (seated perspective) to right end.</p>
<p>Arms A. Arm Height B. Arm Depth C. Arm Width</p>	<p>Cantilever A. 13.5" B. 33.25" C. 9.125"</p> 	<p>Standard A. 13" B. 33.75" C. 5.75"</p> 	<p>Bookshelf A. 14" B. 33" C. 10"</p> 	<p>Privacy A. 12" B. 33.5" C. 2"</p> 	<p>Power Optional power receptacles are available for surface mount in tables or undermounted on the front of seat units by either the left or right leg. Power units contain 2 USB ports and a standard, grounded 3-prong electrical outlet.</p>
	<p>Mid Arm Wood A. 3" above seat B. 22" C. 7.5"</p> 	<p>Mid Arm Upholstered A. 4.25" above seat B. 22.5" C. 8"</p> 			<p>Testing Manufactured to comply with ANSI/BIF-MA X5.4 Lounge Seating Tests.</p> <p>Environment Greenguard certified.</p>

Dimensions / Overview

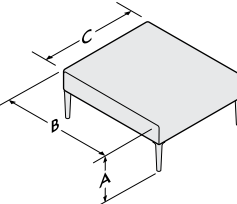
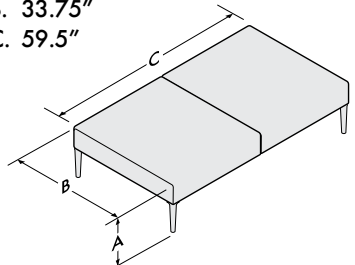
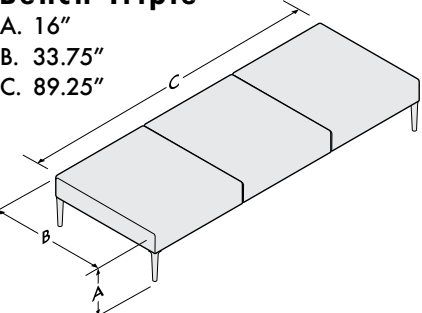
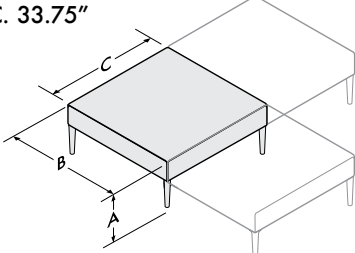
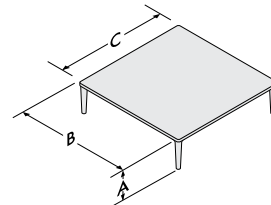
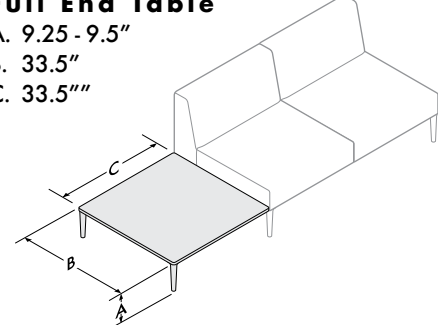
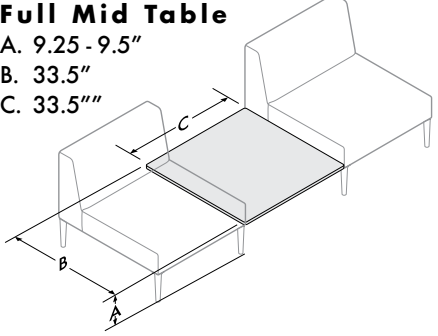
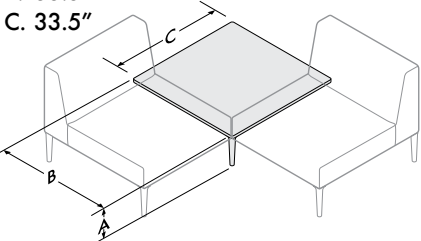
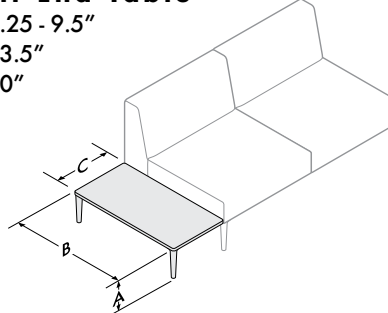
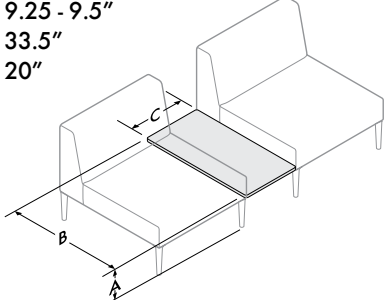
<p>Benches A. Bench Height B. Bench Depth C. Bench Width</p>	<p>Bench Single A. 16" B. 33.75" C. 29.75"</p> 	<p>Bench Double A. 16" B. 33.75" C. 59.5"</p> 	<p>Bench Triple A. 16" B. 33.75" C. 89.25"</p> 	<p>Bench Corner A. 16" B. 33.75" C. 33.75"</p> 	<p>Design Stylex</p> <p>Construction Multi-density, open-cell polyurethane foam is adhered to CARB-Certified internal plywood frame. All seat and back foam surfaces are overlaid with Dacron for enhanced feel and comfort. Dymetrol® webbing is used at the foundation of all seating surfaces to provide additional, flexible support.</p> <p>Legs Metrum is available with cast aluminum or wood legs. Cast aluminum legs may be powder coated in a variety of finishes, or ordered as polished cast aluminum. Wood legs are available in maple, white oak, and walnut. Adjustable glides are standard.</p> <p>Tables A selection of in-stock Caesarstone, solid surface, and wood tables is available.</p> <p>Arms Metrum offers two categories of arms - end arms that can only be added to the outside ends of a unit, and mid-arms that can be added between units in a continuous layout.</p> <p>Configuration While Metrum offers traditional stand-alone units (single seat, double seat, and triple seat), it is at the same time fundamentally flexible. The modular armless seats, corners, arms, and tables have all been designed to encourage creation of a wide variety of set-ups. Units next to each other in a continuous layout share a mid-leg that supports both units. To ensure clarity when ordering modular set-ups, it is critical that line items should be listed in the order in which they will be connected from left end (seated perspective) to right end.</p> <p>Power Optional power receptacles are available for surface mount in tables or undermounted on the front of seat units by either the left or right leg. Power units contain 2 USB ports and a standard, grounded 3-prong electrical outlet.</p> <p>Testing Manufactured to comply with ANSI/BIF-MA X5.4 Lounge Seating Tests.</p> <p>Environment Greenguard certified.</p>
<p>Full Tables A. Height B. Depth C. Width</p>	<p>Full Stand-Alone Table A. 9.25 - 9.5" B. 33.5" C. 33.5"</p> 	<p>Full End Table A. 9.25 - 9.5" B. 33.5" C. 33.5"</p> 	<p>Full Mid Table A. 9.25 - 9.5" B. 33.5" C. 33.5"</p> 	<p>Full Corner Table A. 9.25 - 9.5" B. 33.5" C. 33.5"</p> 	
<p>Half Tables A. Height B. Depth C. Width</p>	<p>Half End Table A. 9.25 - 9.5" B. 33.5" C. 20"</p> 	<p>Half Mid Table A. 9.25 - 9.5" B. 33.5" C. 20"</p> 			

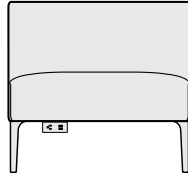
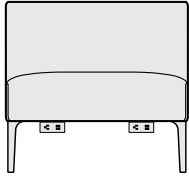
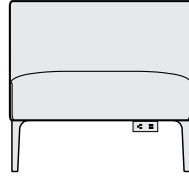
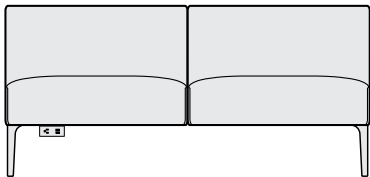
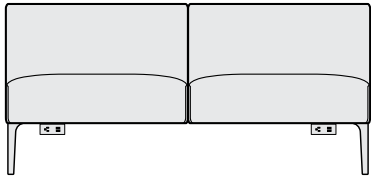
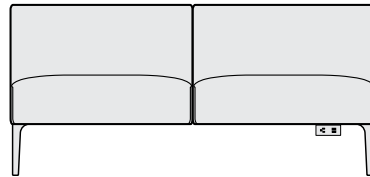
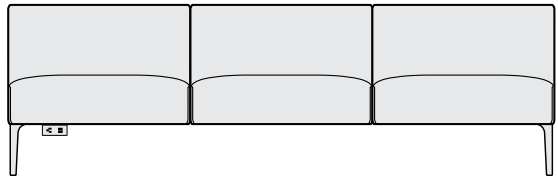
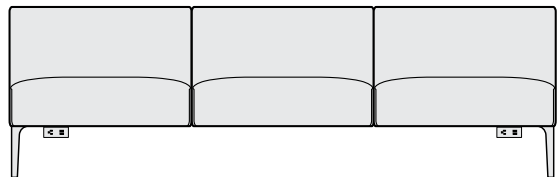
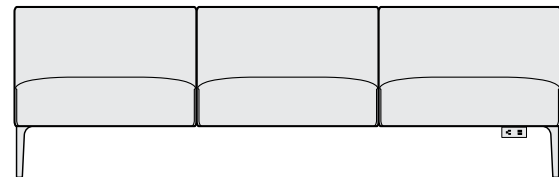
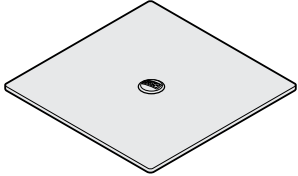
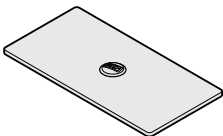
	Right Side	Double	Left Side	
Single Seating Power Port Option(s)				<p>Mounting Options Table surface mount power is designated by (S) in the model code. Power mounted under seat units is designated by (U) in the model code.</p> <p>Cord Length Table surface mount power is available with 10' or 20' cord. Power mounted under seat units has a 10' cord. 10' cord is designated by (1) and 20' cord is designated by (2).</p> <p>Colors Power units are available in black (B), white (W), and gray (G).</p> <p>Location Table surface mount power is centered on tables. Power mounted under seat units is located under the front edge next to the left leg (1), right leg (2), or both (3) from a seated perspective.</p> <p>Examples S2B - Table surface, 20' cord, Black U1W2 - Under Seat, 10' cord, White, Right Side.</p> <p>Restrictions Power is not available on corner seats or arms.</p>
Double Seating Power Port Option(s)				
Triple Seating Power Port Option(s)				
Full/Half Tables Power Port Option				
Power Port Ordering				

Power Options Seating

Power Options Tables



Power Options Seating

U1B1	Under Seat, 10' Cord, Black, Left	+450
U1B2	Under Seat, 10' Cord, Black, Right	+450
U1B3	Under Seat, 10' Cord, Black, Left & Right	+900
U1W1	Under Seat, 10' Cord, White, Left	+450
U1W2	Under Seat, 10' Cord, White, Right	+450
U1W3	Under Seat, 10' Cord, White, Left & Right	+900
U1G1	Under Seat, 10' Cord, Gray, Left	+450
U1G2	Under Seat, 10' Cord, Gray, Right	+450
U1G3	Under Seat, 10' Cord, Gray, Left & Right	+900

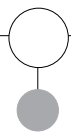

Power Options Tables

S1B	Table Surface, 10' Cord, Black	+450
S1W	Table Surface, 10' Cord, White	+450
S1G	Table Surface, 10' Cord, Gray	+450
S2B	Table Surface, 20' Cord, Black	+475
S2W	Table Surface, 20' Cord, White	+475
S2G	Table Surface, 20' Cord, Gray	+475

Metrum

Low-Back Single, Double and Triple with Cantilever Arms Lounge

C.O.M.
Fabric Upholstery
Grades

Series Model	Description/Yds.	C.O.M.	A	B	C	D	E	F	G	H	I	J	K	L	M
MT 11B41	Low-Back Single with Cantilever Arms C.O.M. yds. 3.8 Depth 33.75" Height 28" Seat Height 16" Width 48"	2,750	2,984	3,108	3,233	3,359	3,486	3,628	3,764	3,927	4,142	4,395	4,649	4,900	5,153
MT 12B41	Low-Back Double with Cantilever Arms C.O.M. yds. 5.9 Depth 33.75" Height 28" Seat Height 16" Width 77.75"	4,100	4,460	4,652	4,843	5,037	5,233	5,450	5,660	5,912	6,242	6,632	7,022	7,407	7,797
MT 13B41	Low-Back Triple with Cantilever Arms C.O.M. yds. 7.9 Depth 33.75" Height 28" Seat Height 16" Width 107.5"	5,300	5,780	6,036	6,291	6,549	6,811	7,100	7,380	7,716	8,156	8,676	9,196	9,709	10,229

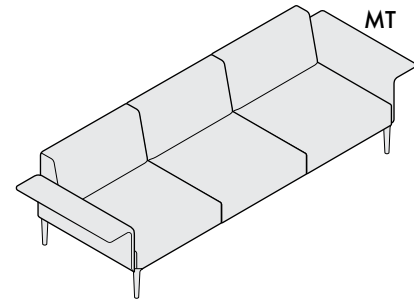
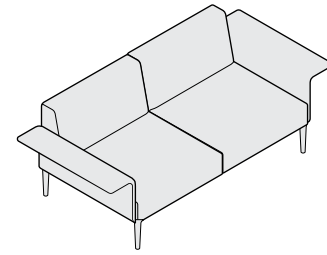
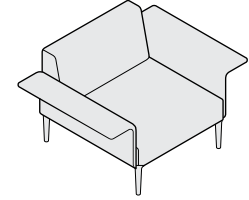

To Order follow steps 1-8

1 Series/Section 2 Arm Choice 3 Arm Finish Choices 4 Welt Cord Options 5 Power Options 6 Leg Choice 7 Leg Finish Choices 8 Fabrics

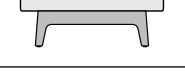
<p>MT</p> <p>11 Low-Back Single</p> <p>12 Low-Back Double</p> <p>13 Low-Back Triple</p>	<p>B41</p> <p>B41 Cantilever Arms</p> <p>Cantilever Arm</p> <table border="0"> <tr> <td>BM Black Matte</td> <td>NY Navy</td> </tr> <tr> <td>BT Black Twilight</td> <td>NK Nickel</td> </tr> <tr> <td>BL Blue</td> <td>OR Orange</td> </tr> <tr> <td>BR Brass</td> <td>PY Pale Yellow</td> </tr> <tr> <td>CP Champagne</td> <td>RD Red</td> </tr> <tr> <td>DB Dark Bronze</td> <td>RO Red Orange</td> </tr> <tr> <td>DG Dark Gray</td> <td>RR Rusty Red</td> </tr> <tr> <td>DP Dusty Pink</td> <td>SD Sand</td> </tr> <tr> <td>FG Forest Green</td> <td>SB Soft Blue</td> </tr> <tr> <td>LG Light Gray</td> <td>TC Terracotta</td> </tr> <tr> <td>MG Meadow Green</td> <td>TP Taupe</td> </tr> <tr> <td>MS Metallic Silver</td> <td>TS Textured Slate</td> </tr> <tr> <td>MK Milk</td> <td>YL Yellow</td> </tr> </table>	BM Black Matte	NY Navy	BT Black Twilight	NK Nickel	BL Blue	OR Orange	BR Brass	PY Pale Yellow	CP Champagne	RD Red	DB Dark Bronze	RO Red Orange	DG Dark Gray	RR Rusty Red	DP Dusty Pink	SD Sand	FG Forest Green	SB Soft Blue	LG Light Gray	TC Terracotta	MG Meadow Green	TP Taupe	MS Metallic Silver	TS Textured Slate	MK Milk	YL Yellow	<p>Welt Cord Options</p> <p>Requires an additional 0.25 yds of fabric. Not available on quilted fabric.</p> <p>W3 Welt Cord on Seats and Backs +65 (per seat/back)</p>	<p>Power Options</p> <table border="0"> <tr> <td>U1B1 Under Seat, 10' Cord, Black, Left</td> <td>+450</td> </tr> <tr> <td>U1B2 Under Seat, 10' Cord, Black, Right</td> <td>+450</td> </tr> <tr> <td>U1B3 Under Seat, 10' Cord, Black, Left & Right</td> <td>+900</td> </tr> <tr> <td>U1W1 Under Seat, 10' Cord, White, Left</td> <td>+450</td> </tr> <tr> <td>U1W2 Under Seat, 10' Cord, White, Right</td> <td>+450</td> </tr> <tr> <td>U1W3 Under Seat, 10' Cord, White, Left & Right</td> <td>+900</td> </tr> <tr> <td>U1G1 Under Seat, 10' Cord, Gray, Left</td> <td>+450</td> </tr> <tr> <td>U1G2 Under Seat, 10' Cord, Gray, Right</td> <td>+450</td> </tr> <tr> <td>U1G3 Under Seat, 10' Cord, Gray, Left & Right</td> <td>+900</td> </tr> </table>	U1B1 Under Seat, 10' Cord, Black, Left	+450	U1B2 Under Seat, 10' Cord, Black, Right	+450	U1B3 Under Seat, 10' Cord, Black, Left & Right	+900	U1W1 Under Seat, 10' Cord, White, Left	+450	U1W2 Under Seat, 10' Cord, White, Right	+450	U1W3 Under Seat, 10' Cord, White, Left & Right	+900	U1G1 Under Seat, 10' Cord, Gray, Left	+450	U1G2 Under Seat, 10' Cord, Gray, Right	+450	U1G3 Under Seat, 10' Cord, Gray, Left & Right	+900	<p>A Cast Aluminum legs with adjustable glides.</p> <p>W Wood legs with adjustable glides.</p> 	<p>AL Cast Aluminum - Polished</p> <p>Cast Aluminum - Standard Powder Paint</p> <table border="0"> <tr> <td>BM Black Matte</td> <td>NY Navy</td> </tr> <tr> <td>BT Black Twilight</td> <td>NK Nickel</td> </tr> <tr> <td>BL Blue</td> <td>OR Orange</td> </tr> <tr> <td>BR Brass</td> <td>PY Pale Yellow</td> </tr> <tr> <td>CP Champagne</td> <td>RD Red</td> </tr> <tr> <td>DB Dark Bronze</td> <td>RO Red Orange</td> </tr> <tr> <td>DG Dark Gray</td> <td>RR Rusty Red</td> </tr> <tr> <td>DP Dusty Pink</td> <td>SD Sand</td> </tr> <tr> <td>FG Forest Green</td> <td>SB Soft Blue</td> </tr> <tr> <td>LG Light Gray</td> <td>TC Terracotta</td> </tr> <tr> <td>MG Meadow Green</td> <td>TP Taupe</td> </tr> <tr> <td>MS Metallic Silver</td> <td>TS Textured Slate</td> </tr> <tr> <td>MK Milk</td> <td>YL Yellow</td> </tr> </table> <p>Wood</p> <table border="0"> <tr> <td>81 White Oak</td> <td>+640</td> </tr> <tr> <td>83 Natural Maple</td> <td>+550</td> </tr> <tr> <td>85 Walnut</td> <td>+720</td> </tr> </table>	BM Black Matte	NY Navy	BT Black Twilight	NK Nickel	BL Blue	OR Orange	BR Brass	PY Pale Yellow	CP Champagne	RD Red	DB Dark Bronze	RO Red Orange	DG Dark Gray	RR Rusty Red	DP Dusty Pink	SD Sand	FG Forest Green	SB Soft Blue	LG Light Gray	TC Terracotta	MG Meadow Green	TP Taupe	MS Metallic Silver	TS Textured Slate	MK Milk	YL Yellow	81 White Oak	+640	83 Natural Maple	+550	85 Walnut	+720	<p>Yardages provided are for non-directional fabrics that are applied railroaded. Directional fabrics may require additional yardage.</p> <p>Thick quilted fabrics will be need to be verified and may be handled as a custom order.</p> <p>Refer to Stylex swatch cards and separately published in-graded fabric program to determine grades.</p> <p>See general information section in the main price list for CAL 133 information.</p>
BM Black Matte	NY Navy																																																																																	
BT Black Twilight	NK Nickel																																																																																	
BL Blue	OR Orange																																																																																	
BR Brass	PY Pale Yellow																																																																																	
CP Champagne	RD Red																																																																																	
DB Dark Bronze	RO Red Orange																																																																																	
DG Dark Gray	RR Rusty Red																																																																																	
DP Dusty Pink	SD Sand																																																																																	
FG Forest Green	SB Soft Blue																																																																																	
LG Light Gray	TC Terracotta																																																																																	
MG Meadow Green	TP Taupe																																																																																	
MS Metallic Silver	TS Textured Slate																																																																																	
MK Milk	YL Yellow																																																																																	
U1B1 Under Seat, 10' Cord, Black, Left	+450																																																																																	
U1B2 Under Seat, 10' Cord, Black, Right	+450																																																																																	
U1B3 Under Seat, 10' Cord, Black, Left & Right	+900																																																																																	
U1W1 Under Seat, 10' Cord, White, Left	+450																																																																																	
U1W2 Under Seat, 10' Cord, White, Right	+450																																																																																	
U1W3 Under Seat, 10' Cord, White, Left & Right	+900																																																																																	
U1G1 Under Seat, 10' Cord, Gray, Left	+450																																																																																	
U1G2 Under Seat, 10' Cord, Gray, Right	+450																																																																																	
U1G3 Under Seat, 10' Cord, Gray, Left & Right	+900																																																																																	
BM Black Matte	NY Navy																																																																																	
BT Black Twilight	NK Nickel																																																																																	
BL Blue	OR Orange																																																																																	
BR Brass	PY Pale Yellow																																																																																	
CP Champagne	RD Red																																																																																	
DB Dark Bronze	RO Red Orange																																																																																	
DG Dark Gray	RR Rusty Red																																																																																	
DP Dusty Pink	SD Sand																																																																																	
FG Forest Green	SB Soft Blue																																																																																	
LG Light Gray	TC Terracotta																																																																																	
MG Meadow Green	TP Taupe																																																																																	
MS Metallic Silver	TS Textured Slate																																																																																	
MK Milk	YL Yellow																																																																																	
81 White Oak	+640																																																																																	
83 Natural Maple	+550																																																																																	
85 Walnut	+720																																																																																	

Metrum

Low-Back Single, Double and Triple
with Standard Upholstered Arms
Lounge

C.O.M.
Fabric Upholstery
Grades

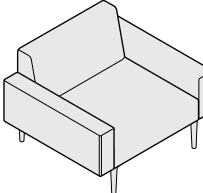
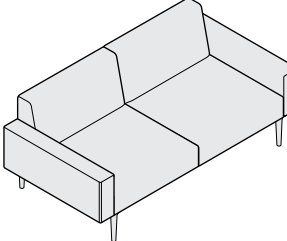
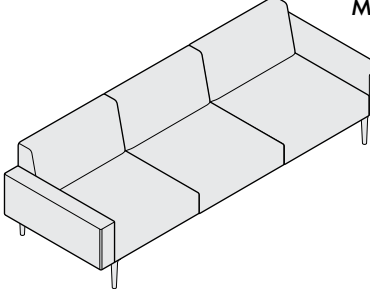
Series Model	Description/Yds.	C.O.M.	A	B	C	D	E	F	G	H	I	J	K	L	M
MT 11B44	Low-Back Single with Standard Arms  <p>C.O.M. yds. 5.5 Depth 33.75" Height 28" Seat Height 16" Width 41.25"</p>	2,490	2,832	3,014	3,197	3,379	3,568	3,774	3,972	4,211	4,526	4,895	5,267	5,632	6,001
MT 12B44	Low-Back Double with Standard Arms  <p>C.O.M. yds. 7.6 Depth 33.75" Height 28" Seat Height 16" Width 71"</p>	3,840	4,308	4,558	4,807	5,057	5,315	5,596	5,868	6,196	6,626	7,132	7,640	8,139	8,645
MT 13B44	Low-Back Triple with Standard Arms  <p>C.O.M. yds. 9.6 Depth 33.75" Height 28" Seat Height 16" Width 100.75"</p>	5,040	5,628	5,942	6,255	6,569	6,893	7,246	7,588	8,000	8,540	9,176	9,814	10,441	11,077

To Order follow steps 1-7

1 Series/Section 2 Arm Choice 3 Welt Cord Options 4 Power Options 5 Leg Choice 6 Leg Finish Choices 7 Fabrics

MT

- 11 Low-Back Single
- 12 Low-Back Double
- 13 Low-Back Triple

B44

B44 Standard Upholstered Arms

● **Welt Cord Options**
Requires an additional 0.25 yds of fabric. Not available on quilted fabric.

W3 Welt Cord on Seats and Backs +65 (per seat/back)

W5 Welt Cord on Seats, Backs & Arms +100 (arms) +65 (per seat/back)

● **Power Options**

U1B1 Under Seat, 10' Cord, Black, Left +450
U1B2 Under Seat, 10' Cord, Black, Right +450
U1B3 Under Seat, 10' Cord, Black, Left & Right +900
U1W1 Under Seat, 10' Cord, White, Left +450
U1W2 Under Seat, 10' Cord, White, Right +450
U1W3 Under Seat, 10' Cord, White, Left & Right +900
U1G1 Under Seat, 10' Cord, Gray, Left +450
U1G2 Under Seat, 10' Cord, Gray, Right +450
U1G3 Under Seat, 10' Cord, Gray, Left & Right +900

● **A** Cast Aluminum legs with adjustable glides.

● **W** Wood legs with adjustable glides.

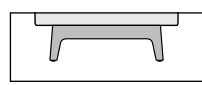

● **AL** **Cast Aluminum - Polished**

● **Cast Aluminum - Standard Powder Paint**

BM Black Matte	NY Navy
BT Black Twilight	NK Nickel
BL Blue	OR Orange
BR Brass	PY Pale Yellow
CP Champagne	RD Red
DB Dark Bronze	RO Red Orange
DG Dark Gray	RR Rusty Red
DP Dusty Pink	SD Sand
FG Forest Green	SB Soft Blue
LG Light Gray	TC Terracotta
MG Meadow Green	TP Taupe
MS Metallic Silver	TS Textured Slate
MK Milk	YL Yellow

● **Wood**

81 White Oak	+640
83 Natural Maple	+550
85 Walnut	+720

● Yardages provided are for non-directional fabrics that are applied railroaded. Directional fabrics may require additional yardage.

Thick quilted fabrics will be need to be verified and may be handled as a custom order.

Refer to Stylex swatch cards and separately published in-graded fabric program to determine grades.

See general information section in the main price list for CAL 133 information.

Metrum

High-Back Single, Double and Triple with Privacy Arms Lounge

C.O.M.
Fabric Upholstery
Grades

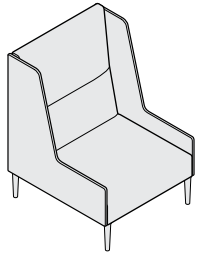
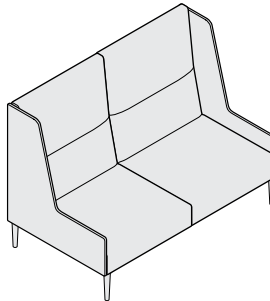
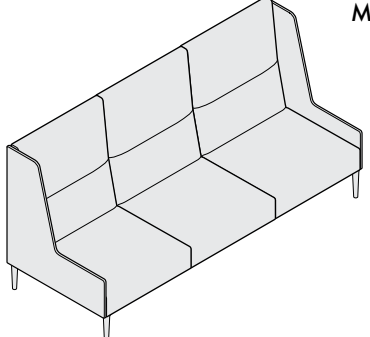
Series Model	Description/Yds.	C.O.M.	A	B	C	D	E	F	G	H	I	J	K	L	M	
	MT 21B43	High-Back Single with Privacy Arms	2,800	3,202	3,416	3,631	3,845	4,066	4,309	4,542	4,823	5,201	5,627	6,063	6,492	6,927
		C.O.M. yds.		6.6												
		Depth		33.75"												
		Height		44.5"												
		Seat Height		16"												
	Width		33.75"													
	MT 22B43	High-Back Double with Privacy Arms	4,400	4,976	5,282	5,591	5,897	6,214	6,561	6,896	7,298	7,827	8,450	9,075	9,690	10,313
		C.O.M. yds.		9.5												
		Depth		33.75"												
		Height		44.5"												
		Seat Height		16"												
	Width		63.5"													
	MT 23B43	High-Back Triple with Privacy Arms	5,900	6,644	7,040	7,438	7,834	8,243	8,691	9,124	9,644	10,327	11,132	11,939	12,733	13,538
		C.O.M. yds.		12.3												
		Depth		33.75"												
		Height		44.5"												
		Seat Height		16"												
	Width		93.25"													

To Order follow steps 1-7

1 Series/Section 2 Arm Choice 3 Welt Cord Options 4 Power Options 5 Leg Choice 6 Leg Finish Choices 7 Fabrics

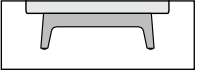
<p>MT</p> <p>21 High-Back Single</p> <p>22 High-Back Double</p> <p>23 High-Back Triple</p>	<p>B43</p> <p>B43 Privacy Arms</p>	<p>Welt Cord Options</p> <p>Requires an additional 0.25 yds of fabric. (0.5 yds for High-Back Triple) Not available on quilted fabric.</p> <p>W3 Welt Cord on Seats and Backs +70 (per seat/back)</p>	<p>Power Options</p> <p>U1B1 Under Seat, 10' Cord, Black, Left +450</p> <p>U1B2 Under Seat, 10' Cord, Black, Right +450</p> <p>U1B3 Under Seat, 10' Cord, Black, Left & Right +900</p> <p>U1W1 Under Seat, 10' Cord, White, Left +450</p> <p>U1W2 Under Seat, 10' Cord, White, Right +450</p> <p>U1W3 Under Seat, 10' Cord, White, Left & Right +900</p> <p>U1G1 Under Seat, 10' Cord, Gray, Left +450</p> <p>U1G2 Under Seat, 10' Cord, Gray, Right +450</p> <p>U1G3 Under Seat, 10' Cord, Gray, Left & Right +900</p>	<p>A Cast Aluminum legs with adjustable glides.</p> <p>W Wood legs with adjustable glides.</p> 	<p>AL Cast Aluminum - Polished</p> <p>Cast Aluminum - Standard Powder Paint</p> <table border="0"> <tr> <td>BM Black Matte</td> <td>NY Navy</td> </tr> <tr> <td>BT Black Twilight</td> <td>NK Nickel</td> </tr> <tr> <td>BL Blue</td> <td>OR Orange</td> </tr> <tr> <td>BR Brass</td> <td>PY Pale Yellow</td> </tr> <tr> <td>CP Champagne</td> <td>RD Red</td> </tr> <tr> <td>DB Dark Bronze</td> <td>RO Red Orange</td> </tr> <tr> <td>DG Dark Gray</td> <td>RR Rusty Red</td> </tr> <tr> <td>DP Dusty Pink</td> <td>SD Sand</td> </tr> <tr> <td>FG Forest Green</td> <td>SB Soft Blue</td> </tr> <tr> <td>LG Light Gray</td> <td>TC Terracotta</td> </tr> <tr> <td>MG Meadow Green</td> <td>TP Taupe</td> </tr> <tr> <td>MS Metallic Silver</td> <td>TS Textured Slate</td> </tr> <tr> <td>MK Milk</td> <td>YL Yellow</td> </tr> </table> <p>Wood</p> <table border="0"> <tr> <td>81 White Oak</td> <td>+640</td> </tr> <tr> <td>83 Natural Maple</td> <td>+550</td> </tr> <tr> <td>85 Walnut</td> <td>+720</td> </tr> </table>	BM Black Matte	NY Navy	BT Black Twilight	NK Nickel	BL Blue	OR Orange	BR Brass	PY Pale Yellow	CP Champagne	RD Red	DB Dark Bronze	RO Red Orange	DG Dark Gray	RR Rusty Red	DP Dusty Pink	SD Sand	FG Forest Green	SB Soft Blue	LG Light Gray	TC Terracotta	MG Meadow Green	TP Taupe	MS Metallic Silver	TS Textured Slate	MK Milk	YL Yellow	81 White Oak	+640	83 Natural Maple	+550	85 Walnut	+720	<p>Yardages provided are for non-directional fabrics that are applied railroaded. Directional fabrics may require additional yardage.</p> <p>Thick quilted fabrics will be need to be verified and may be handled as a custom order.</p> <p>Refer to Stylex swatch cards and separately published in-graded fabric program to determine grades.</p> <p>See general information section in the main price list for CAL 133 information.</p>
BM Black Matte	NY Navy																																					
BT Black Twilight	NK Nickel																																					
BL Blue	OR Orange																																					
BR Brass	PY Pale Yellow																																					
CP Champagne	RD Red																																					
DB Dark Bronze	RO Red Orange																																					
DG Dark Gray	RR Rusty Red																																					
DP Dusty Pink	SD Sand																																					
FG Forest Green	SB Soft Blue																																					
LG Light Gray	TC Terracotta																																					
MG Meadow Green	TP Taupe																																					
MS Metallic Silver	TS Textured Slate																																					
MK Milk	YL Yellow																																					
81 White Oak	+640																																					
83 Natural Maple	+550																																					
85 Walnut	+720																																					

Metrum

Low-Back Single, Double and Triple Armless Lounge

C.O.M.
Fabric Upholstery
Grades

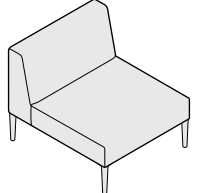
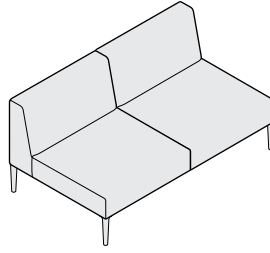
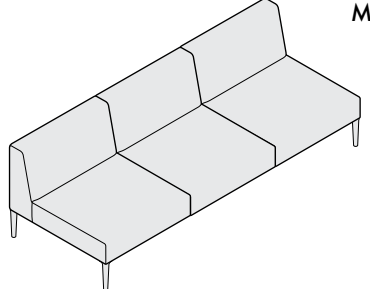
Series	Model	Description/Yds.	C.O.M.	A	B	C	D	E	F	G	H	I	J	K	L	M		
	MT	11	Low-Back Single	1,750	1,912	1,998	2,085	2,171	2,260	2,358	2,452	2,565	2,714	2,889	3,065	3,238	3,413	
			C.O.M. yds.	2.7														
			Depth	33.75"														
			Height	28"														
	MT	12	Low-Back Double	3,100	3,388	3,542	3,695	3,849	4,007	4,180	4,348	4,550	4,814	5,126	5,438	5,745	6,057	
			C.O.M. yds.	4.8														
			Depth	33.75"														
			Height	28"														
	MT	13	Low-Back Triple	4,300	4,708	4,926	5,143	5,361	5,585	5,830	6,068	6,354	6,728	7,170	7,612	8,047	8,489	
			C.O.M. yds.	6.8														
			Depth	33.75"														
			Height	28"														

To Order follow steps 1-7

1 Series/Section 2 Welt Cord Options 3 Upholstery Options 4 Power Options 5 Leg Choice 6 Leg Finish Choices 7 Fabrics

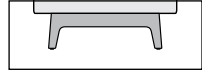
<p>MT</p> <p>11 Low-Back Single</p> <p>12 Low-Back Double</p> <p>13 Low-Back Triple</p>	<p>W3 Welt Cord on Seats and Backs +65 (per seat/back)</p>	<p>DF Dual Fabric</p> <p>The Dual Fabric Option allows for a second fabric to be applied to the seats. When specifying In-Graded fabrics, please apply the higher of the two grades.</p> <table border="0"> <tr> <td>Low-Back Single</td> <td></td> <td></td> </tr> <tr> <td>Fabric 1</td> <td>Seat</td> <td>1.6 yds.</td> </tr> <tr> <td>Fabric 2</td> <td>Back</td> <td>1.5 yds.</td> </tr> <tr> <td>Low-Back Double</td> <td></td> <td></td> </tr> <tr> <td>Fabric 1</td> <td>Seats</td> <td>2.6 yds.</td> </tr> <tr> <td>Fabric 2</td> <td>Backs</td> <td>2.2 yds.</td> </tr> <tr> <td>Low-Back Triple</td> <td></td> <td></td> </tr> <tr> <td>Fabric 1</td> <td>Seats</td> <td>3.6 yds.</td> </tr> <tr> <td>Fabric 2</td> <td>Backs</td> <td>3.3 yds.</td> </tr> </table>	Low-Back Single			Fabric 1	Seat	1.6 yds.	Fabric 2	Back	1.5 yds.	Low-Back Double			Fabric 1	Seats	2.6 yds.	Fabric 2	Backs	2.2 yds.	Low-Back Triple			Fabric 1	Seats	3.6 yds.	Fabric 2	Backs	3.3 yds.	<p>Power Options</p> <table border="0"> <tr> <td>U1B1</td> <td>Under Seat, 10' Cord, Black, Left</td> <td>+450</td> </tr> <tr> <td>U1B2</td> <td>Under Seat, 10' Cord, Black, Right</td> <td>+450</td> </tr> <tr> <td>U1B3</td> <td>Under Seat, 10' Cord, Black, Left & Right</td> <td>+900</td> </tr> <tr> <td>U1W1</td> <td>Under Seat, 10' Cord, White, Left</td> <td>+450</td> </tr> <tr> <td>U1W2</td> <td>Under Seat, 10' Cord, White, Right</td> <td>+450</td> </tr> <tr> <td>U1W3</td> <td>Under Seat, 10' Cord, White, Left & Right</td> <td>+900</td> </tr> <tr> <td>U1G1</td> <td>Under Seat, 10' Cord, Gray, Left</td> <td>+450</td> </tr> <tr> <td>U1G2</td> <td>Under Seat, 10' Cord, Gray, Right</td> <td>+450</td> </tr> <tr> <td>U1G3</td> <td>Under Seat, 10' Cord, Gray, Left & Right</td> <td>+900</td> </tr> </table>	U1B1	Under Seat, 10' Cord, Black, Left	+450	U1B2	Under Seat, 10' Cord, Black, Right	+450	U1B3	Under Seat, 10' Cord, Black, Left & Right	+900	U1W1	Under Seat, 10' Cord, White, Left	+450	U1W2	Under Seat, 10' Cord, White, Right	+450	U1W3	Under Seat, 10' Cord, White, Left & Right	+900	U1G1	Under Seat, 10' Cord, Gray, Left	+450	U1G2	Under Seat, 10' Cord, Gray, Right	+450	U1G3	Under Seat, 10' Cord, Gray, Left & Right	+900	<p>A Cast Aluminum legs with adjustable glides.</p> <p>W Wood legs with adjustable glides.</p> 	<p>AL Cast Aluminum - Polished</p> <p>Cast Aluminum - Standard Powder Paint</p> <table border="0"> <tr> <td>BM</td> <td>Black Matte</td> <td>NY</td> <td>Navy</td> </tr> <tr> <td>BT</td> <td>Black Twilight</td> <td>NK</td> <td>Nickel</td> </tr> <tr> <td>BL</td> <td>Blue</td> <td>OR</td> <td>Orange</td> </tr> <tr> <td>BR</td> <td>Brass</td> <td>PY</td> <td>Pale Yellow</td> </tr> <tr> <td>CP</td> <td>Champagne</td> <td>RD</td> <td>Red</td> </tr> <tr> <td>DB</td> <td>Dark Bronze</td> <td>RO</td> <td>Red Orange</td> </tr> <tr> <td>DG</td> <td>Dark Gray</td> <td>RR</td> <td>Rusty Red</td> </tr> <tr> <td>DP</td> <td>Dusty Pink</td> <td>SD</td> <td>Sand</td> </tr> <tr> <td>FG</td> <td>Forest Green</td> <td>SB</td> <td>Soft Blue</td> </tr> <tr> <td>LG</td> <td>Light Gray</td> <td>TC</td> <td>Terracotta</td> </tr> <tr> <td>MG</td> <td>Meadow Green</td> <td>TP</td> <td>Taupe</td> </tr> <tr> <td>MS</td> <td>Metallic Silver</td> <td>TS</td> <td>Textured Slate</td> </tr> <tr> <td>MK</td> <td>Milk</td> <td>YL</td> <td>Yellow</td> </tr> </table> <p>Wood</p> <table border="0"> <tr> <td>81</td> <td>White Oak</td> <td>+640</td> </tr> <tr> <td>83</td> <td>Natural Maple</td> <td>+550</td> </tr> <tr> <td>85</td> <td>Walnut</td> <td>+720</td> </tr> </table>	BM	Black Matte	NY	Navy	BT	Black Twilight	NK	Nickel	BL	Blue	OR	Orange	BR	Brass	PY	Pale Yellow	CP	Champagne	RD	Red	DB	Dark Bronze	RO	Red Orange	DG	Dark Gray	RR	Rusty Red	DP	Dusty Pink	SD	Sand	FG	Forest Green	SB	Soft Blue	LG	Light Gray	TC	Terracotta	MG	Meadow Green	TP	Taupe	MS	Metallic Silver	TS	Textured Slate	MK	Milk	YL	Yellow	81	White Oak	+640	83	Natural Maple	+550	85	Walnut	+720	<p>Yardages provided are for non-directional fabrics that are applied railroaded. Directional fabrics may require additional yardage.</p> <p>Thick quilted fabrics will be need to be verified and may be handled as a custom order.</p> <p>Refer to Stylex swatch cards and separately published in-graded fabric program to determine grades.</p> <p>See general information section in the main price list for CAL 133 information.</p>
Low-Back Single																																																																																																																									
Fabric 1	Seat	1.6 yds.																																																																																																																							
Fabric 2	Back	1.5 yds.																																																																																																																							
Low-Back Double																																																																																																																									
Fabric 1	Seats	2.6 yds.																																																																																																																							
Fabric 2	Backs	2.2 yds.																																																																																																																							
Low-Back Triple																																																																																																																									
Fabric 1	Seats	3.6 yds.																																																																																																																							
Fabric 2	Backs	3.3 yds.																																																																																																																							
U1B1	Under Seat, 10' Cord, Black, Left	+450																																																																																																																							
U1B2	Under Seat, 10' Cord, Black, Right	+450																																																																																																																							
U1B3	Under Seat, 10' Cord, Black, Left & Right	+900																																																																																																																							
U1W1	Under Seat, 10' Cord, White, Left	+450																																																																																																																							
U1W2	Under Seat, 10' Cord, White, Right	+450																																																																																																																							
U1W3	Under Seat, 10' Cord, White, Left & Right	+900																																																																																																																							
U1G1	Under Seat, 10' Cord, Gray, Left	+450																																																																																																																							
U1G2	Under Seat, 10' Cord, Gray, Right	+450																																																																																																																							
U1G3	Under Seat, 10' Cord, Gray, Left & Right	+900																																																																																																																							
BM	Black Matte	NY	Navy																																																																																																																						
BT	Black Twilight	NK	Nickel																																																																																																																						
BL	Blue	OR	Orange																																																																																																																						
BR	Brass	PY	Pale Yellow																																																																																																																						
CP	Champagne	RD	Red																																																																																																																						
DB	Dark Bronze	RO	Red Orange																																																																																																																						
DG	Dark Gray	RR	Rusty Red																																																																																																																						
DP	Dusty Pink	SD	Sand																																																																																																																						
FG	Forest Green	SB	Soft Blue																																																																																																																						
LG	Light Gray	TC	Terracotta																																																																																																																						
MG	Meadow Green	TP	Taupe																																																																																																																						
MS	Metallic Silver	TS	Textured Slate																																																																																																																						
MK	Milk	YL	Yellow																																																																																																																						
81	White Oak	+640																																																																																																																							
83	Natural Maple	+550																																																																																																																							
85	Walnut	+720																																																																																																																							

Metrum

High-Back Single, Double and Triple Armless Lounge

C.O.M.
Fabric Upholstery
Grades

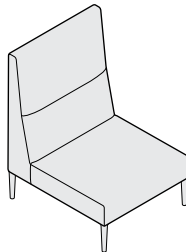
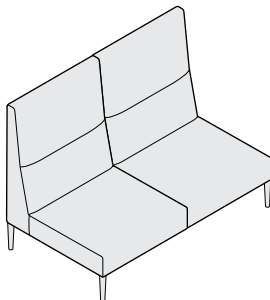
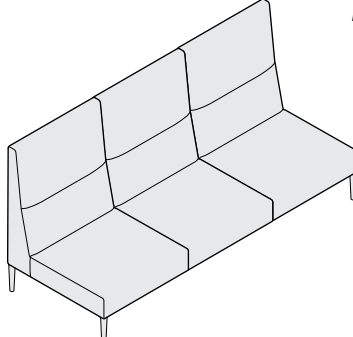
Series	Model	Description/Yds.	C.O.M.	A	B	C	D	E	F	G	H	I	J	K	L	M
	MT 21	High-Back Single	2,200	2,398	2,504	2,609	2,715	2,824	2,943	3,058	3,197	3,378	3,593	3,807	4,018	4,233
		C.O.M. yds.	3.3													
		Depth	33.75"													
		Height	44.5"													
	MT 22	High-Back Double	3,800	4,172	4,370	4,569	4,767	4,972	5,195	5,412	5,672	6,013	6,416	6,819	7,216	7,619
		C.O.M. yds.	6.2													
		Depth	33.75"													
		Height	44.5"													
	MT 23	High-Back Triple	5,300	5,840	6,128	6,416	6,704	7,001	7,325	7,640	8,018	8,513	9,098	9,683	10,259	10,844
		C.O.M. yds.	9.0													
		Depth	33.75"													
		Height	44.5"													

To Order follow steps 1-7

1 Series/Section 2 Welt Cord Options 3 Upholstery Options 4 Power Options 5 Leg Choice 6 Leg Finish Choices 7 Fabrics

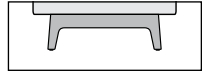
<p>MT</p> <p>21 High-Back Single</p> <p>22 High-Back Double</p> <p>23 High-Back Triple</p>	<p>W3 Welt Cord on Seats and Backs +70 (per seat/back)</p>	<p>DF Dual Fabric</p> <p>The Dual Fabric Option allows for a second fabric to be applied to the seats. When specifying In-Graded fabrics, please apply the higher of the two grades.</p> <table border="0"> <tr> <td>High-Back Single</td> <td>Fabric 1 Seat</td> <td>1.6 yds.</td> </tr> <tr> <td></td> <td>Fabric 2 Back</td> <td>2.5 yds.</td> </tr> <tr> <td>High-Back Double</td> <td>Fabric 1 Seats</td> <td>2.7 yds.</td> </tr> <tr> <td></td> <td>Fabric 2 Backs</td> <td>4.3 yds.</td> </tr> <tr> <td>High-Back Triple</td> <td>Fabric 1 Seats</td> <td>3.0 yds.</td> </tr> <tr> <td></td> <td>Fabric 2 Backs</td> <td>6.2 yds.</td> </tr> </table>	High-Back Single	Fabric 1 Seat	1.6 yds.		Fabric 2 Back	2.5 yds.	High-Back Double	Fabric 1 Seats	2.7 yds.		Fabric 2 Backs	4.3 yds.	High-Back Triple	Fabric 1 Seats	3.0 yds.		Fabric 2 Backs	6.2 yds.	<p>Power Options</p> <table border="0"> <tr> <td>U1B1 Under Seat, 10' Cord, Black, Left</td> <td>+450</td> </tr> <tr> <td>U1B2 Under Seat, 10' Cord, Black, Right</td> <td>+450</td> </tr> <tr> <td>U1B3 Under Seat, 10' Cord, Black, Left & Right</td> <td>+900</td> </tr> <tr> <td>U1W1 Under Seat, 10' Cord, White, Left</td> <td>+450</td> </tr> <tr> <td>U1W2 Under Seat, 10' Cord, White, Right</td> <td>+450</td> </tr> <tr> <td>U1W3 Under Seat, 10' Cord, White, Left & Right</td> <td>+900</td> </tr> <tr> <td>U1G1 Under Seat, 10' Cord, Gray, Left</td> <td>+450</td> </tr> <tr> <td>U1G2 Under Seat, 10' Cord, Gray, Right</td> <td>+450</td> </tr> <tr> <td>U1G3 Under Seat, 10' Cord, Gray, Left & Right</td> <td>+900</td> </tr> </table>	U1B1 Under Seat, 10' Cord, Black, Left	+450	U1B2 Under Seat, 10' Cord, Black, Right	+450	U1B3 Under Seat, 10' Cord, Black, Left & Right	+900	U1W1 Under Seat, 10' Cord, White, Left	+450	U1W2 Under Seat, 10' Cord, White, Right	+450	U1W3 Under Seat, 10' Cord, White, Left & Right	+900	U1G1 Under Seat, 10' Cord, Gray, Left	+450	U1G2 Under Seat, 10' Cord, Gray, Right	+450	U1G3 Under Seat, 10' Cord, Gray, Left & Right	+900	<p>A Cast Aluminum legs with adjustable glides.</p> <p>W Wood legs with adjustable glides.</p> 	<p>AL Cast Aluminum - Polished</p> <p>Cast Aluminum - Standard Powder Paint</p> <table border="0"> <tr> <td>BM Black Matte</td> <td>NY Navy</td> </tr> <tr> <td>BT Black Twilight</td> <td>NK Nickel</td> </tr> <tr> <td>BL Blue</td> <td>OR Orange</td> </tr> <tr> <td>BR Brass</td> <td>PY Pale Yellow</td> </tr> <tr> <td>CP Champagne</td> <td>RD Red</td> </tr> <tr> <td>DB Dark Bronze</td> <td>RO Red Orange</td> </tr> <tr> <td>DG Dark Gray</td> <td>RR Rusty Red</td> </tr> <tr> <td>DP Dusty Pink</td> <td>SD Sand</td> </tr> <tr> <td>FG Forest Green</td> <td>SB Soft Blue</td> </tr> <tr> <td>LG Light Gray</td> <td>TC Terracotta</td> </tr> <tr> <td>MG Meadow Green</td> <td>TP Taupe</td> </tr> <tr> <td>MS Metallic Silver</td> <td>TS Textured Slate</td> </tr> <tr> <td>MK Milk</td> <td>YL Yellow</td> </tr> </table> <p>Wood</p> <table border="0"> <tr> <td>81 White Oak</td> <td>+640</td> </tr> <tr> <td>83 Natural Maple</td> <td>+550</td> </tr> <tr> <td>85 Walnut</td> <td>+720</td> </tr> </table>	BM Black Matte	NY Navy	BT Black Twilight	NK Nickel	BL Blue	OR Orange	BR Brass	PY Pale Yellow	CP Champagne	RD Red	DB Dark Bronze	RO Red Orange	DG Dark Gray	RR Rusty Red	DP Dusty Pink	SD Sand	FG Forest Green	SB Soft Blue	LG Light Gray	TC Terracotta	MG Meadow Green	TP Taupe	MS Metallic Silver	TS Textured Slate	MK Milk	YL Yellow	81 White Oak	+640	83 Natural Maple	+550	85 Walnut	+720	<p>Yardages provided are for non-directional fabrics that are applied railroaded. Directional fabrics may require additional yardage.</p> <p>Thick quilted fabrics will be need to be verified and may be handled as a custom order.</p> <p>Refer to Stylex swatch cards and separately published in-graded fabric program to determine grades.</p> <p>See general information section in the main price list for CAL 133 information.</p>
High-Back Single	Fabric 1 Seat	1.6 yds.																																																																								
	Fabric 2 Back	2.5 yds.																																																																								
High-Back Double	Fabric 1 Seats	2.7 yds.																																																																								
	Fabric 2 Backs	4.3 yds.																																																																								
High-Back Triple	Fabric 1 Seats	3.0 yds.																																																																								
	Fabric 2 Backs	6.2 yds.																																																																								
U1B1 Under Seat, 10' Cord, Black, Left	+450																																																																									
U1B2 Under Seat, 10' Cord, Black, Right	+450																																																																									
U1B3 Under Seat, 10' Cord, Black, Left & Right	+900																																																																									
U1W1 Under Seat, 10' Cord, White, Left	+450																																																																									
U1W2 Under Seat, 10' Cord, White, Right	+450																																																																									
U1W3 Under Seat, 10' Cord, White, Left & Right	+900																																																																									
U1G1 Under Seat, 10' Cord, Gray, Left	+450																																																																									
U1G2 Under Seat, 10' Cord, Gray, Right	+450																																																																									
U1G3 Under Seat, 10' Cord, Gray, Left & Right	+900																																																																									
BM Black Matte	NY Navy																																																																									
BT Black Twilight	NK Nickel																																																																									
BL Blue	OR Orange																																																																									
BR Brass	PY Pale Yellow																																																																									
CP Champagne	RD Red																																																																									
DB Dark Bronze	RO Red Orange																																																																									
DG Dark Gray	RR Rusty Red																																																																									
DP Dusty Pink	SD Sand																																																																									
FG Forest Green	SB Soft Blue																																																																									
LG Light Gray	TC Terracotta																																																																									
MG Meadow Green	TP Taupe																																																																									
MS Metallic Silver	TS Textured Slate																																																																									
MK Milk	YL Yellow																																																																									
81 White Oak	+640																																																																									
83 Natural Maple	+550																																																																									
85 Walnut	+720																																																																									

Metrum

Low-Back Corner, Chaise and High-Back Corner Lounge

C.O.M.
Fabric Upholstery
Grades

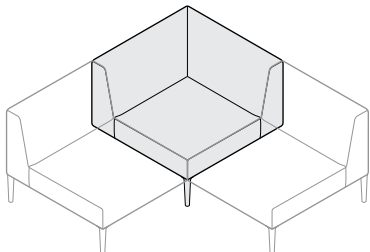
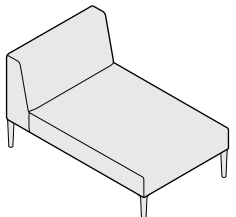
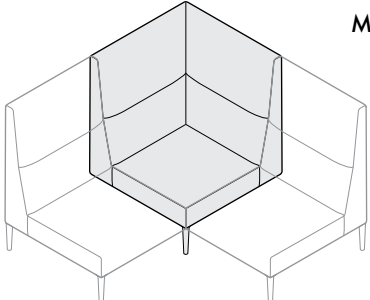
Series	Model	Description/Yds.	C.O.M.	A	B	C	D	E	F	G	H	I	J	K	L	M
	MT 14	Low-Back Corner	2,500	2,716	2,831	2,946	3,062	3,180	3,310	3,436	3,587	3,785	4,019	4,253	4,484	4,718
		C.O.M. yds. 3.6 Depth 33.5" Height 28" Seat Height 16" Width 33.5"														
	MT 15	Low-Back Chaise	2,050	2,248	2,354	2,459	2,565	2,674	2,793	2,908	3,047	3,228	3,443	3,657	3,868	4,083
		C.O.M. yds. 3.3 Depth 48.75" Height 28" Seat Height 16" Width 29.75"														
	MT 24	High-Back Corner	3,400	3,712	3,878	4,045	4,211	4,383	4,570	4,752	4,970	5,256	5,594	5,932	6,265	6,603
		C.O.M. yds. 5.2 Depth 33.5" Height 44.5" Seat Height 16" Width 33.5"														

To Order follow steps 1-7

1 Series/Section 2 Welt Cord Options 3 Upholstery Options 4 Power Options 5 Leg Choice 6 Leg Finish Choices 7 Fabrics

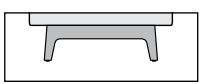
<p>MT</p> <ul style="list-style-type: none"> 14 Low-Back Corner 15 Low-Back Chaise 24 High-Back Corner 	<p>W3 Welt Cord on Seat and Back +95</p>	<p>DF Dual Fabric</p> <p>The Dual Fabric Option allows for a second fabric to be applied to the seats. When specifying In-Graded fabrics, please apply the higher of the two grades.</p> <table border="0"> <tr> <td>Low-Back Corner</td> <td>Fabric 1 Seat</td> <td>1.6 yds.</td> </tr> <tr> <td></td> <td>Fabric 2 Back</td> <td>2.4 yds.</td> </tr> <tr> <td>Low-Back Chaise</td> <td>Fabric 1 Seat</td> <td>2.4 yds.</td> </tr> <tr> <td></td> <td>Fabric 2 Back</td> <td>1.5 yds.</td> </tr> <tr> <td>High-Back Corner</td> <td>Fabric 1 Seat</td> <td>1.6 yds.</td> </tr> <tr> <td></td> <td>Fabric 2 Back</td> <td>4.3 yds.</td> </tr> </table>	Low-Back Corner	Fabric 1 Seat	1.6 yds.		Fabric 2 Back	2.4 yds.	Low-Back Chaise	Fabric 1 Seat	2.4 yds.		Fabric 2 Back	1.5 yds.	High-Back Corner	Fabric 1 Seat	1.6 yds.		Fabric 2 Back	4.3 yds.	<p>Power Options available on Chaise only</p> <table border="0"> <tr><td>U1B1 Under Seat, 10' Cord, Black, Left</td><td>+450</td></tr> <tr><td>U1B2 Under Seat, 10' Cord, Black, Right</td><td>+450</td></tr> <tr><td>U1B3 Under Seat, 10' Cord, Black, Left & Right</td><td>+900</td></tr> <tr><td>U1W1 Under Seat, 10' Cord, White, Left</td><td>+450</td></tr> <tr><td>U1W2 Under Seat, 10' Cord, White, Right</td><td>+450</td></tr> <tr><td>U1W3 Under Seat, 10' Cord, White, Left & Right</td><td>+900</td></tr> <tr><td>U1G1 Under Seat, 10' Cord, Gray, Left</td><td>+450</td></tr> <tr><td>U1G2 Under Seat, 10' Cord, Gray, Right</td><td>+450</td></tr> <tr><td>U1G3 Under Seat, 10' Cord, Gray, Left & Right</td><td>+900</td></tr> </table>	U1B1 Under Seat, 10' Cord, Black, Left	+450	U1B2 Under Seat, 10' Cord, Black, Right	+450	U1B3 Under Seat, 10' Cord, Black, Left & Right	+900	U1W1 Under Seat, 10' Cord, White, Left	+450	U1W2 Under Seat, 10' Cord, White, Right	+450	U1W3 Under Seat, 10' Cord, White, Left & Right	+900	U1G1 Under Seat, 10' Cord, Gray, Left	+450	U1G2 Under Seat, 10' Cord, Gray, Right	+450	U1G3 Under Seat, 10' Cord, Gray, Left & Right	+900	<p>A Cast Aluminum legs with adjustable glides.</p> <p>W Wood legs with adjustable glides.</p> 	<p>AL Cast Aluminum - Polished</p> <p>Cast Aluminum - Standard Powder Paint</p> <table border="0"> <tr><td>BM Black Matte</td><td>NY Navy</td></tr> <tr><td>BT Black Twilight</td><td>NK Nickel</td></tr> <tr><td>BL Blue</td><td>OR Orange</td></tr> <tr><td>BR Brass</td><td>PY Pale Yellow</td></tr> <tr><td>CP Champagne</td><td>RD Red</td></tr> <tr><td>DB Dark Bronze</td><td>RO Red Orange</td></tr> <tr><td>DG Dark Gray</td><td>RR Rusty Red</td></tr> <tr><td>DP Dusty Pink</td><td>SD Sand</td></tr> <tr><td>FG Forest Green</td><td>SB Soft Blue</td></tr> <tr><td>LG Light Gray</td><td>TC Terracotta</td></tr> <tr><td>MG Meadow Green</td><td>TP Taupe</td></tr> <tr><td>MS Metallic Silver</td><td>TS Textured Slate</td></tr> <tr><td>MK Milk</td><td>YL Yellow</td></tr> </table> <p>Wood</p> <table border="0"> <tr><td>81 White Oak</td><td>+640</td></tr> <tr><td>83 Natural Maple</td><td>+550</td></tr> <tr><td>85 Walnut</td><td>+720</td></tr> </table>	BM Black Matte	NY Navy	BT Black Twilight	NK Nickel	BL Blue	OR Orange	BR Brass	PY Pale Yellow	CP Champagne	RD Red	DB Dark Bronze	RO Red Orange	DG Dark Gray	RR Rusty Red	DP Dusty Pink	SD Sand	FG Forest Green	SB Soft Blue	LG Light Gray	TC Terracotta	MG Meadow Green	TP Taupe	MS Metallic Silver	TS Textured Slate	MK Milk	YL Yellow	81 White Oak	+640	83 Natural Maple	+550	85 Walnut	+720	<p>Yardages provided are for non-directional fabrics that are applied railroaded. Directional fabrics may require additional yardage.</p> <p>Thick quilted fabrics will be need to be verified and may be handled as a custom order.</p> <p>Refer to Stylex swatch cards and separately published in-graded fabric program to determine grades.</p> <p>See general information section in the main price list for CAL 133 information.</p>
Low-Back Corner	Fabric 1 Seat	1.6 yds.																																																																								
	Fabric 2 Back	2.4 yds.																																																																								
Low-Back Chaise	Fabric 1 Seat	2.4 yds.																																																																								
	Fabric 2 Back	1.5 yds.																																																																								
High-Back Corner	Fabric 1 Seat	1.6 yds.																																																																								
	Fabric 2 Back	4.3 yds.																																																																								
U1B1 Under Seat, 10' Cord, Black, Left	+450																																																																									
U1B2 Under Seat, 10' Cord, Black, Right	+450																																																																									
U1B3 Under Seat, 10' Cord, Black, Left & Right	+900																																																																									
U1W1 Under Seat, 10' Cord, White, Left	+450																																																																									
U1W2 Under Seat, 10' Cord, White, Right	+450																																																																									
U1W3 Under Seat, 10' Cord, White, Left & Right	+900																																																																									
U1G1 Under Seat, 10' Cord, Gray, Left	+450																																																																									
U1G2 Under Seat, 10' Cord, Gray, Right	+450																																																																									
U1G3 Under Seat, 10' Cord, Gray, Left & Right	+900																																																																									
BM Black Matte	NY Navy																																																																									
BT Black Twilight	NK Nickel																																																																									
BL Blue	OR Orange																																																																									
BR Brass	PY Pale Yellow																																																																									
CP Champagne	RD Red																																																																									
DB Dark Bronze	RO Red Orange																																																																									
DG Dark Gray	RR Rusty Red																																																																									
DP Dusty Pink	SD Sand																																																																									
FG Forest Green	SB Soft Blue																																																																									
LG Light Gray	TC Terracotta																																																																									
MG Meadow Green	TP Taupe																																																																									
MS Metallic Silver	TS Textured Slate																																																																									
MK Milk	YL Yellow																																																																									
81 White Oak	+640																																																																									
83 Natural Maple	+550																																																																									
85 Walnut	+720																																																																									

Metrum
Settee Double

Lounge

C.O.M.
Fabric Upholstery
Grades

Series	Model	Description/Yds.	C.O.M.	A	B	C	D	E	F	G	H	I	J	K	L	M
MT	32	Settee Double C.O.M. yds. 6.6 Depth 33.75" Height 28" Seat Height 16" Width 66.875"	4,200	4,596	4,807	5,018	5,230	5,447	5,685	5,916	6,193	6,556	6,985	7,414	7,837	8,266

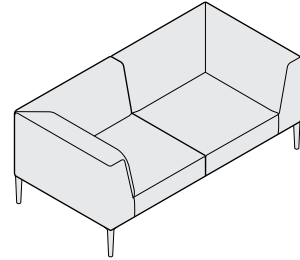

To Order follow steps 1-7

1 Series/Section	2 Welt Cord Options	3 Upholstery Options	4 Power Options	5 Leg Choice	6 Leg Finish Choices	7 Fabrics
<p>MT 32 Settee Double</p>	<p>W3 Welt Cord on Seat and Back +115</p>	<p>DF Dual Fabric The Dual Fabric Option allows for a second fabric to be applied to the seats. When specifying In-Graded fabrics, please apply the higher of the two grades. Settee Double Fabric 1 Seats 2.4 yds. Fabric 2 Backs 4.4 yds.</p>	<p>U1B1 Under Seat, 10' Cord, Black, Left +450 U1B2 Under Seat, 10' Cord, Black, Right +450 U1B3 Under Seat, 10' Cord, Black, Left & Right +900 U1W1 Under Seat, 10' Cord, White, Left +450 U1W2 Under Seat, 10' Cord, White, Right +450 U1W3 Under Seat, 10' Cord, White, Left & Right +900 U1G1 Under Seat, 10' Cord, Gray, Left +450 U1G2 Under Seat, 10' Cord, Gray, Right +450 U1G3 Under Seat, 10' Cord, Gray, Left & Right +900</p>	<p>A Cast Aluminum legs with adjustable glides. W Wood legs with adjustable glides.</p>	<p>AL Cast Aluminum - Polished Cast Aluminum - Standard Powder Paint BM Black Matte NY Navy BT Black Twilight NK Nickel BL Blue OR Orange BR Brass PY Pale Yellow CP Champagne RD Red DB Dark Bronze RO Red Orange DG Dark Gray RR Rusty Red DP Dusty Pink SD Sand FG Forest Green SB Soft Blue LG Light Gray TC Terracotta MG Meadow Green TP Taupe MS Metallic Silver TS Textured Slate MK Milk YL Yellow Wood 81 White Oak +640 83 Natural Maple +550 85 Walnut +720</p>	<p>Yardages provided are for non-directional fabrics that are applied railroaded. Directional fabrics may require additional yardage. Thick quilted fabrics will be need to be verified and may be handled as a custom order. Refer to Stylex swatch cards and separately published in-graded fabric program to determine grades. See general information section in the main price list for CAL 133 information.</p>

Metrum

Modular Benches

Lounge

C.O.M.
Fabric Upholstery
Grades

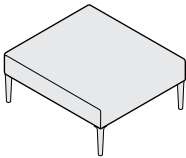
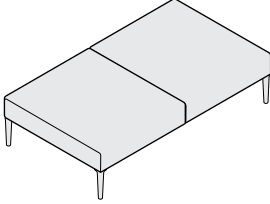
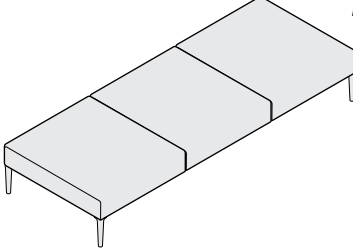
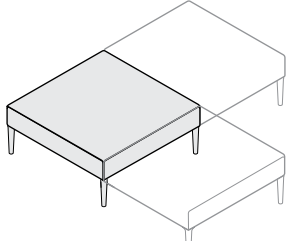
Series	Model	Description/Yds.	C.O.M.	A	B	C	D	E	F	G	H	I	J	K	L	M
	MT 01	Bench Single	1,175	1,301	1,368	1,435	1,503	1,572	1,648	1,721	1,809	1,925	2,061	2,198	2,332	2,469
		C.O.M. yds.	2.1													
		Depth	33.75"													
		Height	16"													
		Width	29.75"													
	MT 02	Bench Double	2,000	2,180	2,276	2,372	2,468	2,567	2,675	2,780	2,906	3,071	3,266	3,461	3,653	3,848
		C.O.M. yds.	3.0													
		Depth	33.75"													
		Height	16"													
		Width	59.5"													
	MT 03	Bench Triple	2,700	2,946	3,077	3,208	3,340	3,475	3,623	3,766	3,938	4,164	4,430	4,697	4,959	5,226
		C.O.M. yds..	4.1													
		Depth	33.75"													
		Height	16"													
		Width	89.25"													
	MT 04	Bench Corner	1,200	1,332	1,402	1,473	1,543	1,616	1,695	1,772	1,864	1,985	2,128	2,271	2,412	2,555
		C.O.M. yds.	2.2													
		Depth	33.5"													
		Height	16"													
		Width	33.5"													

To Order follow steps 1-6

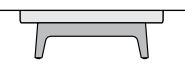
1 Series/Section	2 Welt Cord Options	3 Power Options	4 Leg Choice	5 Leg Finish Choices	6 Fabrics																																
<p>MT</p> <ul style="list-style-type: none"> 01 Bench Single 02 Bench Double 03 Bench Triple 04 Bench Corner 	<p>● Welt Cord Options Requires an additional 0.25 yds of fabric. Not available on quilted fabric.</p> <p>W1 Welt Cord on Seats +50 (per seat)</p>	<p>● Power Options</p> <ul style="list-style-type: none"> U1B1 Under Seat, 10' Cord, Black, Left +450 U1B2 Under Seat, 10' Cord, Black, Right +450 U1B3 Under Seat, 10' Cord, Black, Left & Right +900 U1W1 Under Seat, 10' Cord, White, Left +450 U1W2 Under Seat, 10' Cord, White, Right +450 U1W3 Under Seat, 10' Cord, White, Left & Right +900 U1G1 Under Seat, 10' Cord, Gray, Left +450 U1G2 Under Seat, 10' Cord, Gray, Right +450 U1G3 Under Seat, 10' Cord, Gray, Left & Right +900 <p>Not available on Bench Corner.</p>	<p>○ A Cast Aluminum legs with adjustable glides.</p> <p>○ W Wood legs with adjustable glides.</p> 	<p>○ AL Cast Aluminum - Polished</p> <p>● Cast Aluminum - Standard Powder Paint</p> <table border="0"> <tr><td>BM Black Matte</td><td>NY Navy</td></tr> <tr><td>BT Black Twilight</td><td>NK Nickel</td></tr> <tr><td>BL Blue</td><td>OR Orange</td></tr> <tr><td>BR Brass</td><td>PY Pale Yellow</td></tr> <tr><td>CP Champagne</td><td>RD Red</td></tr> <tr><td>DB Dark Bronze</td><td>RO Red Orange</td></tr> <tr><td>DG Dark Gray</td><td>RR Rusty Red</td></tr> <tr><td>DP Dusty Pink</td><td>SD Sand</td></tr> <tr><td>FG Forest Green</td><td>SB Soft Blue</td></tr> <tr><td>LG Light Gray</td><td>TC Terracotta</td></tr> <tr><td>MG Meadow Green</td><td>TP Taupe</td></tr> <tr><td>MS Metallic Silver</td><td>TS Textured Slate</td></tr> <tr><td>MK Milk</td><td>YL Yellow</td></tr> </table> <p>● Wood</p> <table border="0"> <tr><td>81 White Oak</td><td>+640</td></tr> <tr><td>83 Natural Maple</td><td>+550</td></tr> <tr><td>85 Walnut</td><td>+720</td></tr> </table>	BM Black Matte	NY Navy	BT Black Twilight	NK Nickel	BL Blue	OR Orange	BR Brass	PY Pale Yellow	CP Champagne	RD Red	DB Dark Bronze	RO Red Orange	DG Dark Gray	RR Rusty Red	DP Dusty Pink	SD Sand	FG Forest Green	SB Soft Blue	LG Light Gray	TC Terracotta	MG Meadow Green	TP Taupe	MS Metallic Silver	TS Textured Slate	MK Milk	YL Yellow	81 White Oak	+640	83 Natural Maple	+550	85 Walnut	+720	<p>● Yardages provided are for non-directional fabrics that are applied railroaded. Directional fabrics may require additional yardage.</p> <p>Thick quilted fabrics will be need to be verified and may be handled as a custom order.</p> <p>Refer to Stylex swatch cards and separately published in-graded fabric program to determine grades.</p> <p>See general information section in the main price list for CAL 133 information.</p>
BM Black Matte	NY Navy																																				
BT Black Twilight	NK Nickel																																				
BL Blue	OR Orange																																				
BR Brass	PY Pale Yellow																																				
CP Champagne	RD Red																																				
DB Dark Bronze	RO Red Orange																																				
DG Dark Gray	RR Rusty Red																																				
DP Dusty Pink	SD Sand																																				
FG Forest Green	SB Soft Blue																																				
LG Light Gray	TC Terracotta																																				
MG Meadow Green	TP Taupe																																				
MS Metallic Silver	TS Textured Slate																																				
MK Milk	YL Yellow																																				
81 White Oak	+640																																				
83 Natural Maple	+550																																				
85 Walnut	+720																																				

Metrum

Modular Arms

Lounge

C.O.M.
Fabric Upholstery
Grades

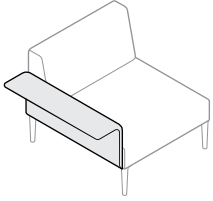
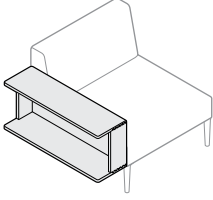
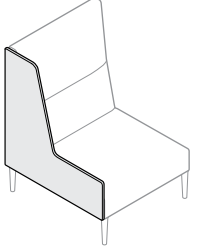
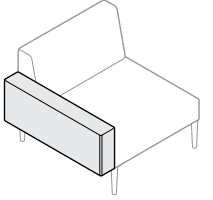
Series	Model	Description/Yds.	Wood Finish	C.O.M.	A	B	C	D	E	F	G	H	I	J	K	L	M
	MT 41	Cantilever Arm C.O.M. yds. 0.6 Depth 33.25" Height 13.5" Width 9.125"		500	536	555	574	594	613	635	656	681	714	753	792	831	870
	MT 42	Bookshelf Arm Depth 33" Height 14.0" Width 10"	White Oak 1,800 Natural Maple 2,000 Walnut 2,400														
	MT 43	Privacy Arm C.O.M. yds.. 1.7 Depth 33.5 Height 12" Width 2"		300	402	456	511	565	621	683	742	813	907	1,017	1,128	1,237	1,347
	MT 44	Standard Arm C.O.M. yds. 1.5 Depth 33.75" Height 13" Width 5.75"		370	460	508	556	604	654	708	760	823	906	1,003	1,101	1,197	1,294

To Order follow steps 1-5

1 Series/Section 2 Arm Orientation 3 Arm Finish Choices 4 Welt Cord Options 5 Fabrics

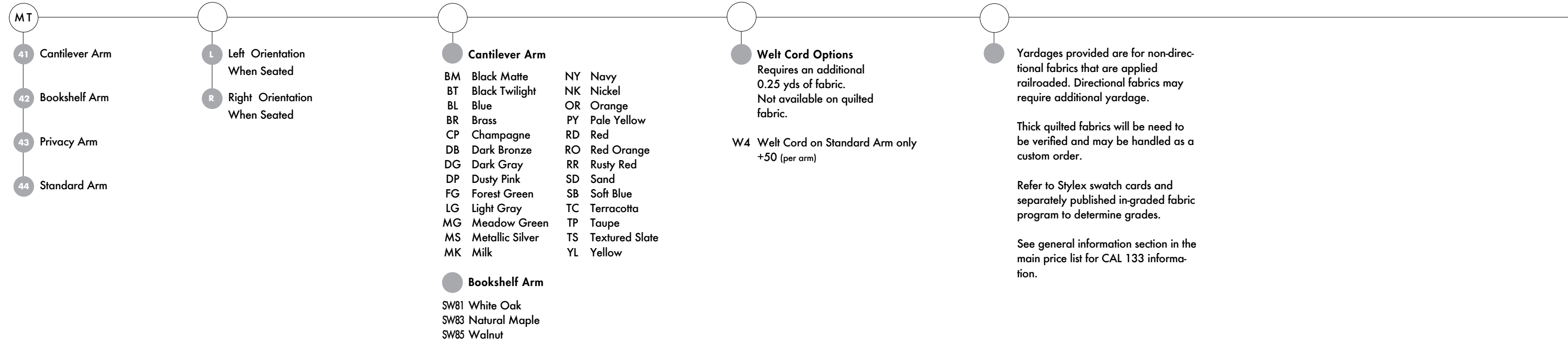

Metrum
Modular Mid Arms

Lounge

C.O.M.
Fabric Upholstery
Grades

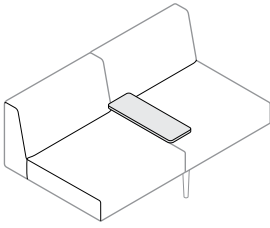
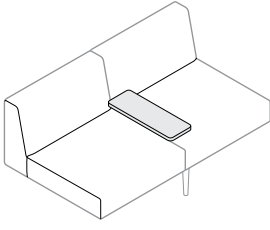
Series	Model	Description/Yds.	Wood Finish	C.O.M.	A	B	C	D	E	F	G	H	I	J	K	L	M	
	MT	45	Mid Arm Wood	White Oak 775 Natural Maple 800 Walnut 900														
			Depth 22" Height 3" Width 7.5"															
	MT	46	Mid Arm Upholstered		500	566	601	636	672	708	748	786	832	893	964	1,036	1,106	1,178
			C.O.M. yds.. 1.1 Depth 22.5" Height 4.25" Width 8"															

To Order follow steps 1-3

1 Series/Section 2 Arm Finish Choices 3 Fabrics

MT

45 Mid Arm Wood

46 Mid Arm Upholstered

○

● Wood Arm

SW81 White Oak
SW83 Natural Maple
SW85 Walnut

○

● Yardages provided are for non-directional fabrics that are applied railroaded. Directional fabrics may require additional yardage.

Thick quilted fabrics will be need to be verified and may be handled as a custom order.

Refer to Stylex swatch cards and separately published in-graded fabric program to determine grades.

See general information section in the main price list for CAL 133 information.

Metrum

Full Tables

Lounge

Table Material Selection

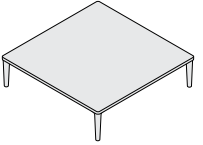
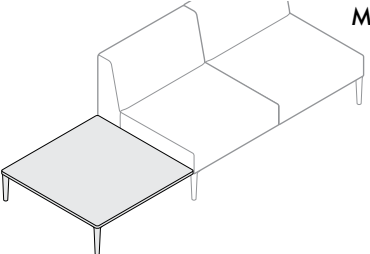
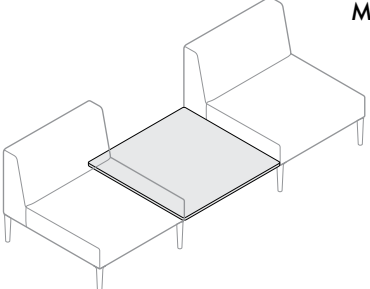
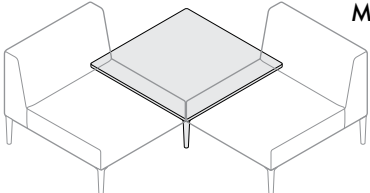
Series Model	Description	CS Caesarstone	SS Solid Surface	SW Solid Wood
 MT 51	Full Stand-Alone Table Depth 33.5" Height 9.25 - 9.5" Width 33.5"	51 Jet Black 3,800 52 Sleek Concrete 3,800 53 Haze 3,800 65 Pure White 4,900 96 Statuario Nuvo 6,200	01 Arctic White 2,000 03 Ivory White 2,000 04 Grey 2,550 05 Steel Grey 3,400 06 Black 3,000	81 White Oak 1,310 83 Natural Maple 1,180 85 Walnut 1,780
 MT 52	Full End Table Depth 33.5" Height 9.25 - 9.5" Width 33.5"	51 Jet Black 3,700 52 Sleek Concrete 3,700 53 Haze 3,700 65 Pure White 4,800 96 Statuario Nuvo 6,100	01 Arctic White 1,900 03 Ivory White 1,900 04 Grey 2,450 05 Steel Grey 3,300 06 Black 2,900	81 White Oak 1,210 83 Natural Maple 1,080 85 Walnut 1,680
 MT 53	Full Mid Table Depth 33.5" Height 9.25 - 9.5" Width 33.5"	51 Jet Black 3,700 52 Sleek Concrete 3,700 53 Haze 3,700 65 Pure White 4,800 96 Statuario Nuvo 6,100	01 Arctic White 1,900 03 Ivory White 1,900 04 Grey 2,450 05 Steel Grey 3,300 06 Black 2,900	81 White Oak 1,210 83 Natural Maple 1,080 85 Walnut 1,680
 MT 54	Full Corner Table Depth 33.5" Height 9.25 - 9.5" Width 33.5"	51 Jet Black 3,800 52 Sleek Concrete 3,800 53 Haze 3,800 65 Pure White 4,900 96 Statuario Nuvo 6,200	01 Arctic White 2,000 03 Ivory White 2,000 04 Grey 2,550 05 Steel Grey 3,400 06 Black 3,000	81 White Oak 1,310 83 Natural Maple 1,180 85 Walnut 1,780

To Order follow steps 1-5

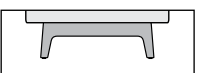
1 Series/Section	2 Table Material	3 Power Options	4 Leg Choice	5 Leg Finish Choices																																
<p>MT</p> <p>51 Full Stand-Alone Table</p> <p>52 Full End Table</p> <p>53 Full Mid Table</p> <p>54 Full Corner Table</p>	<p>Caesarstone Tops</p> <p>CS51 Jet Black CS52 Sleek Concrete CS53 Haze CS65 Pure White CS96 Statuario Nuvo</p> <p>Solid Surface Tops</p> <p>SS01 Arctic White SS03 Ivory White SS04 Grey SS05 Steel Grey SS06 Black</p> <p>Solid Wood Tops</p> <p>SW81 White Oak SW83 Natural Maple SW85 Walnut</p>	<p>Power Options</p> <p>S1B Table Surface, 10' Cord, Black +450 S1W Table Surface, 10' Cord, White +450 S1G Table Surface, 10' Cord, Gray +450</p> <p>S2B Table Surface, 20' Cord, Black +475 S2W Table Surface, 20' Cord, White +475 S2G Table Surface, 20' Cord, Gray +475</p>	<p>A Cast Aluminum legs with adjustable glides.</p> <p>W Wood legs with adjustable glides.</p> 	<p>AL Cast Aluminum - Polished</p> <p>Cast Aluminum - Standard Powder Paint</p> <table border="0"> <tr><td>BM Black Matte</td><td>NY Navy</td></tr> <tr><td>BT Black Twilight</td><td>NK Nickel</td></tr> <tr><td>BL Blue</td><td>OR Orange</td></tr> <tr><td>BR Brass</td><td>PY Pale Yellow</td></tr> <tr><td>CP Champagne</td><td>RD Red</td></tr> <tr><td>DB Dark Bronze</td><td>RO Red Orange</td></tr> <tr><td>DG Dark Gray</td><td>RR Rusty Red</td></tr> <tr><td>DP Dusty Pink</td><td>SD Sand</td></tr> <tr><td>FG Forest Green</td><td>SB Soft Blue</td></tr> <tr><td>LG Light Gray</td><td>TC Terracotta</td></tr> <tr><td>MG Meadow Green</td><td>TP Taupe</td></tr> <tr><td>MS Metallic Silver</td><td>TS Textured Slate</td></tr> <tr><td>MK Milk</td><td>YL Yellow</td></tr> </table> <p>Wood</p> <table border="0"> <tr><td>81 White Oak</td><td>+640</td></tr> <tr><td>83 Natural Maple</td><td>+550</td></tr> <tr><td>85 Walnut</td><td>+720</td></tr> </table>	BM Black Matte	NY Navy	BT Black Twilight	NK Nickel	BL Blue	OR Orange	BR Brass	PY Pale Yellow	CP Champagne	RD Red	DB Dark Bronze	RO Red Orange	DG Dark Gray	RR Rusty Red	DP Dusty Pink	SD Sand	FG Forest Green	SB Soft Blue	LG Light Gray	TC Terracotta	MG Meadow Green	TP Taupe	MS Metallic Silver	TS Textured Slate	MK Milk	YL Yellow	81 White Oak	+640	83 Natural Maple	+550	85 Walnut	+720
BM Black Matte	NY Navy																																			
BT Black Twilight	NK Nickel																																			
BL Blue	OR Orange																																			
BR Brass	PY Pale Yellow																																			
CP Champagne	RD Red																																			
DB Dark Bronze	RO Red Orange																																			
DG Dark Gray	RR Rusty Red																																			
DP Dusty Pink	SD Sand																																			
FG Forest Green	SB Soft Blue																																			
LG Light Gray	TC Terracotta																																			
MG Meadow Green	TP Taupe																																			
MS Metallic Silver	TS Textured Slate																																			
MK Milk	YL Yellow																																			
81 White Oak	+640																																			
83 Natural Maple	+550																																			
85 Walnut	+720																																			

Metrum

Half Tables

Lounge

Table Material Selection

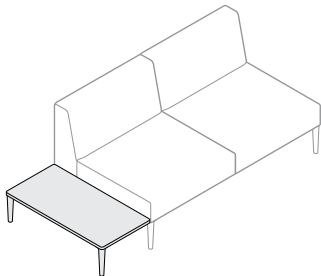
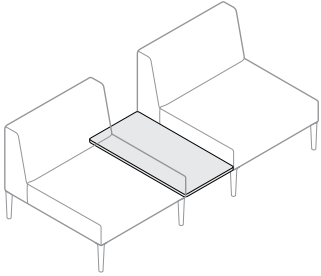
Series	Model	Description	CS Caesarstone	SS Solid Surface	SW Solid Wood
	MT 56	Half End Table Depth 33.5" Height 9.25 - 9.5" Width 20"	51 Jet Black 3,550 52 Sleek Concrete 3,550 53 Haze 3,550 65 Pure White 4,050 96 Statuario Nuvo 4,100	01 Arctic White 1,550 03 Ivory White 1,550 04 Grey 1,950 05 Steel Grey 2,700 06 Black 2,450	81 White Oak 880 83 Natural Maple 800 85 Walnut 1,190
		MT 57	Half Mid Table Depth 33.5" Height 9.25 - 9.5" Width 20"	51 Jet Black 3,550 52 Sleek Concrete 3,550 53 Haze 3,550 65 Pure White 4,050 96 Statuario Nuvo 4,100	01 Arctic White 1,550 03 Ivory White 1,550 04 Grey 1,950 05 Steel Grey 2,700 06 Black 2,450

To Order follow steps 1-5

1 Series/Section	2 Table Material	3 Power Options	4 Leg Choice	5 Leg Finish Choices
MT 56 Half End Table 57 Half Mid Table	Caesarstone Tops CS51 Jet Black CS52 Sleek Concrete CS53 Haze CS65 Pure White CS96 Statuario Nuvo Solid Surface Tops SS01 Arctic White SS03 Ivory White SS04 Grey SS05 Steel Grey SS06 Black Solid Wood Tops SW81 White Oak SW83 Natural Maple SW85 Walnut	Power Options S1B Table Surface, 10' Cord, Black +450 S1W Table Surface, 10' Cord, White +450 S1G Table Surface, 10' Cord, Gray +450 S2B Table Surface, 20' Cord, Black +475 S2W Table Surface, 20' Cord, White +475 S2G Table Surface, 20' Cord, Gray +475	Leg Choice A Cast Aluminum legs with adjustable glides. W Wood legs with adjustable glides.	Leg Finish Choices AL Cast Aluminum - Polished Cast Aluminum - Standard Powder Paint BM Black Matte NY Navy BT Black Twilight NK Nickel BL Blue OR Orange BR Brass PY Pale Yellow CP Champagne RD Red DB Dark Bronze RO Red Orange DG Dark Gray RR Rusty Red DP Dusty Pink SD Sand FG Forest Green SB Soft Blue LG Light Gray TC Terracotta MG Meadow Green TP Taupe MS Metallic Silver TS Textured Slate MK Milk YL Yellow Wood 81 White Oak +640 83 Natural Maple +550 85 Walnut +720