

Prices Effective  
September 1, 2018

# STREETX

**Metrum**

**Price List**

**Product Information Applications:**

Lounge

**Dimensions / Overview** **General Information**

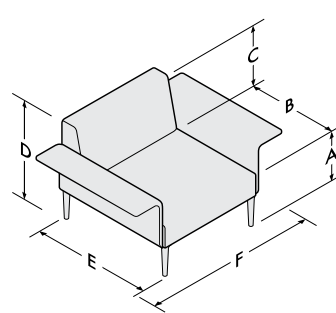
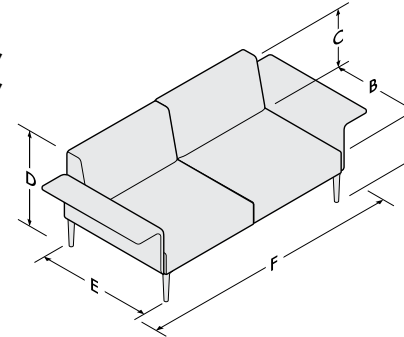
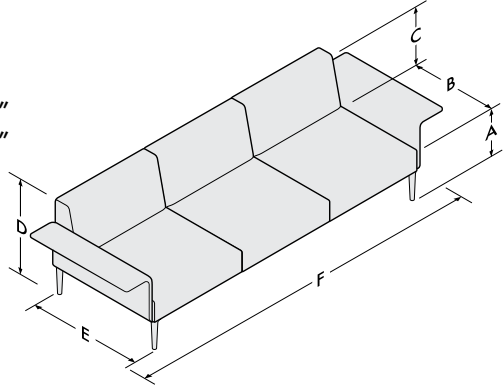
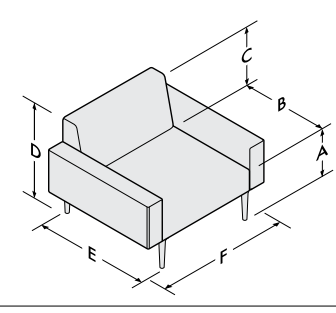
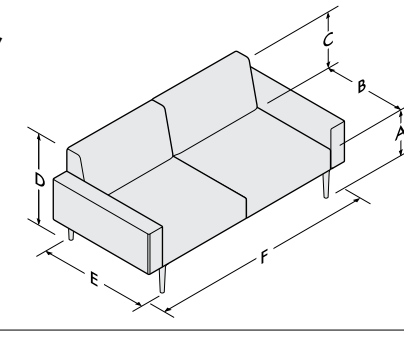
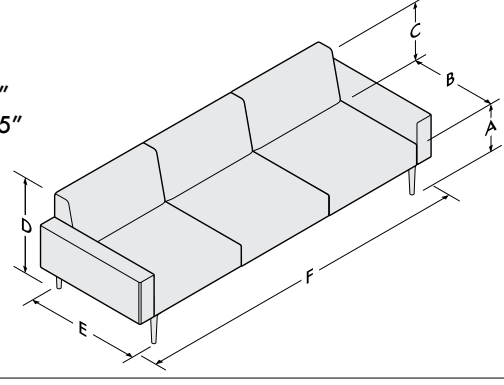
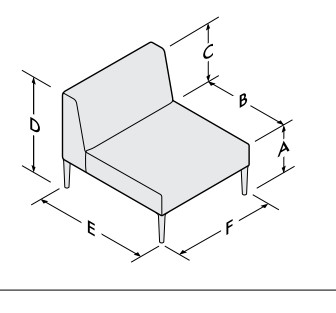
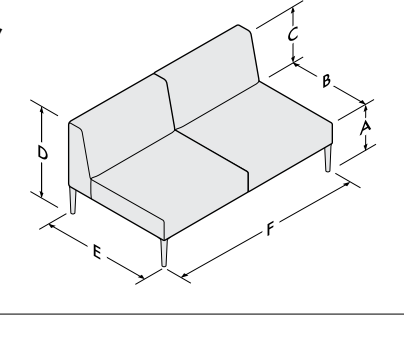
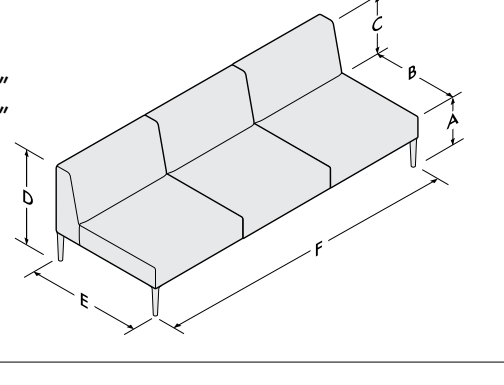
<p><b>Low-Back with Cantilever Arms</b></p> <p>A. Seat Height B. Seat Depth C. Back Height D. Overall Height E. Overall Depth F. Overall Width</p>	<p><b>Single</b></p> <p>A. 16" B. 23.5" C. 12" D. 28" E. 33.75" F. 48"</p> 	<p><b>Double</b></p> <p>A. 16" B. 23.5" C. 12" D. 28" E. 33.75" F. 77.75"</p> 	<p><b>Triple</b></p> <p>A. 16" B. 23.5" C. 12" D. 28" E. 33.75" F. 107.5"</p> 	<p><b>Design</b> Stylex</p> <p><b>Construction</b> Multi-density, open-cell polyurethane foam is adhered to CARB-Certified internal plywood frame. All seat and back foam surfaces are overlaid with Dacron for enhanced feel and comfort. Dymetrol® webbing is used at the foundation of all seating surfaces to provide additional, flexible support.</p> <p><b>Legs</b> Metrum is available with cast aluminum or wood legs. Cast aluminum legs may be powder coated in a variety of finishes, or ordered as polished cast aluminum. Wood legs are available in maple, white oak, and walnut. Adjustable glides are standard.</p> <p><b>Tables</b> A selection of in-stock Caesarstone, solid surface, and wood tables is available.</p> <p><b>Arms</b> Metrum offers two categories of arms – end arms that can only be added to the outside ends of a unit, and mid-arms that can be added between units in a continuous layout.</p> <p><b>Configuration</b> While Metrum offers traditional stand-alone units (single seat, double seat, and triple seat), it is at the same time fundamentally flexible. The modular armless seats, corners, arms, and tables have all been designed to encourage creation of a wide variety of set-ups. Units next to each other in a continuous layout share a mid-leg that supports both units. To ensure clarity when ordering modular set-ups, it is critical that line items should be listed in the order in which they will be connected from left end (seated perspective) to right end.</p> <p><b>Power</b> Optional power receptacles are available for surface mount in tables or undermounted on the front of seat units by either the left or right leg. Power units contain 2 USB ports and a standard, grounded 3-prong electrical outlet.</p> <p><b>Testing</b> Manufactured to comply with ANSI/BIF-MA X5.4 Lounge Seating Tests.</p> <p><b>Environment</b> Greenguard certified.</p>
<p><b>Low-Back with Standard Arms</b></p> <p>A. Seat Height B. Seat Depth C. Back Height D. Overall Height E. Overall Depth F. Overall Width</p>	<p><b>Single</b></p> <p>A. 16" B. 23.5" C. 12" D. 28" E. 33.75" F. 41.25"</p> 	<p><b>Double</b></p> <p>A. 16" B. 23.5" C. 12" D. 28" E. 33.75" F. 71"</p> 	<p><b>Triple</b></p> <p>A. 16" B. 23.5" C. 12" D. 28" E. 33.75" F. 100.75"</p> 	
<p><b>Low-Back Armless</b></p> <p>A. Seat Height B. Seat Depth C. Back Height D. Overall Height E. Overall Depth F. Overall Width</p>	<p><b>Single</b></p> <p>A. 16" B. 23.5" C. 12" D. 28" E. 33.75" F. 29.75"</p> 	<p><b>Double</b></p> <p>A. 16" B. 23.5" C. 12" D. 28" E. 33.75" F. 59.5"</p> 	<p><b>Triple</b></p> <p>A. 16" B. 23.5" C. 12" D. 28" E. 33.75" F. 89.25"</p> 	

**Product Information Applications:**

Lounge

**Dimensions / Overview**

**General Information**

**High-Back with Privacy Arms**

- A. Seat Height
- B. Seat Depth
- C. Back Height
- D. Overall Height
- E. Overall Depth
- F. Overall Width

**Single**

- A. 16"
- B. 23.5"
- C. 28.5"
- D. 44.5"
- E. 33.75"
- F. 33.75"

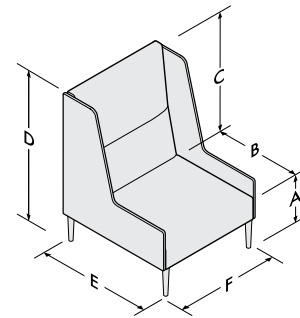

**Double**

- A. 16"
- B. 23.5"
- C. 28.5"
- D. 44.5"
- E. 33.75"
- F. 63.5"

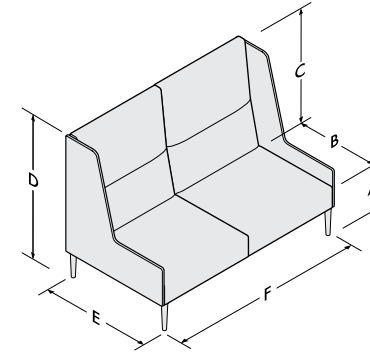

**Triple**

- A. 16"
- B. 23.5"
- C. 28.5"
- D. 44.5"
- E. 33.75"
- F. 93.25"

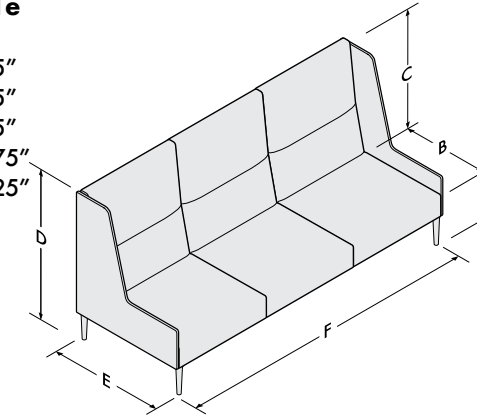

**Design**  
Stylex

**Construction**

Multi-density, open-cell polyurethane foam is adhered to CARB-Certified internal plywood frame. All seat and back foam surfaces are overlaid with Dacron for enhanced feel and comfort. Dymetrol® webbing is used at the foundation of all seating surfaces to provide additional, flexible support.

**Legs**

Metrum is available with cast aluminum or wood legs. Cast aluminum legs may be powder coated in a variety of finishes, or ordered as polished cast aluminum. Wood legs are available in maple, white oak, and walnut. Adjustable glides are standard.

**Tables**

A selection of in-stock Caesarstone, solid surface, and wood tables is available.

**Arms**

Metrum offers two categories of arms – end arms that can only be added to the outside ends of a unit, and mid-arms that can be added between units in a continuous layout.

**Configuration**

While Metrum offers traditional stand-alone units (single seat, double seat, and triple seat), it is at the same time fundamentally flexible. The modular armless seats, corners, arms, and tables have all been designed to encourage creation of a wide variety of set-ups. Units next to each other in a continuous layout share a mid-leg that supports both units. To ensure clarity when ordering modular set-ups, it is critical that line items should be listed in the order in which they will be connected from left end (seated perspective) to right end.

**Power**

Optional power receptacles are available for surface mount in tables or undermounted on the front of seat units by either the left or right leg. Power units contain 2 USB ports and a standard, grounded 3-prong electrical outlet.

**Testing**

Manufactured to comply with ANSI/BIF-MA X5.4 Lounge Seating Tests.

**Environment**

Greenguard certified.

**High-Back Armless**

- A. Seat Height
- B. Seat Depth
- C. Back Height
- D. Overall Height
- E. Overall Depth
- F. Overall Width

**Single**

- A. 16"
- B. 23.5"
- C. 28.5"
- D. 44.5"
- E. 33.75"
- F. 29.75"

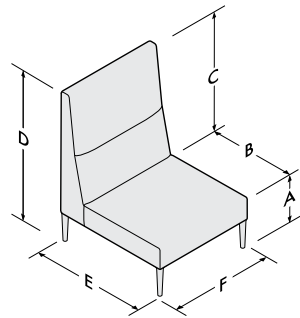

**Double**

- A. 16"
- B. 23.5"
- C. 28.5"
- D. 44.5"
- E. 33.75"
- F. 59.5"

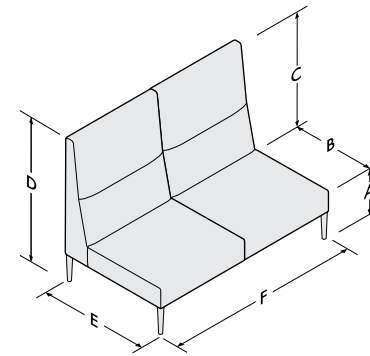

**Triple**

- A. 16"
- B. 23.5"
- C. 28.5"
- D. 44.5"
- E. 33.75"
- F. 89.25"

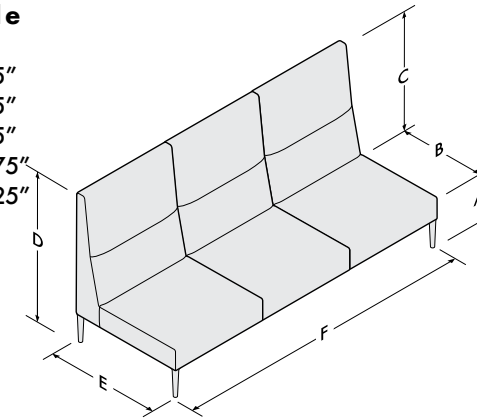

**Product Information Applications:**

Lounge

**Dimensions / Overview**

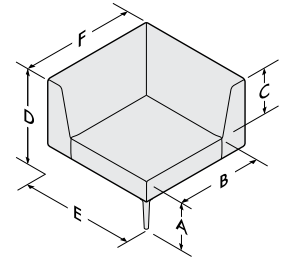
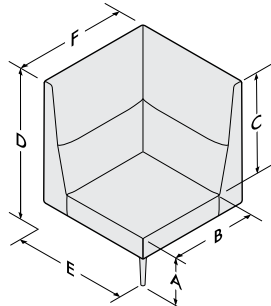
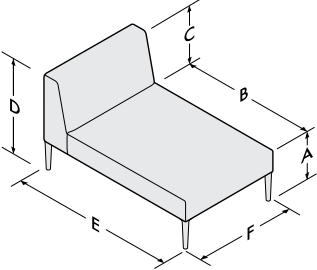
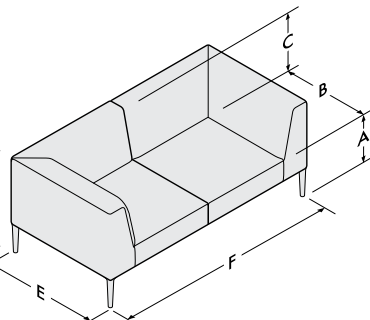
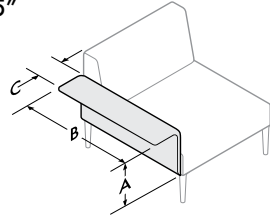
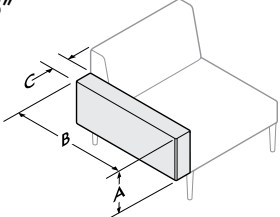
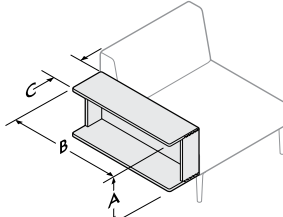
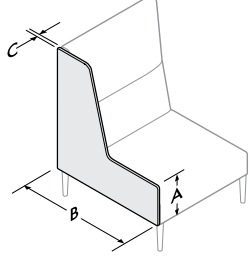
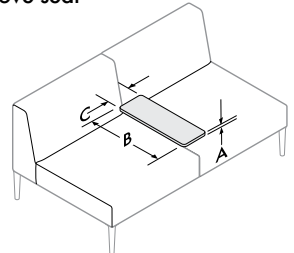
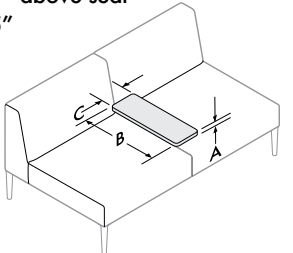
<p><b>High/Low-Back Corners</b>                  A. Seat Height                  B. Seat Depth                  C. Back Height                  D. Overall Height                  E. Overall Depth                  F. Overall Width</p>	<p><b>Low-Back Corner</b>                  A. 16"                  B. 23.5"                  C. 12"                  D. 28"                  E. 33.5"                  F. 33.5"</p> 	<p><b>High-Back Corner</b>                  A. 16"                  B. 23.5"                  C. 28.5"                  D. 44.5"                  E. 33.5"                  F. 33.5"</p> 			<p><b>Design</b>                  Stylex</p> <p><b>Construction</b>                  Multi-density, open-cell polyurethane foam is adhered to CARB-Certified internal plywood frame. All seat and back foam surfaces are overlaid with Dacron for enhanced feel and comfort. Dymetrol® webbing is used at the foundation of all seating surfaces to provide additional, flexible support.</p>
<p><b>Low-Back Chaise</b>                  A. Seat Height                  B. Seat Depth                  C. Back Height                  D. Overall Height                  E. Overall Depth                  F. Overall Width</p>	<p>A. 16"                  B. 38.5"                  C. 12"                  D. 28"                  E. 48.75"                  F. 29.75"</p> 				<p><b>Legs</b>                  Metrum is available with cast aluminum or wood legs. Cast aluminum legs may be powder coated in a variety of finishes, or ordered as polished cast aluminum. Wood legs are available in maple, white oak, and walnut. Adjustable glides are standard.</p> <p><b>Tables</b>                  A selection of in-stock Caesarstone, solid surface, and wood tables is available.</p>
<p><b>Settee Double</b>                  A. Seat Height                  B. Seat Depth                  C. Back Height                  D. Overall Height                  E. Overall Depth                  F. Overall Width</p>	<p>A. 16"                  B. 23.5"                  C. 12"                  D. 28"                  E. 33.75"                  F. 66.875"</p> 				<p><b>Arms</b>                  Metrum offers two categories of arms – end arms that can only be added to the outside ends of a unit, and mid-arms that can be added between units in a continuous layout.</p> <p><b>Configuration</b>                  While Metrum offers traditional stand-alone units (single seat, double seat, and triple seat), it is at the same time fundamentally flexible. The modular armless seats, corners, arms, and tables have all been designed to encourage creation of a wide variety of set-ups. Units next to each other in a continuous layout share a mid-leg that supports both units. To ensure clarity when ordering modular set-ups, it is critical that line items should be listed in the order in which they will be connected from left end (seated perspective) to right end.</p>
<p><b>Arms</b>                  A. Arm Height                  B. Arm Depth                  C. Arm Width</p>	<p><b>Cantilever</b>                  A. 13.5"                  B. 33.25"                  C. 9.125"</p> 	<p><b>Standard</b>                  A. 13"                  B. 33.75"                  C. 5.75"</p> 	<p><b>Bookshelf</b>                  A. 14"                  B. 33"                  C. 10"</p> 	<p><b>Privacy</b>                  A. 12"                  B. 33.5"                  C. 2"</p> 	<p><b>Power</b>                  Optional power receptacles are available for surface mount in tables or undermounted on the front of seat units by either the left or right leg. Power units contain 2 USB ports and a standard, grounded 3-prong electrical outlet.</p>
	<p><b>Mid Arm Wood</b>                  A. 3" above seat                  B. 22"                  C. 7.5"</p> 	<p><b>Mid Arm Upholstered</b>                  A. 4.25" above seat                  B. 22.5"                  C. 8"</p> 			<p><b>Testing</b>                  Manufactured to comply with ANSI/BIF-MA X5.4 Lounge Seating Tests.</p> <p><b>Environment</b>                  Greenguard certified.</p>

**Dimensions / Overview**

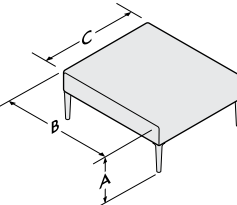
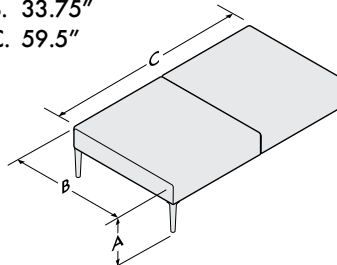
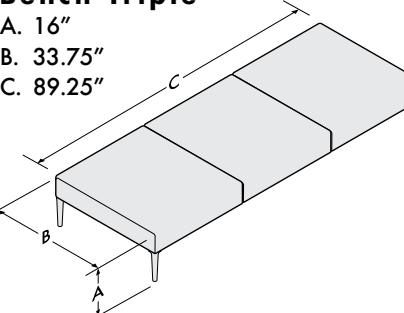
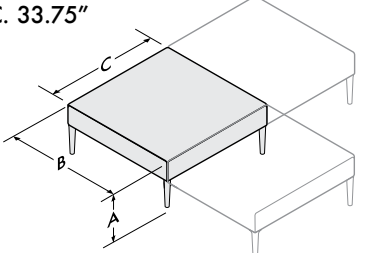
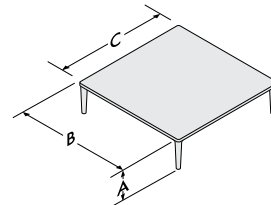
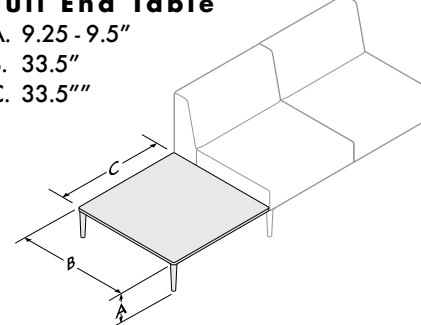
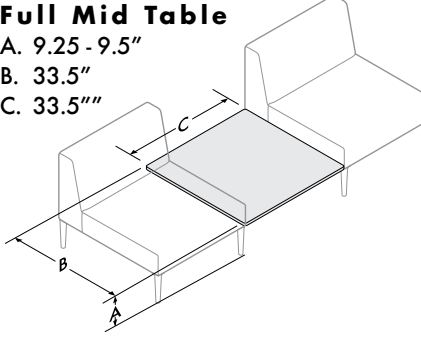
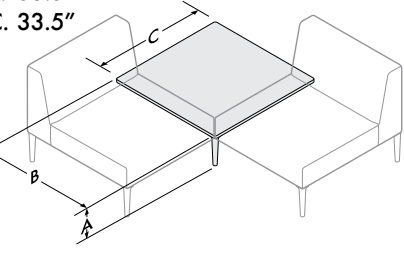
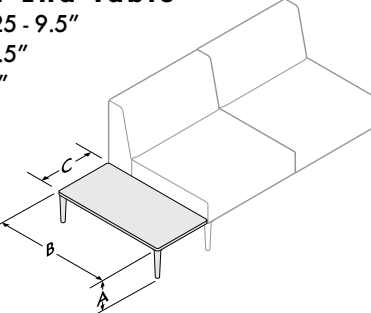
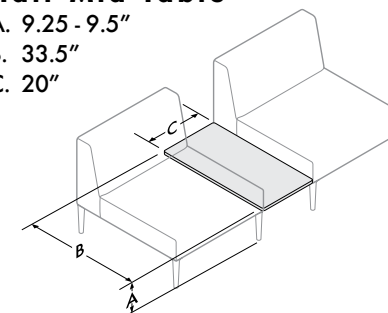
<p><b>Benches</b> A. Bench Height B. Bench Depth C. Bench Width</p>	<p><b>Bench Single</b> A. 16" B. 33.75" C. 29.75"</p> 	<p><b>Bench Double</b> A. 16" B. 33.75" C. 59.5"</p> 	<p><b>Bench Triple</b> A. 16" B. 33.75" C. 89.25"</p> 	<p><b>Bench Corner</b> A. 16" B. 33.75" C. 33.75"</p> 	<p><b>Design</b> Stylex</p> <p><b>Construction</b> Multi-density, open-cell polyurethane foam is adhered to CARB-Certified internal plywood frame. All seat and back foam surfaces are overlaid with Dacron for enhanced feel and comfort. Dymetrol® webbing is used at the foundation of all seating surfaces to provide additional, flexible support.</p> <p><b>Legs</b> Metrum is available with cast aluminum or wood legs. Cast aluminum legs may be powder coated in a variety of finishes, or ordered as polished cast aluminum. Wood legs are available in maple, white oak, and walnut. Adjustable glides are standard.</p> <p><b>Tables</b> A selection of in-stock Caesarstone, solid surface, and wood tables is available.</p> <p><b>Arms</b> Metrum offers two categories of arms - end arms that can only be added to the outside ends of a unit, and mid-arms that can be added between units in a continuous layout.</p> <p><b>Configuration</b> While Metrum offers traditional stand-alone units (single seat, double seat, and triple seat), it is at the same time fundamentally flexible. The modular armless seats, corners, arms, and tables have all been designed to encourage creation of a wide variety of set-ups. Units next to each other in a continuous layout share a mid-leg that supports both units. To ensure clarity when ordering modular set-ups, it is critical that line items should be listed in the order in which they will be connected from left end (seated perspective) to right end.</p> <p><b>Power</b> Optional power receptacles are available for surface mount in tables or undermounted on the front of seat units by either the left or right leg. Power units contain 2 USB ports and a standard, grounded 3-prong electrical outlet.</p> <p><b>Testing</b> Manufactured to comply with ANSI/BIF-MA X5.4 Lounge Seating Tests.</p> <p><b>Environment</b> Greenguard certified.</p>
<p><b>Full Tables</b> A. Height B. Depth C. Width</p>	<p><b>Full Stand-Alone Table</b> A. 9.25 - 9.5" B. 33.5" C. 33.5"</p> 	<p><b>Full End Table</b> A. 9.25 - 9.5" B. 33.5" C. 33.5"</p> 	<p><b>Full Mid Table</b> A. 9.25 - 9.5" B. 33.5" C. 33.5"</p> 	<p><b>Full Corner Table</b> A. 9.25 - 9.5" B. 33.5" C. 33.5"</p> 	
<p><b>Half Tables</b> A. Height B. Depth C. Width</p>	<p><b>Half End Table</b> A. 9.25 - 9.5" B. 33.5" C. 20"</p> 	<p><b>Half Mid Table</b> A. 9.25 - 9.5" B. 33.5" C. 20"</p> 			

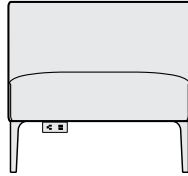
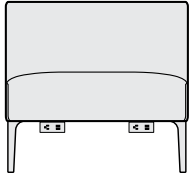
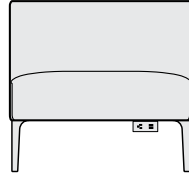
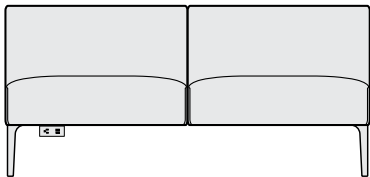
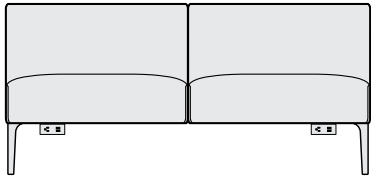
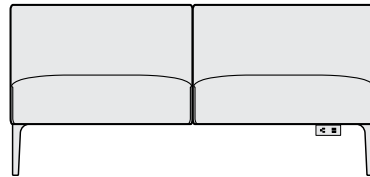
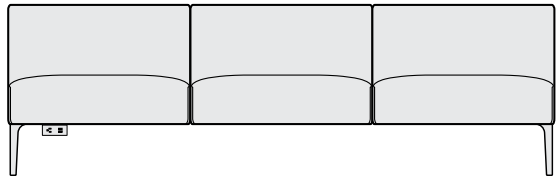
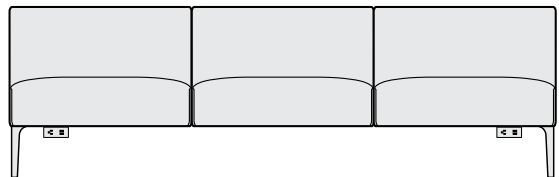
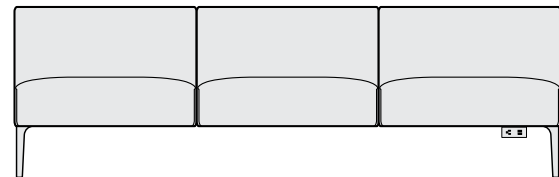
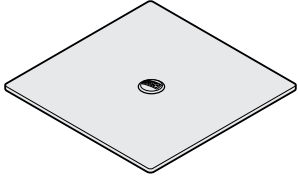
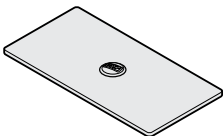
	Right Side	Double	Left Side	
<b>Single Seating Power Port Option(s)</b>				<p><b>Mounting Options</b> Table surface mount power is designated by (S) in the model code. Power mounted under seat units is designated by (U) in the model code.</p> <p><b>Cord Length</b> Table surface mount power is available with 10' or 20' cord. Power mounted under seat units has a 10' cord. 10' cord is designated by (1) and 20' cord is designated by (2).</p> <p><b>Colors</b> Power units are available in black (B), white (W), and gray (G).</p> <p><b>Location</b> Table surface mount power is centered on tables. Power mounted under seat units is located under the front edge next to the left leg (1), right leg (2), or both (3) from a seated perspective.</p> <p><b>Examples</b> S2B - Table surface, 20' cord, Black U1W2 - Under Seat, 10' cord, White, Right Side.</p> <p><b>Restrictions</b> Power is not available on corner seats or arms.</p>
<b>Double Seating Power Port Option(s)</b>				
<b>Triple Seating Power Port Option(s)</b>				
<b>Full/Half Tables Power Port Option</b>				
<b>Power Port Ordering</b>				

### Power Options Seating

### Power Options Tables



#### Power Options Seating

U1B1	Under Seat, 10' Cord, Black, Left	+450
U1B2	Under Seat, 10' Cord, Black, Right	+450
U1B3	Under Seat, 10' Cord, Black, Left & Right	+900
U1W1	Under Seat, 10' Cord, White, Left	+450
U1W2	Under Seat, 10' Cord, White, Right	+450
U1W3	Under Seat, 10' Cord, White, Left & Right	+900
U1G1	Under Seat, 10' Cord, Gray, Left	+450
U1G2	Under Seat, 10' Cord, Gray, Right	+450
U1G3	Under Seat, 10' Cord, Gray, Left & Right	+900



#### Power Options Tables

S1B	Table Surface, 10' Cord, Black	+450
S1W	Table Surface, 10' Cord, White	+450
S1G	Table Surface, 10' Cord, Gray	+450
S2B	Table Surface, 20' Cord, Black	+475
S2W	Table Surface, 20' Cord, White	+475
S2G	Table Surface, 20' Cord, Gray	+475

# Metrum

## Low-Back Single, Double and Triple with Cantilever Arms Lounge

C.O.M.  
Fabric Upholstery  
Grades

Series	Model	Description/Yds.	C.O.M.	A	B	C	D	E	F	G	H	I	J	K	L	M
MT	11B41	<b>Low-Back Single with Cantilever Arms</b>  C.O.M. yds. 3.8 Depth 33.75" Height 28" Seat Height 16" Width 48"	2,750	2,978	3,100	3,221	3,343	3,468	3,605	3,738	3,898	4,107	4,354	4,601	4,844	5,091
MT	12B41	<b>Low-Back Double with Cantilever Arms</b>  C.O.M. yds. 5.9 Depth 33.75" Height 28" Seat Height 16" Width 77.75"	4,100	4,454	4,643	4,832	5,020	5,215	5,428	5,634	5,882	6,206	6,590	6,973	7,351	7,734
MT	13B41	<b>Low-Back Triple with Cantilever Arms</b>  C.O.M. yds. 7.9 Depth 33.75" Height 28" Seat Height 16" Width 107.5"	5,300	5,774	6,027	6,280	6,532	6,793	7,078	7,354	7,686	8,120	8,634	9,147	9,653	10,166

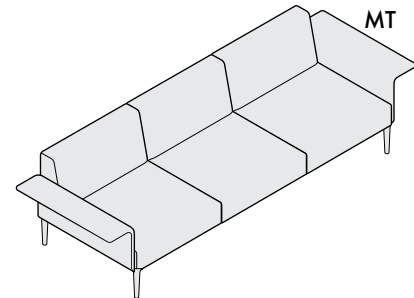
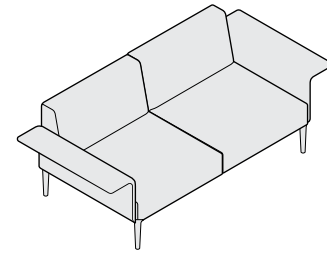
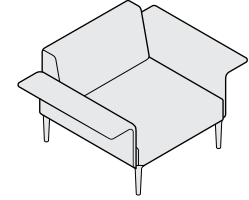

To Order follow steps 1-8

**1 Series/Section 2 Arm Choice 3 Arm Finish Choices 4 Welt Cord Options 5 Power Options 6 Leg Choice 7 Leg Finish Choices 8 Fabrics**

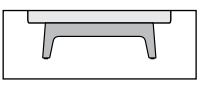
<p>MT</p> <p>11 Low-Back Single</p> <p>12 Low-Back Double</p> <p>13 Low-Back Triple</p>	<p>B41</p> <p>B41 Cantilever Arms</p> <p>Cantilever Arm</p> <p>BM Black Matte</p> <p>BT Black Twilight</p> <p>BL Blue</p> <p>CP Champagne</p> <p>DB Dark Bronze</p> <p>DC Dark Chocolate</p> <p>GR Green</p> <p>LB Light Bronze</p> <p>MF Metallic Fieldstone</p> <p>MS Metallic Silver</p> <p>MK Milk</p> <p>NK Nickel</p> <p>OR Orange</p> <p>RD Red</p> <p>ST Sterling</p> <p>TP Taupe</p> <p>TS Textured Slate</p> <p>TI Titanium</p> <p>YL Yellow</p>	<p>W3</p> <p>Welt Cord Options</p> <p>Requires an additional 0.25 yds of fabric. Not available on quilted fabric.</p> <p>Welt Cord on Seats and Backs +65 (per seat/back)</p>	<p>U1B1 Under Seat, 10' Cord, Black, Left +450</p> <p>U1B2 Under Seat, 10' Cord, Black, Right +450</p> <p>U1B3 Under Seat, 10' Cord, Black, Left &amp; Right +900</p> <p>U1W1 Under Seat, 10' Cord, White, Left +450</p> <p>U1W2 Under Seat, 10' Cord, White, Right +450</p> <p>U1W3 Under Seat, 10' Cord, White, Left &amp; Right +900</p> <p>U1G1 Under Seat, 10' Cord, Gray, Left +450</p> <p>U1G2 Under Seat, 10' Cord, Gray, Right +450</p> <p>U1G3 Under Seat, 10' Cord, Gray, Left &amp; Right +900</p>	<p>A</p> <p>W</p> <p>Cast Aluminum legs with adjustable glides.</p> <p>Wood legs with adjustable glides.</p> 	<p>AL</p> <p>Cast Aluminum - Polished</p> <p>Cast Aluminum - Standard Powder Paint</p> <p>BM Black Matte</p> <p>BT Black Twilight</p> <p>BL Blue</p> <p>CP Champagne</p> <p>DB Dark Bronze</p> <p>DC Dark Chocolate</p> <p>GR Green</p> <p>LB Light Bronze</p> <p>MF Metallic Fieldstone</p> <p>MS Metallic Silver</p> <p>MK Milk</p> <p>NK Nickel</p> <p>OR Orange</p> <p>RD Red</p> <p>ST Sterling</p> <p>TP Taupe</p> <p>TS Textured Slate</p> <p>TI Titanium</p> <p>YL Yellow</p> <p><b>Wood</b></p> <p>81 White Oak +640</p> <p>83 Natural Maple +550</p> <p>85 Walnut +720</p>	<p>Yardages provided are for non-directional fabrics that are applied railroaded. Directional fabrics may require additional yardage.</p> <p>Thick quilted fabrics will be need to be verified and may be handled as a custom order.</p> <p>Refer to Stylex swatch cards and separately published in-graded fabric program to determine grades.</p> <p>See general information section in the main price list for CAL 133 information.</p>
---	--	---	--	--	--	--

# Metrum

Low-Back Single, Double and Triple  
with Standard Upholstered Arms  
Lounge

C.O.M.  
Fabric Upholstery  
Grades

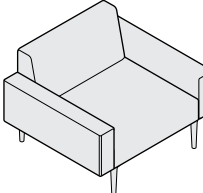
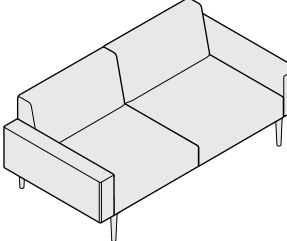
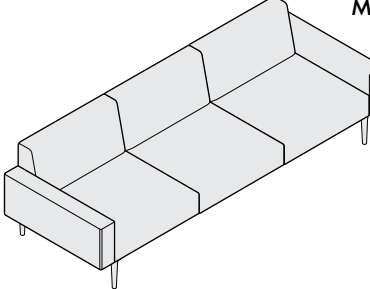
Series Model	Description/Yds.	C.O.M.	A	B	C	D	E	F	G	H	I	J	K	L	M																																																																																															
 MT 11B44 <table border="0" style="margin-left: 20px;"> <tr> <td><b>Low-Back Single with Standard Arms</b></td> <td>2,490</td> <td>2,820</td> <td>2,996</td> <td>3,172</td> <td>3,348</td> <td>3,530</td> <td>3,728</td> <td>3,920</td> <td>4,151</td> <td>4,454</td> <td>4,811</td> <td>5,169</td> <td>5,521</td> <td>5,878</td> </tr> <tr> <td>C.O.M. yds.</td> <td colspan="15">5.5</td> </tr> <tr> <td>Depth</td> <td colspan="15">33.75"</td> </tr> <tr> <td>Height</td> <td colspan="15">28"</td> </tr> <tr> <td>Seat Height</td> <td colspan="15">16"</td> </tr> <tr> <td>Width</td> <td colspan="15">41.25"</td> </tr> </table>	<b>Low-Back Single with Standard Arms</b>	2,490	2,820	2,996	3,172	3,348	3,530	3,728	3,920	4,151	4,454	4,811	5,169	5,521	5,878	C.O.M. yds.	5.5															Depth	33.75"															Height	28"															Seat Height	16"															Width	41.25"																													
<b>Low-Back Single with Standard Arms</b>	2,490	2,820	2,996	3,172	3,348	3,530	3,728	3,920	4,151	4,454	4,811	5,169	5,521	5,878																																																																																																
C.O.M. yds.	5.5																																																																																																													
Depth	33.75"																																																																																																													
Height	28"																																																																																																													
Seat Height	16"																																																																																																													
Width	41.25"																																																																																																													
 MT 12B44 <table border="0" style="margin-left: 20px;"> <tr> <td><b>Low-Back Double with Standard Arms</b></td> <td>3,840</td> <td>4,296</td> <td>4,539</td> <td>4,782</td> <td>5,026</td> <td>5,276</td> <td>5,550</td> <td>5,816</td> <td>6,135</td> <td>6,553</td> <td>7,047</td> <td>7,541</td> <td>8,028</td> <td>8,522</td> </tr> <tr> <td>C.O.M. yds.</td> <td colspan="15">7.6</td> </tr> <tr> <td>Depth</td> <td colspan="15">33.75"</td> </tr> <tr> <td>Height</td> <td colspan="15">28"</td> </tr> <tr> <td>Seat Height</td> <td colspan="15">16"</td> </tr> <tr> <td>Width</td> <td colspan="15">71"</td> </tr> </table>	<b>Low-Back Double with Standard Arms</b>	3,840	4,296	4,539	4,782	5,026	5,276	5,550	5,816	6,135	6,553	7,047	7,541	8,028	8,522	C.O.M. yds.	7.6															Depth	33.75"															Height	28"															Seat Height	16"															Width	71"																													
<b>Low-Back Double with Standard Arms</b>	3,840	4,296	4,539	4,782	5,026	5,276	5,550	5,816	6,135	6,553	7,047	7,541	8,028	8,522																																																																																																
C.O.M. yds.	7.6																																																																																																													
Depth	33.75"																																																																																																													
Height	28"																																																																																																													
Seat Height	16"																																																																																																													
Width	71"																																																																																																													
 MT 13B44 <table border="0" style="margin-left: 20px;"> <tr> <td><b>Low-Back Triple with Standard Arms</b></td> <td>5,040</td> <td>5,616</td> <td>5,923</td> <td>6,230</td> <td>6,538</td> <td>6,854</td> <td>7,200</td> <td>7,536</td> <td>7,939</td> <td>8,467</td> <td>9,091</td> <td>9,715</td> <td>10,330</td> <td>10,954</td> </tr> <tr> <td>C.O.M. yds.</td> <td colspan="15">9.6</td> </tr> <tr> <td>Depth</td> <td colspan="15">33.75"</td> </tr> <tr> <td>Height</td> <td colspan="15">28"</td> </tr> <tr> <td>Seat Height</td> <td colspan="15">16"</td> </tr> <tr> <td>Width</td> <td colspan="15">100.75"</td> </tr> </table>	<b>Low-Back Triple with Standard Arms</b>	5,040	5,616	5,923	6,230	6,538	6,854	7,200	7,536	7,939	8,467	9,091	9,715	10,330	10,954	C.O.M. yds.	9.6															Depth	33.75"															Height	28"															Seat Height	16"															Width	100.75"																													
<b>Low-Back Triple with Standard Arms</b>	5,040	5,616	5,923	6,230	6,538	6,854	7,200	7,536	7,939	8,467	9,091	9,715	10,330	10,954																																																																																																
C.O.M. yds.	9.6																																																																																																													
Depth	33.75"																																																																																																													
Height	28"																																																																																																													
Seat Height	16"																																																																																																													
Width	100.75"																																																																																																													

To Order follow steps 1-7

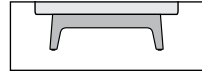
1 Series/Section	2 Arm Choice	3 Welt Cord Options	4 Power Options	5 Leg Choice	6 Leg Finish Choices	7 Fabrics																				
<p>MT</p> <ul style="list-style-type: none"> <li>11 Low-Back Single</li> <li>12 Low-Back Double</li> <li>13 Low-Back Triple</li> </ul>	<p>B44</p> <ul style="list-style-type: none"> <li>B44 Standard Upholstered Arms</li> </ul>	<ul style="list-style-type: none"> <li>W3 Welt Cord on Seats and Backs +65 (per seat/back)</li> <li>W5 Welt Cord on Seats, Backs &amp; Arms +100 (arms) +65 (per seat/back)</li> </ul>	<ul style="list-style-type: none"> <li>U1B1 Under Seat, 10' Cord, Black, Left +450</li> <li>U1B2 Under Seat, 10' Cord, Black, Right +450</li> <li>U1B3 Under Seat, 10' Cord, Black, Left &amp; Right +900</li> <li>U1W1 Under Seat, 10' Cord, White, Left +450</li> <li>U1W2 Under Seat, 10' Cord, White, Right +450</li> <li>U1W3 Under Seat, 10' Cord, White, Left &amp; Right +900</li> <li>U1G1 Under Seat, 10' Cord, Gray, Left +450</li> <li>U1G2 Under Seat, 10' Cord, Gray, Right +450</li> <li>U1G3 Under Seat, 10' Cord, Gray, Left &amp; Right +900</li> </ul>	<ul style="list-style-type: none"> <li>A Cast Aluminum legs with adjustable glides.</li> <li>W Wood legs with adjustable glides.</li> </ul> 	<ul style="list-style-type: none"> <li>AL Cast Aluminum - Polished</li> <li>AL Cast Aluminum - Standard Powder Paint</li> </ul> <table border="0" style="width: 100%; font-size: small;"> <tr> <td>BM Black Matte</td> <td>MK Milk</td> </tr> <tr> <td>BT Black Twilight</td> <td>NK Nickel</td> </tr> <tr> <td>BL Blue</td> <td>OR Orange</td> </tr> <tr> <td>CP Champagne</td> <td>RD Red</td> </tr> <tr> <td>DB Dark Bronze</td> <td>ST Sterling</td> </tr> <tr> <td>DC Dark Chocolate</td> <td>TP Taupe</td> </tr> <tr> <td>GR Green</td> <td>TS Textured Slate</td> </tr> <tr> <td>LB Light Bronze</td> <td>TI Titanium</td> </tr> <tr> <td>MF Metallic Fieldstone</td> <td>YL Yellow</td> </tr> <tr> <td>MS Metallic Silver</td> <td></td> </tr> </table> <ul style="list-style-type: none"> <li>Wood</li> <li>81 White Oak +640</li> <li>83 Natural Maple +550</li> <li>85 Walnut +720</li> </ul>	BM Black Matte	MK Milk	BT Black Twilight	NK Nickel	BL Blue	OR Orange	CP Champagne	RD Red	DB Dark Bronze	ST Sterling	DC Dark Chocolate	TP Taupe	GR Green	TS Textured Slate	LB Light Bronze	TI Titanium	MF Metallic Fieldstone	YL Yellow	MS Metallic Silver		<ul style="list-style-type: none"> <li>Yardages provided are for non-directional fabrics that are applied railroaded. Directional fabrics may require additional yardage.</li> <li>Thick quilted fabrics will be need to be verified and may be handled as a custom order.</li> <li>Refer to Stylex swatch cards and separately published in-graded fabric program to determine grades.</li> <li>See general information section in the main price list for CAL 133 information.</li> </ul>
BM Black Matte	MK Milk																									
BT Black Twilight	NK Nickel																									
BL Blue	OR Orange																									
CP Champagne	RD Red																									
DB Dark Bronze	ST Sterling																									
DC Dark Chocolate	TP Taupe																									
GR Green	TS Textured Slate																									
LB Light Bronze	TI Titanium																									
MF Metallic Fieldstone	YL Yellow																									
MS Metallic Silver																										



# Metrum

## High-Back Single, Double and Triple with Privacy Arms Lounge

C.O.M.  
Fabric Upholstery  
Grades

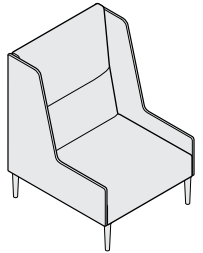
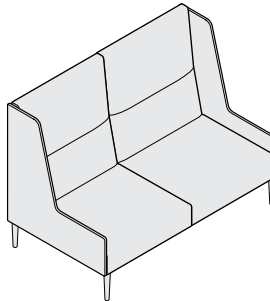
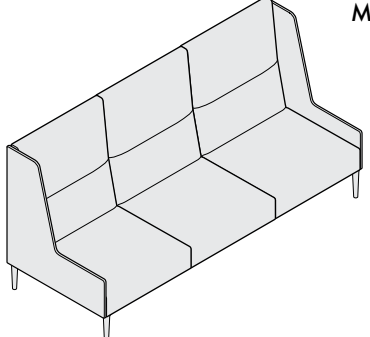
Series Model	Description/Yds.	C.O.M.	A	B	C	D	E	F	G	H	I	J	K	L	M
	MT 21B43 <b>High-Back Single with Privacy Arms</b>	2,800	3,196	3,407	3,618	3,830	4,047	4,285	4,516	4,793	5,156	5,585	6,014	6,437	6,866
	C.O.M. yds.	6.6													
	Depth	33.75"													
	Height	44.5"													
	Seat Height	16"													
	MT 22B43 <b>High-Back Double with Privacy Arms</b>	4,400	4,970	5,274	5,578	5,882	6,196	6,538	6,870	7,269	7,792	8,409	9,027	9,635	10,252
	C.O.M. yds.	9.5													
	Depth	33.75"													
	Height	44.5"													
	Seat Height	16"													
	MT 23B43 <b>High-Back Triple with Privacy Arms</b>	5,900	6,638	7,032	7,425	7,819	8,225	8,668	9,098	9,615	10,291	11,091	11,890	12,677	13,477
	C.O.M. yds.	12.3													
	Depth	33.75"													
	Height	44.5"													
	Seat Height	16"													

To Order follow steps 1-7

**1 Series/Section    2 Arm Choice    3 Welt Cord Options    4 Power Options    5 Leg Choice    6 Leg Finish Choices    7 Fabrics**

MT

- 21 High-Back Single
- 22 High-Back Double
- 23 High-Back Triple

B43

B43 Privacy Arms

● **Welt Cord Options**  
Requires an additional 0.25 yds of fabric. (0.5 yds for High-Back Triple) Not available on quilted fabric.

W3 Welt Cord on Seats and Backs +70 (per seat/back)

● **Power Options**

- U1B1 Under Seat, 10' Cord, Black, Left +450
- U1B2 Under Seat, 10' Cord, Black, Right +450
- U1B3 Under Seat, 10' Cord, Black, Left & Right +900
- U1W1 Under Seat, 10' Cord, White, Left +450
- U1W2 Under Seat, 10' Cord, White, Right +450
- U1W3 Under Seat, 10' Cord, White, Left & Right +900
- U1G1 Under Seat, 10' Cord, Gray, Left +450
- U1G2 Under Seat, 10' Cord, Gray, Right +450
- U1G3 Under Seat, 10' Cord, Gray, Left & Right +900

● **A** Cast Aluminum legs with adjustable glides.

● **W** Wood legs with adjustable glides.

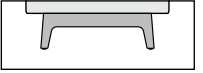

● **AL** **Cast Aluminum - Polished**

● **Cast Aluminum - Standard Powder Paint**

BM Black Matte	MK Milk
BT Black Twilight	NK Nickel
BL Blue	OR Orange
CP Champagne	RD Red
DB Dark Bronze	ST Sterling
DC Dark Chocolate	TP Taupe
GR Green	TS Textured Slate
LB Light Bronze	TI Titanium
MF Metallic Fieldstone	YL Yellow
MS Metallic Silver	

● **Wood**

81 White Oak	+640
83 Natural Maple	+550
85 Walnut	+720

● Yardages provided are for non-directional fabrics that are applied railroaded. Directional fabrics may require additional yardage.

Thick quilted fabrics will be need to be verified and may be handled as a custom order.

Refer to Stylex swatch cards and separately published in-graded fabric program to determine grades.

See general information section in the main price list for CAL 133 information.

# Metrum

## Low-Back Single, Double and Triple Armless Lounge

C.O.M.  
Fabric Upholstery  
Grades

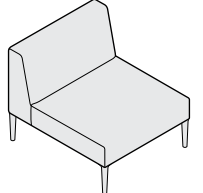
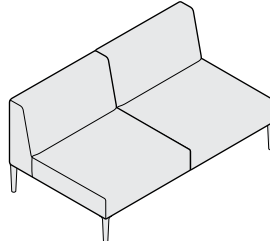
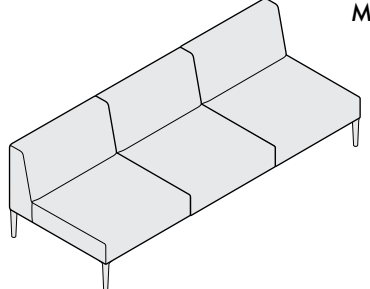
Series	Model	Description/Yds.	C.O.M.	A	B	C	D	E	F	G	H	I	J	K	L	M
	MT 11	<b>Low-Back Single</b>	1,750	1,912	1,998	2,085	2,171	2,260	2,358	2,452	2,565	2,714	2,889	3,065	3,238	3,413
		C.O.M. yds. 2.7 Depth 33.75" Height 28" Seat Height 16" Width 29.75"														
	MT 12	<b>Low-Back Double</b>	3,100	3,388	3,542	3,695	3,849	4,007	4,180	4,348	4,550	4,814	5,126	5,438	5,745	6,057
		C.O.M. yds. 4.8 Depth 33.75" Height 28" Seat Height 16" Width 59.5"														
	MT 13	<b>Low-Back Triple</b>	4,300	4,708	4,926	5,143	5,361	5,585	5,830	6,068	6,354	6,728	7,170	7,612	8,047	8,489
		C.O.M. yds. 6.8 Depth 33.75" Height 28" Seat Height 16" Width 89.25"														

To Order follow steps 1-7

**1 Series/Section    2 Welt Cord Options    3 Upholstery Options    4 Power Options    5 Leg Choice    6 Leg Finish Choices    7 Fabrics**

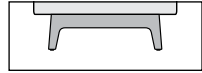
<p>MT</p> <p>11 Low-Back Single</p> <p>12 Low-Back Double</p> <p>13 Low-Back Triple</p>	<p>W3 Welt Cord on Seats and Backs +65 (per seat/back)</p>	<p>DF Dual Fabric</p> <p>The Dual Fabric Option allows for a second fabric to be applied to the seats. When specifying In-Graded fabrics, please apply the higher of the two grades.</p> <table border="0"> <tr> <td>Low-Back Single</td> <td>Fabric 1 Seat</td> <td>1.6 yds.</td> </tr> <tr> <td></td> <td>Fabric 2 Back</td> <td>1.5 yds.</td> </tr> <tr> <td>Low-Back Double</td> <td>Fabric 1 Seats</td> <td>2.6 yds.</td> </tr> <tr> <td></td> <td>Fabric 2 Backs</td> <td>2.2 yds.</td> </tr> <tr> <td>Low-Back Triple</td> <td>Fabric 1 Seats</td> <td>3.6 yds.</td> </tr> <tr> <td></td> <td>Fabric 2 Backs</td> <td>3.3 yds.</td> </tr> </table>	Low-Back Single	Fabric 1 Seat	1.6 yds.		Fabric 2 Back	1.5 yds.	Low-Back Double	Fabric 1 Seats	2.6 yds.		Fabric 2 Backs	2.2 yds.	Low-Back Triple	Fabric 1 Seats	3.6 yds.		Fabric 2 Backs	3.3 yds.	<p>Power Options</p> <table border="0"> <tr> <td>U1B1 Under Seat, 10' Cord, Black, Left</td> <td>+450</td> </tr> <tr> <td>U1B2 Under Seat, 10' Cord, Black, Right</td> <td>+450</td> </tr> <tr> <td>U1B3 Under Seat, 10' Cord, Black, Left &amp; Right</td> <td>+900</td> </tr> <tr> <td>U1W1 Under Seat, 10' Cord, White, Left</td> <td>+450</td> </tr> <tr> <td>U1W2 Under Seat, 10' Cord, White, Right</td> <td>+450</td> </tr> <tr> <td>U1W3 Under Seat, 10' Cord, White, Left &amp; Right</td> <td>+900</td> </tr> <tr> <td>U1G1 Under Seat, 10' Cord, Gray, Left</td> <td>+450</td> </tr> <tr> <td>U1G2 Under Seat, 10' Cord, Gray, Right</td> <td>+450</td> </tr> <tr> <td>U1G3 Under Seat, 10' Cord, Gray, Left &amp; Right</td> <td>+900</td> </tr> </table>	U1B1 Under Seat, 10' Cord, Black, Left	+450	U1B2 Under Seat, 10' Cord, Black, Right	+450	U1B3 Under Seat, 10' Cord, Black, Left & Right	+900	U1W1 Under Seat, 10' Cord, White, Left	+450	U1W2 Under Seat, 10' Cord, White, Right	+450	U1W3 Under Seat, 10' Cord, White, Left & Right	+900	U1G1 Under Seat, 10' Cord, Gray, Left	+450	U1G2 Under Seat, 10' Cord, Gray, Right	+450	U1G3 Under Seat, 10' Cord, Gray, Left & Right	+900	<p>A Cast Aluminum legs with adjustable glides.</p> <p>W Wood legs with adjustable glides.</p> 	<p>AL Cast Aluminum - Polished</p> <p>Cast Aluminum - Standard Powder Paint</p> <table border="0"> <tr> <td>BM Black Matte</td> <td>MK Milk</td> </tr> <tr> <td>BT Black Twilight</td> <td>NK Nickel</td> </tr> <tr> <td>BL Blue</td> <td>OR Orange</td> </tr> <tr> <td>CP Champagne</td> <td>RD Red</td> </tr> <tr> <td>DB Dark Bronze</td> <td>ST Sterling</td> </tr> <tr> <td>DC Dark Chocolate</td> <td>TP Taupe</td> </tr> <tr> <td>GR Green</td> <td>TS Textured Slate</td> </tr> <tr> <td>LB Light Bronze</td> <td>TI Titanium</td> </tr> <tr> <td>MF Metallic Fieldstone</td> <td>YL Yellow</td> </tr> <tr> <td>MS Metallic Silver</td> <td></td> </tr> </table> <p>Wood</p> <table border="0"> <tr> <td>81 White Oak</td> <td>+640</td> </tr> <tr> <td>83 Natural Maple</td> <td>+550</td> </tr> <tr> <td>85 Walnut</td> <td>+720</td> </tr> </table>	BM Black Matte	MK Milk	BT Black Twilight	NK Nickel	BL Blue	OR Orange	CP Champagne	RD Red	DB Dark Bronze	ST Sterling	DC Dark Chocolate	TP Taupe	GR Green	TS Textured Slate	LB Light Bronze	TI Titanium	MF Metallic Fieldstone	YL Yellow	MS Metallic Silver		81 White Oak	+640	83 Natural Maple	+550	85 Walnut	+720	<p>Yardages provided are for non-directional fabrics that are applied railroaded. Directional fabrics may require additional yardage.</p> <p>Thick quilted fabrics will be need to be verified and may be handled as a custom order.</p> <p>Refer to Stylex swatch cards and separately published in-graded fabric program to determine grades.</p> <p>See general information section in the main price list for CAL 133 information.</p>
Low-Back Single	Fabric 1 Seat	1.6 yds.																																																																		
	Fabric 2 Back	1.5 yds.																																																																		
Low-Back Double	Fabric 1 Seats	2.6 yds.																																																																		
	Fabric 2 Backs	2.2 yds.																																																																		
Low-Back Triple	Fabric 1 Seats	3.6 yds.																																																																		
	Fabric 2 Backs	3.3 yds.																																																																		
U1B1 Under Seat, 10' Cord, Black, Left	+450																																																																			
U1B2 Under Seat, 10' Cord, Black, Right	+450																																																																			
U1B3 Under Seat, 10' Cord, Black, Left & Right	+900																																																																			
U1W1 Under Seat, 10' Cord, White, Left	+450																																																																			
U1W2 Under Seat, 10' Cord, White, Right	+450																																																																			
U1W3 Under Seat, 10' Cord, White, Left & Right	+900																																																																			
U1G1 Under Seat, 10' Cord, Gray, Left	+450																																																																			
U1G2 Under Seat, 10' Cord, Gray, Right	+450																																																																			
U1G3 Under Seat, 10' Cord, Gray, Left & Right	+900																																																																			
BM Black Matte	MK Milk																																																																			
BT Black Twilight	NK Nickel																																																																			
BL Blue	OR Orange																																																																			
CP Champagne	RD Red																																																																			
DB Dark Bronze	ST Sterling																																																																			
DC Dark Chocolate	TP Taupe																																																																			
GR Green	TS Textured Slate																																																																			
LB Light Bronze	TI Titanium																																																																			
MF Metallic Fieldstone	YL Yellow																																																																			
MS Metallic Silver																																																																				
81 White Oak	+640																																																																			
83 Natural Maple	+550																																																																			
85 Walnut	+720																																																																			

# Metrum

## High-Back Single, Double and Triple Armless Lounge

C.O.M.  
Fabric Upholstery  
Grades

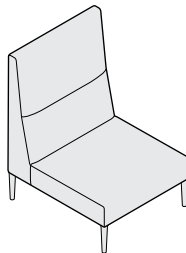
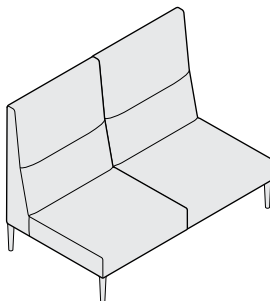
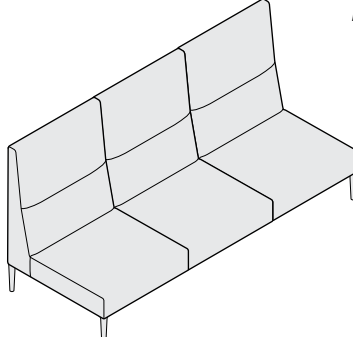
Series	Model	Description/Yds.	C.O.M.	A	B	C	D	E	F	G	H	I	J	K	L	M		
	MT	21	<b>High-Back Single</b>	2,200	2,398	2,504	2,609	2,715	2,824	2,943	3,058	3,197	3,378	3,593	3,807	4,018	4,233	
			C.O.M. yds.	3.3														
			Depth	33.75"														
			Height	44.5"														
	MT	22	<b>High-Back Double</b>	3,800	4,172	4,370	4,569	4,767	4,972	5,195	5,412	5,672	6,013	6,416	6,819	7,216	7,619	
			C.O.M. yds.	6.2														
			Depth	33.75"														
			Height	44.5"														
	MT	23	<b>High-Back Triple</b>	5,300	5,840	6,128	6,416	6,704	7,001	7,325	7,640	8,018	8,513	9,098	9,683	10,259	10,844	
			C.O.M. yds.	9.0														
			Depth	33.75"														
			Height	44.5"														

To Order follow steps 1-7

**1 Series/Section    2 Welt Cord Options    3 Upholstery Options    4 Power Options    5 Leg Choice    6 Leg Finish Choices    7 Fabrics**

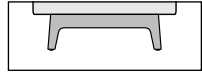
<p>MT</p> <p>21 High-Back Single</p> <p>22 High-Back Double</p> <p>23 High-Back Triple</p>	<p>W3 Welt Cord on Seats and Backs +70 (per seat/back)</p>	<p>DF Dual Fabric</p> <p>The Dual Fabric Option allows for a second fabric to be applied to the seats. When specifying In-Graded fabrics, please apply the higher of the two grades.</p> <table border="0"> <tr> <td>High-Back Single</td> <td>Fabric 1</td> <td>Seat</td> <td>1.6 yds.</td> </tr> <tr> <td></td> <td>Fabric 2</td> <td>Back</td> <td>2.5 yds.</td> </tr> <tr> <td>High-Back Double</td> <td>Fabric 1</td> <td>Seats</td> <td>2.7 yds.</td> </tr> <tr> <td></td> <td>Fabric 2</td> <td>Backs</td> <td>4.3 yds.</td> </tr> <tr> <td>High-Back Triple</td> <td>Fabric 1</td> <td>Seats</td> <td>3.0 yds.</td> </tr> <tr> <td></td> <td>Fabric 2</td> <td>Backs</td> <td>6.2 yds.</td> </tr> </table>	High-Back Single	Fabric 1	Seat	1.6 yds.		Fabric 2	Back	2.5 yds.	High-Back Double	Fabric 1	Seats	2.7 yds.		Fabric 2	Backs	4.3 yds.	High-Back Triple	Fabric 1	Seats	3.0 yds.		Fabric 2	Backs	6.2 yds.	<p>Power Options</p> <table border="0"> <tr> <td>U1B1</td> <td>Under Seat, 10' Cord, Black, Left</td> <td>+450</td> </tr> <tr> <td>U1B2</td> <td>Under Seat, 10' Cord, Black, Right</td> <td>+450</td> </tr> <tr> <td>U1B3</td> <td>Under Seat, 10' Cord, Black, Left &amp; Right</td> <td>+900</td> </tr> <tr> <td>U1W1</td> <td>Under Seat, 10' Cord, White, Left</td> <td>+450</td> </tr> <tr> <td>U1W2</td> <td>Under Seat, 10' Cord, White, Right</td> <td>+450</td> </tr> <tr> <td>U1W3</td> <td>Under Seat, 10' Cord, White, Left &amp; Right</td> <td>+900</td> </tr> <tr> <td>U1G1</td> <td>Under Seat, 10' Cord, Gray, Left</td> <td>+450</td> </tr> <tr> <td>U1G2</td> <td>Under Seat, 10' Cord, Gray, Right</td> <td>+450</td> </tr> <tr> <td>U1G3</td> <td>Under Seat, 10' Cord, Gray, Left &amp; Right</td> <td>+900</td> </tr> </table>	U1B1	Under Seat, 10' Cord, Black, Left	+450	U1B2	Under Seat, 10' Cord, Black, Right	+450	U1B3	Under Seat, 10' Cord, Black, Left & Right	+900	U1W1	Under Seat, 10' Cord, White, Left	+450	U1W2	Under Seat, 10' Cord, White, Right	+450	U1W3	Under Seat, 10' Cord, White, Left & Right	+900	U1G1	Under Seat, 10' Cord, Gray, Left	+450	U1G2	Under Seat, 10' Cord, Gray, Right	+450	U1G3	Under Seat, 10' Cord, Gray, Left & Right	+900	<p>A Cast Aluminum legs with adjustable glides.</p> <p>W Wood legs with adjustable glides.</p> 	<p>AL Cast Aluminum - Polished</p> <p>Cast Aluminum - Standard Powder Paint</p> <table border="0"> <tr> <td>BM</td> <td>Black Matte</td> <td>MK</td> <td>Milk</td> </tr> <tr> <td>BT</td> <td>Black Twilight</td> <td>NK</td> <td>Nickel</td> </tr> <tr> <td>BL</td> <td>Blue</td> <td>OR</td> <td>Orange</td> </tr> <tr> <td>CP</td> <td>Champagne</td> <td>RD</td> <td>Red</td> </tr> <tr> <td>DB</td> <td>Dark Bronze</td> <td>ST</td> <td>Sterling</td> </tr> <tr> <td>DC</td> <td>Dark Chocolate</td> <td>TP</td> <td>Taupe</td> </tr> <tr> <td>GR</td> <td>Green</td> <td>TS</td> <td>Textured Slate</td> </tr> <tr> <td>LB</td> <td>Light Bronze</td> <td>TI</td> <td>Titanium</td> </tr> <tr> <td>MF</td> <td>Metallic Fieldstone</td> <td>YL</td> <td>Yellow</td> </tr> <tr> <td>MS</td> <td>Metallic Silver</td> <td></td> <td></td> </tr> </table> <p>Wood</p> <table border="0"> <tr> <td>81</td> <td>White Oak</td> <td>+640</td> </tr> <tr> <td>83</td> <td>Natural Maple</td> <td>+550</td> </tr> <tr> <td>85</td> <td>Walnut</td> <td>+720</td> </tr> </table>	BM	Black Matte	MK	Milk	BT	Black Twilight	NK	Nickel	BL	Blue	OR	Orange	CP	Champagne	RD	Red	DB	Dark Bronze	ST	Sterling	DC	Dark Chocolate	TP	Taupe	GR	Green	TS	Textured Slate	LB	Light Bronze	TI	Titanium	MF	Metallic Fieldstone	YL	Yellow	MS	Metallic Silver			81	White Oak	+640	83	Natural Maple	+550	85	Walnut	+720	<p>Yardages provided are for non-directional fabrics that are applied railroaded. Directional fabrics may require additional yardage.</p> <p>Thick quilted fabrics will be need to be verified and may be handled as a custom order.</p> <p>Refer to Stylex swatch cards and separately published in-graded fabric program to determine grades.</p> <p>See general information section in the main price list for CAL 133 information.</p>
High-Back Single	Fabric 1	Seat	1.6 yds.																																																																																																							
	Fabric 2	Back	2.5 yds.																																																																																																							
High-Back Double	Fabric 1	Seats	2.7 yds.																																																																																																							
	Fabric 2	Backs	4.3 yds.																																																																																																							
High-Back Triple	Fabric 1	Seats	3.0 yds.																																																																																																							
	Fabric 2	Backs	6.2 yds.																																																																																																							
U1B1	Under Seat, 10' Cord, Black, Left	+450																																																																																																								
U1B2	Under Seat, 10' Cord, Black, Right	+450																																																																																																								
U1B3	Under Seat, 10' Cord, Black, Left & Right	+900																																																																																																								
U1W1	Under Seat, 10' Cord, White, Left	+450																																																																																																								
U1W2	Under Seat, 10' Cord, White, Right	+450																																																																																																								
U1W3	Under Seat, 10' Cord, White, Left & Right	+900																																																																																																								
U1G1	Under Seat, 10' Cord, Gray, Left	+450																																																																																																								
U1G2	Under Seat, 10' Cord, Gray, Right	+450																																																																																																								
U1G3	Under Seat, 10' Cord, Gray, Left & Right	+900																																																																																																								
BM	Black Matte	MK	Milk																																																																																																							
BT	Black Twilight	NK	Nickel																																																																																																							
BL	Blue	OR	Orange																																																																																																							
CP	Champagne	RD	Red																																																																																																							
DB	Dark Bronze	ST	Sterling																																																																																																							
DC	Dark Chocolate	TP	Taupe																																																																																																							
GR	Green	TS	Textured Slate																																																																																																							
LB	Light Bronze	TI	Titanium																																																																																																							
MF	Metallic Fieldstone	YL	Yellow																																																																																																							
MS	Metallic Silver																																																																																																									
81	White Oak	+640																																																																																																								
83	Natural Maple	+550																																																																																																								
85	Walnut	+720																																																																																																								

# Metrum

## Low-Back Corner, Chaise and High-Back Corner Lounge

C.O.M.  
Fabric Upholstery  
Grades

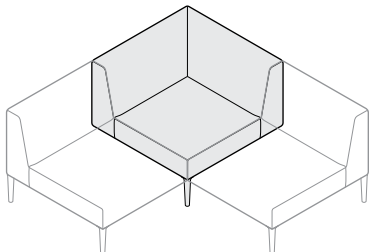
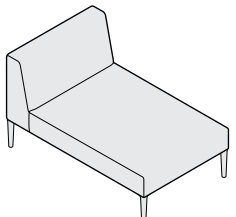
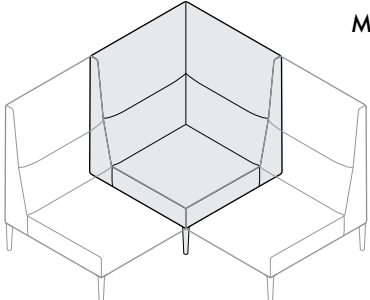
Series	Model	Description/Yds.	C.O.M.	A	B	C	D	E	F	G	H	I	J	K	L	M
	MT 14	<b>Low-Back Corner</b>	2,500	2,716	2,831	2,946	3,062	3,180	3,310	3,436	3,587	3,785	4,019	4,253	4,484	4,718
		C.O.M. yds. 3.6 Depth 33.5" Height 28" Seat Height 16" Width 33.5"														
	MT 15	<b>Low-Back Chaise</b>	2,050	2,248	2,354	2,459	2,565	2,674	2,793	2,908	3,047	3,228	3,443	3,657	3,868	4,083
		C.O.M. yds. 3.3 Depth 48.75" Height 28" Seat Height 16" Width 29.75"														
	MT 24	<b>High-Back Corner</b>	3,400	3,712	3,878	4,045	4,211	4,383	4,570	4,752	4,970	5,256	5,594	5,932	6,265	6,603
		C.O.M. yds. 5.2 Depth 33.5" Height 44.5" Seat Height 16" Width 33.5"														

To Order follow steps 1-7

### 1 Series/Section 2 Welt Cord Options 3 Upholstery Options 4 Power Options 5 Leg Choice 6 Leg Finish Choices 7 Fabrics

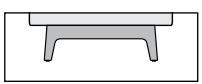
<p><b>MT</b></p> <ul style="list-style-type: none"> <li>14 Low-Back Corner</li> <li>15 Low-Back Chaise</li> <li>24 High-Back Corner</li> </ul>	<p><b>W3</b> Welt Cord on Seat and Back +95</p>	<p><b>DF</b> <b>Dual Fabric</b> The Dual Fabric Option allows for a second fabric to be applied to the seats. When specifying In-Graded fabrics, please apply the higher of the two grades.</p> <table border="0"> <tr> <td>Low-Back Corner</td> <td>Fabric 1 Seat</td> <td>1.6 yds.</td> </tr> <tr> <td></td> <td>Fabric 2 Back</td> <td>2.4 yds.</td> </tr> <tr> <td>Low-Back Chaise</td> <td>Fabric 1 Seat</td> <td>2.4 yds.</td> </tr> <tr> <td></td> <td>Fabric 2 Back</td> <td>1.5 yds.</td> </tr> <tr> <td>High-Back Corner</td> <td>Fabric 1 Seat</td> <td>1.6 yds.</td> </tr> <tr> <td></td> <td>Fabric 2 Back</td> <td>4.3 yds.</td> </tr> </table>	Low-Back Corner	Fabric 1 Seat	1.6 yds.		Fabric 2 Back	2.4 yds.	Low-Back Chaise	Fabric 1 Seat	2.4 yds.		Fabric 2 Back	1.5 yds.	High-Back Corner	Fabric 1 Seat	1.6 yds.		Fabric 2 Back	4.3 yds.	<p><b>Power Options available on Chaise only</b></p> <table border="0"> <tr> <td>U1B1 Under Seat, 10' Cord, Black, Left</td> <td>+450</td> </tr> <tr> <td>U1B2 Under Seat, 10' Cord, Black, Right</td> <td>+450</td> </tr> <tr> <td>U1B3 Under Seat, 10' Cord, Black, Left &amp; Right</td> <td>+900</td> </tr> <tr> <td>U1W1 Under Seat, 10' Cord, White, Left</td> <td>+450</td> </tr> <tr> <td>U1W2 Under Seat, 10' Cord, White, Right</td> <td>+450</td> </tr> <tr> <td>U1W3 Under Seat, 10' Cord, White, Left &amp; Right</td> <td>+900</td> </tr> <tr> <td>U1G1 Under Seat, 10' Cord, Gray, Left</td> <td>+450</td> </tr> <tr> <td>U1G2 Under Seat, 10' Cord, Gray, Right</td> <td>+450</td> </tr> <tr> <td>U1G3 Under Seat, 10' Cord, Gray, Left &amp; Right</td> <td>+900</td> </tr> </table>	U1B1 Under Seat, 10' Cord, Black, Left	+450	U1B2 Under Seat, 10' Cord, Black, Right	+450	U1B3 Under Seat, 10' Cord, Black, Left & Right	+900	U1W1 Under Seat, 10' Cord, White, Left	+450	U1W2 Under Seat, 10' Cord, White, Right	+450	U1W3 Under Seat, 10' Cord, White, Left & Right	+900	U1G1 Under Seat, 10' Cord, Gray, Left	+450	U1G2 Under Seat, 10' Cord, Gray, Right	+450	U1G3 Under Seat, 10' Cord, Gray, Left & Right	+900	<p><b>A</b> Cast Aluminum legs with adjustable glides.</p> <p><b>W</b> Wood legs with adjustable glides.</p> 	<p><b>AL</b> <b>Cast Aluminum - Polished</b></p> <p><b>Cast Aluminum - Standard Powder Paint</b></p> <table border="0"> <tr> <td>BM Black Matte</td> <td>MK Milk</td> </tr> <tr> <td>BT Black Twilight</td> <td>NK Nickel</td> </tr> <tr> <td>BL Blue</td> <td>OR Orange</td> </tr> <tr> <td>CP Champagne</td> <td>RD Red</td> </tr> <tr> <td>DB Dark Bronze</td> <td>ST Sterling</td> </tr> <tr> <td>DC Dark Chocolate</td> <td>TP Taupe</td> </tr> <tr> <td>GR Green</td> <td>TS Textured Slate</td> </tr> <tr> <td>LB Light Bronze</td> <td>TI Titanium</td> </tr> <tr> <td>MF Metallic Fieldstone</td> <td>YL Yellow</td> </tr> <tr> <td>MS Metallic Silver</td> <td></td> </tr> </table> <p><b>Wood</b></p> <table border="0"> <tr> <td>81 White Oak</td> <td>+500</td> </tr> <tr> <td>83 Natural Maple</td> <td>+450</td> </tr> <tr> <td>85 Walnut</td> <td>+550</td> </tr> </table>	BM Black Matte	MK Milk	BT Black Twilight	NK Nickel	BL Blue	OR Orange	CP Champagne	RD Red	DB Dark Bronze	ST Sterling	DC Dark Chocolate	TP Taupe	GR Green	TS Textured Slate	LB Light Bronze	TI Titanium	MF Metallic Fieldstone	YL Yellow	MS Metallic Silver		81 White Oak	+500	83 Natural Maple	+450	85 Walnut	+550	<p>Yardages provided are for non-directional fabrics that are applied railroaded. Directional fabrics may require additional yardage.</p> <p>Thick quilted fabrics will be need to be verified and may be handled as a custom order.</p> <p>Refer to Stylex swatch cards and separately published in-graded fabric program to determine grades.</p> <p>See general information section in the main price list for CAL 133 information.</p>
Low-Back Corner	Fabric 1 Seat	1.6 yds.																																																																		
	Fabric 2 Back	2.4 yds.																																																																		
Low-Back Chaise	Fabric 1 Seat	2.4 yds.																																																																		
	Fabric 2 Back	1.5 yds.																																																																		
High-Back Corner	Fabric 1 Seat	1.6 yds.																																																																		
	Fabric 2 Back	4.3 yds.																																																																		
U1B1 Under Seat, 10' Cord, Black, Left	+450																																																																			
U1B2 Under Seat, 10' Cord, Black, Right	+450																																																																			
U1B3 Under Seat, 10' Cord, Black, Left & Right	+900																																																																			
U1W1 Under Seat, 10' Cord, White, Left	+450																																																																			
U1W2 Under Seat, 10' Cord, White, Right	+450																																																																			
U1W3 Under Seat, 10' Cord, White, Left & Right	+900																																																																			
U1G1 Under Seat, 10' Cord, Gray, Left	+450																																																																			
U1G2 Under Seat, 10' Cord, Gray, Right	+450																																																																			
U1G3 Under Seat, 10' Cord, Gray, Left & Right	+900																																																																			
BM Black Matte	MK Milk																																																																			
BT Black Twilight	NK Nickel																																																																			
BL Blue	OR Orange																																																																			
CP Champagne	RD Red																																																																			
DB Dark Bronze	ST Sterling																																																																			
DC Dark Chocolate	TP Taupe																																																																			
GR Green	TS Textured Slate																																																																			
LB Light Bronze	TI Titanium																																																																			
MF Metallic Fieldstone	YL Yellow																																																																			
MS Metallic Silver																																																																				
81 White Oak	+500																																																																			
83 Natural Maple	+450																																																																			
85 Walnut	+550																																																																			

**Metrum**  
Settee Double

Lounge

C.O.M.  
Fabric Upholstery  
Grades

Series	Model	Description/Yds.	C.O.M.	A	B	C	D	E	F	G	H	I	J	K	L	M
MT	32	<b>Settee Double</b>  C.O.M. yds. 6.6 Depth 33.75" Height 28" Seat Height 16" Width 66.875"	4,200	4,596	4,807	5,018	5,230	5,447	5,685	5,916	6,193	6,556	6,985	7,414	7,837	8,266

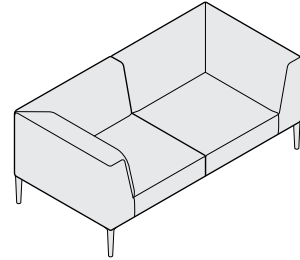

To Order follow steps 1-7

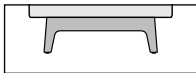
1 Series/Section	2 Welt Cord Options	3 Upholstery Options	4 Power Options	5 Leg Choice	6 Leg Finish Choices	7 Fabrics																										
<p>MT</p> <p>32 Settee Double</p>	<p>● <b>Welt Cord Options</b> Requires an additional 0.25 yds of fabric. Not available on quilted fabric.</p> <p>W3 Welt Cord on Seat and Back +115</p>	<p>● <b>Dual Fabric</b> The Dual Fabric Option allows for a second fabric to be applied to the seats. When specifying In-Graded fabrics, please apply the higher of the two grades.</p> <p>Settee Double Fabric 1 Seats 2.4 yds. Fabric 2 Backs 4.4 yds.</p>	<p>● <b>Power Options available on Chaise only</b></p> <p>U1B1 Under Seat, 10' Cord, Black, Left +450 U1B2 Under Seat, 10' Cord, Black, Right +450 U1B3 Under Seat, 10' Cord, Black, Left &amp; Right +900 U1W1 Under Seat, 10' Cord, White, Left +450 U1W2 Under Seat, 10' Cord, White, Right +450 U1W3 Under Seat, 10' Cord, White, Left &amp; Right +900 U1G1 Under Seat, 10' Cord, Gray, Left +450 U1G2 Under Seat, 10' Cord, Gray, Right +450 U1G3 Under Seat, 10' Cord, Gray, Left &amp; Right +900</p>	<p>● <b>A</b> Cast Aluminum legs with adjustable glides.</p> <p>● <b>W</b> Wood legs with adjustable glides.</p> 	<p>● <b>AL Cast Aluminum - Polished</b></p> <p>● <b>Cast Aluminum - Standard Powder Paint</b></p> <table border="0"> <tr> <td>BM Black Matte</td> <td>MK Milk</td> </tr> <tr> <td>BT Black Twilight</td> <td>NK Nickel</td> </tr> <tr> <td>BL Blue</td> <td>OR Orange</td> </tr> <tr> <td>CP Champagne</td> <td>RD Red</td> </tr> <tr> <td>DB Dark Bronze</td> <td>ST Sterling</td> </tr> <tr> <td>DC Dark Chocolate</td> <td>TP Taupe</td> </tr> <tr> <td>GR Green</td> <td>TS Textured Slate</td> </tr> <tr> <td>LB Light Bronze</td> <td>TI Titanium</td> </tr> <tr> <td>MF Metallic Fieldstone</td> <td>YL Yellow</td> </tr> <tr> <td>MS Metallic Silver</td> <td></td> </tr> </table> <p>● <b>Wood</b></p> <table border="0"> <tr> <td>81 White Oak</td> <td>+640</td> </tr> <tr> <td>83 Natural Maple</td> <td>+550</td> </tr> <tr> <td>85 Walnut</td> <td>+720</td> </tr> </table>	BM Black Matte	MK Milk	BT Black Twilight	NK Nickel	BL Blue	OR Orange	CP Champagne	RD Red	DB Dark Bronze	ST Sterling	DC Dark Chocolate	TP Taupe	GR Green	TS Textured Slate	LB Light Bronze	TI Titanium	MF Metallic Fieldstone	YL Yellow	MS Metallic Silver		81 White Oak	+640	83 Natural Maple	+550	85 Walnut	+720	<p>● Yardages provided are for non-directional fabrics that are applied railroaded. Directional fabrics may require additional yardage.</p> <p>Thick quilted fabrics will be need to be verified and may be handled as a custom order.</p> <p>Refer to Stylex swatch cards and separately published in-graded fabric program to determine grades.</p> <p>See general information section in the main price list for CAL 133 information.</p>
BM Black Matte	MK Milk																															
BT Black Twilight	NK Nickel																															
BL Blue	OR Orange																															
CP Champagne	RD Red																															
DB Dark Bronze	ST Sterling																															
DC Dark Chocolate	TP Taupe																															
GR Green	TS Textured Slate																															
LB Light Bronze	TI Titanium																															
MF Metallic Fieldstone	YL Yellow																															
MS Metallic Silver																																
81 White Oak	+640																															
83 Natural Maple	+550																															
85 Walnut	+720																															

# Metrum

## Modular Benches

### Lounge

C.O.M.  
Fabric Upholstery  
Grades

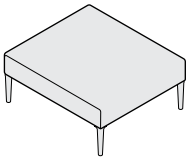
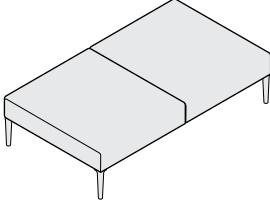
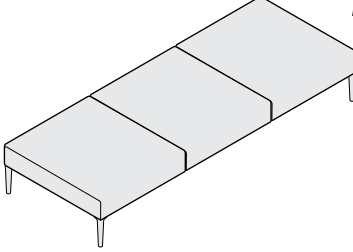
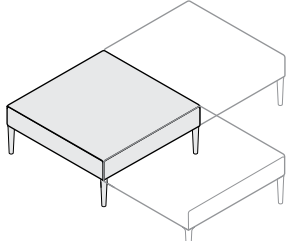
Series Model	Description/Yds.	C.O.M.	A	B	C	D	E	F	G	H	I	J	K	L	M
 MT 01	<b>Bench Single</b>  C.O.M. yds. 2.1 Depth 33.75" Height 16" Width 29.75"	1,175	1,301	1,368	1,435	1,503	1,572	1,648	1,721	1,809	1,925	2,061	2,198	2,332	2,469
 MT 02	<b>Bench Double</b>  C.O.M. yds. 3.0 Depth 33.75" Height 16" Width 59.5"	2,000	2,180	2,276	2,372	2,468	2,567	2,675	2,780	2,906	3,071	3,266	3,461	3,653	3,848
 MT 03	<b>Bench Triple</b>  C.O.M. yds.. 4.1 Depth 33.75" Height 16" Width 89.25"	2,700	2,946	3,077	3,208	3,340	3,475	3,623	3,766	3,938	4,164	4,430	4,697	4,959	5,226
 MT 04	<b>Bench Corner</b>  C.O.M. yds. 2.2 Depth 33.5" Height 16" Width 33.5"	1,200	1,332	1,402	1,473	1,543	1,616	1,695	1,772	1,864	1,985	2,128	2,271	2,412	2,555

To Order follow steps 1-6

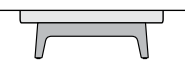
1 Series/Section	2 Welt Cord Options	3 Power Options	4 Leg Choice	5 Leg Finish Choices	6 Fabrics																										
<p>MT</p> <ul style="list-style-type: none"> <li>01 Bench Single</li> <li>02 Bench Double</li> <li>03 Bench Triple</li> <li>04 Bench Corner</li> </ul>	<p>● <b>Welt Cord Options</b> Requires an additional 0.25 yds of fabric. Not available on quilted fabric.</p> <p>W1 Welt Cord on Seats +50 (per seat)</p>	<p>● <b>Power Options</b></p> <ul style="list-style-type: none"> <li>U1B1 Under Seat, 10' Cord, Black, Left +450</li> <li>U1B2 Under Seat, 10' Cord, Black, Right +450</li> <li>U1B3 Under Seat, 10' Cord, Black, Left &amp; Right +900</li> <li>U1W1 Under Seat, 10' Cord, White, Left +450</li> <li>U1W2 Under Seat, 10' Cord, White, Right +450</li> <li>U1W3 Under Seat, 10' Cord, White, Left &amp; Right +900</li> <li>U1G1 Under Seat, 10' Cord, Gray, Left +450</li> <li>U1G2 Under Seat, 10' Cord, Gray, Right +450</li> <li>U1G3 Under Seat, 10' Cord, Gray, Left &amp; Right +900</li> </ul>	<p>○ <b>A</b> Cast Aluminum legs with adjustable glides.</p> <p>○ <b>W</b> Wood legs with adjustable glides.</p> 	<p>○ <b>AL</b> Cast Aluminum - Polished</p> <p>● <b>Cast Aluminum - Standard Powder Paint</b></p> <table border="0"> <tr> <td>BM Black Matte</td> <td>MK Milk</td> </tr> <tr> <td>BT Black Twilight</td> <td>NK Nickel</td> </tr> <tr> <td>BL Blue</td> <td>OR Orange</td> </tr> <tr> <td>CP Champagne</td> <td>RD Red</td> </tr> <tr> <td>DB Dark Bronze</td> <td>ST Sterling</td> </tr> <tr> <td>DC Dark Chocolate</td> <td>TP Taupe</td> </tr> <tr> <td>GR Green</td> <td>TS Textured Slate</td> </tr> <tr> <td>LB Light Bronze</td> <td>TI Titanium</td> </tr> <tr> <td>MF Metallic Fieldstone</td> <td>YL Yellow</td> </tr> <tr> <td>MS Metallic Silver</td> <td></td> </tr> </table> <p>● <b>Wood</b></p> <table border="0"> <tr> <td>81 White Oak</td> <td>+640</td> </tr> <tr> <td>83 Natural Maple</td> <td>+550</td> </tr> <tr> <td>85 Walnut</td> <td>+720</td> </tr> </table>	BM Black Matte	MK Milk	BT Black Twilight	NK Nickel	BL Blue	OR Orange	CP Champagne	RD Red	DB Dark Bronze	ST Sterling	DC Dark Chocolate	TP Taupe	GR Green	TS Textured Slate	LB Light Bronze	TI Titanium	MF Metallic Fieldstone	YL Yellow	MS Metallic Silver		81 White Oak	+640	83 Natural Maple	+550	85 Walnut	+720	<p>● Yardages provided are for non-directional fabrics that are applied railroaded. Directional fabrics may require additional yardage.</p> <p>Thick quilted fabrics will be need to be verified and may be handled as a custom order.</p> <p>Refer to Stylex swatch cards and separately published in-graded fabric program to determine grades.</p> <p>See general information section in the main price list for CAL 133 information.</p>
BM Black Matte	MK Milk																														
BT Black Twilight	NK Nickel																														
BL Blue	OR Orange																														
CP Champagne	RD Red																														
DB Dark Bronze	ST Sterling																														
DC Dark Chocolate	TP Taupe																														
GR Green	TS Textured Slate																														
LB Light Bronze	TI Titanium																														
MF Metallic Fieldstone	YL Yellow																														
MS Metallic Silver																															
81 White Oak	+640																														
83 Natural Maple	+550																														
85 Walnut	+720																														

# Metrum

## Modular Arms

### Lounge

C.O.M.  
Fabric Upholstery  
Grades

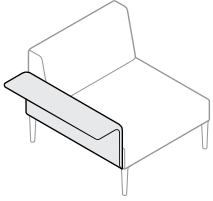
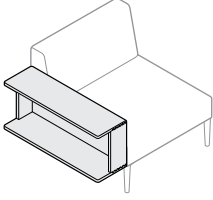
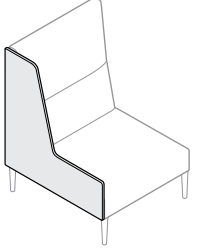
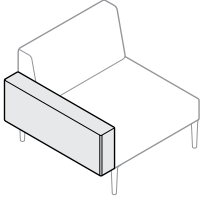
Series	Model	Description/Yds.	Wood Finish	C.O.M.	A	B	C	D	E	F	G	H	I	J	K	L	M
	MT 41	<b>Cantilever Arm</b> C.O.M. yds. 0.6 Depth 33.25" Height 13.5" Width 9.125"		500	536	555	574	594	613	635	656	681	714	753	792	831	870
	MT 42	<b>Bookshelf Arm</b> Depth 33" Height 14.0" Width 10"	White Oak 1,800 Natural Maple 2,000 Walnut 2,400														
	MT 43	<b>Privacy Arm</b> C.O.M. yds.. 1.7 Depth 33.5 Height 12" Width 2"		300	402	456	511	565	621	683	742	813	907	1,017	1,128	1,237	1,347
	MT 44	<b>Standard Arm</b> C.O.M. yds. 1.5 Depth 33.75" Height 13" Width 5.75"		370	460	508	556	604	654	708	760	823	906	1,003	1,101	1,197	1,294

To Order follow steps 1-5

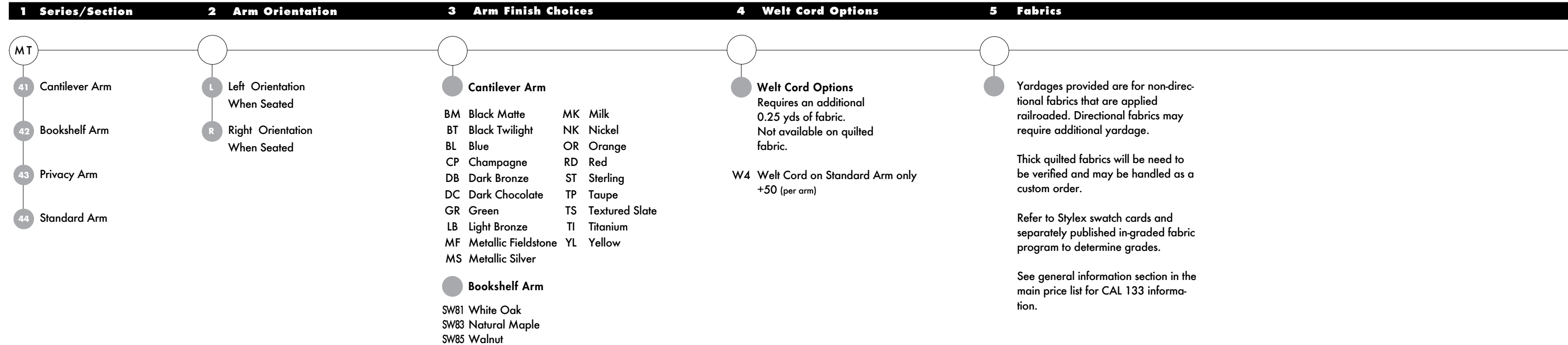

**Metrum**  
Modular Mid Arms

Lounge

C.O.M.  
Fabric Upholstery  
Grades

Series	Model	Description/Yds.	Wood Finish	C.O.M.	A	B	C	D	E	F	G	H	I	J	K	L	M	
	MT	45	<b>Mid Arm Wood</b>	White Oak 775 Natural Maple 800 Walnut 900														
			Depth 22" Height 3" Width 7.5"															
	MT	46	<b>Mid Arm Upholstered</b>		500	566	601	636	672	708	748	786	832	893	964	1,036	1,106	1,178
			C.O.M. yds.. 1.1 Depth 22.5" Height 4.25" Width 8"															

To Order follow steps 1-3

**1 Series/Section      2 Arm Finish Choices      3 Fabrics**

MT

45 Mid Arm Wood

46 Mid Arm Upholstered

○

● Wood Arm

SW81 White Oak  
SW83 Natural Maple  
SW85 Walnut

○

● Yardages provided are for non-directional fabrics that are applied railroaded. Directional fabrics may require additional yardage.

Thick quilted fabrics will be need to be verified and may be handled as a custom order.

Refer to Stylex swatch cards and separately published in-graded fabric program to determine grades.

See general information section in the main price list for CAL 133 information.



# Metrum

## Full Tables

### Lounge

Table Material Selection

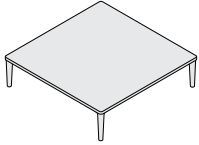
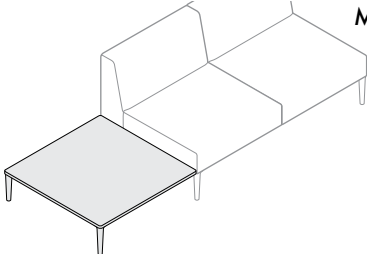
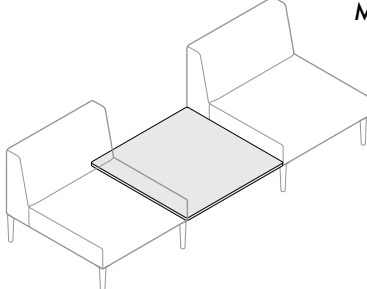
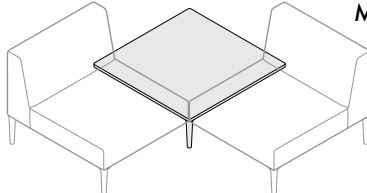
Series Model	Description	CS Caesarstone	SS Solid Surface	SW Solid Wood
 MT 51	<b>Full Stand-Alone Table</b> Depth 33.5" Height 9.25 - 9.5" Width 33.5"	51 Jet Black 3,800 52 Sleek Concrete 3,800 53 Haze 3,800 65 Pure White 4,900 96 Statuario Nuvo 6,200	01 Arctic White 2,000 03 Ivory White 2,000 04 Grey 2,550 05 Steel Grey 3,400 06 Black 3,000	81 White Oak 1,310 83 Natural Maple 1,180 85 Walnut 1,780
 MT 52	<b>Full End Table</b> Depth 33.5" Height 9.25 - 9.5" Width 33.5"	51 Jet Black 3,700 52 Sleek Concrete 3,700 53 Haze 3,700 65 Pure White 4,800 96 Statuario Nuvo 6,100	01 Arctic White 1,900 03 Ivory White 1,900 04 Grey 2,450 05 Steel Grey 3,300 06 Black 2,900	81 White Oak 1,210 83 Natural Maple 1,080 85 Walnut 1,680
 MT 53	<b>Full Mid Table</b> Depth 33.5" Height 9.25 - 9.5" Width 33.5"	51 Jet Black 3,700 52 Sleek Concrete 3,700 53 Haze 3,700 65 Pure White 4,800 96 Statuario Nuvo 6,100	01 Arctic White 1,900 03 Ivory White 1,900 04 Grey 2,450 05 Steel Grey 3,300 06 Black 2,900	81 White Oak 1,210 83 Natural Maple 1,080 85 Walnut 1,680
 MT 54	<b>Full Corner Table</b> Depth 33.5" Height 9.25 - 9.5" Width 33.5"	51 Jet Black 3,800 52 Sleek Concrete 3,800 53 Haze 3,800 65 Pure White 4,900 96 Statuario Nuvo 6,200	01 Arctic White 2,000 03 Ivory White 2,000 04 Grey 2,550 05 Steel Grey 3,400 06 Black 3,000	81 White Oak 1,310 83 Natural Maple 1,180 85 Walnut 1,780

To Order follow steps 1-5

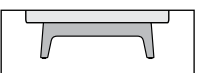
1 Series/Section	2 Table Material	3 Power Options	4 Leg Choice	5 Leg Finish Choices
<ul style="list-style-type: none"> <li>MT</li> <li>51 Full Stand-Alone Table</li> <li>52 Full End Table</li> <li>53 Full Mid Table</li> <li>54 Full Corner Table</li> </ul>	<ul style="list-style-type: none"> <li>Caesarstone Tops                             <ul style="list-style-type: none"> <li>CS51 Jet Black</li> <li>CS52 Sleek Concrete</li> <li>CS53 Haze</li> <li>CS65 Pure White</li> <li>CS96 Statuario Nuvo</li> </ul> </li> <li>Solid Surface Tops                             <ul style="list-style-type: none"> <li>SS01 Arctic White</li> <li>SS03 Ivory White</li> <li>SS04 Grey</li> <li>SS05 Steel Grey</li> <li>SS06 Black</li> </ul> </li> <li>Solid Wood Tops                             <ul style="list-style-type: none"> <li>SW81 White Oak</li> <li>SW83 Natural Maple</li> <li>SW85 Walnut</li> </ul> </li> </ul>	<ul style="list-style-type: none"> <li>Power Options                             <ul style="list-style-type: none"> <li>S1B Table Surface, 10' Cord, Black +450</li> <li>S1W Table Surface, 10' Cord, White +450</li> <li>S1G Table Surface, 10' Cord, Gray +450</li> <li>S2B Table Surface, 20' Cord, Black +475</li> <li>S2W Table Surface, 20' Cord, White +475</li> <li>S2G Table Surface, 20' Cord, Gray +475</li> </ul> </li> </ul>	<ul style="list-style-type: none"> <li>A Cast Aluminum legs with adjustable glides.</li> <li>W Wood legs with adjustable glides.</li> </ul> 	<ul style="list-style-type: none"> <li>AL Cast Aluminum - Polished</li> <li>Cast Aluminum - Standard Powder Paint                             <ul style="list-style-type: none"> <li>BM Black Matte</li> <li>BT Black Twilight</li> <li>BL Blue</li> <li>CP Champagne</li> <li>DB Dark Bronze</li> <li>DC Dark Chocolate</li> <li>GR Green</li> <li>LB Light Bronze</li> <li>MF Metallic Fieldstone</li> <li>MS Metallic Silver</li> <li>MK Milk</li> <li>NK Nickel</li> <li>OR Orange</li> <li>RD Red</li> <li>ST Sterling</li> <li>TP Taupe</li> <li>TS Textured Slate</li> <li>TI Titanium</li> <li>YL Yellow</li> </ul> </li> <li>Wood                             <ul style="list-style-type: none"> <li>81 White Oak +640</li> <li>83 Natural Maple +550</li> <li>85 Walnut +720</li> </ul> </li> </ul>

# Metrum

## Half Tables

### Lounge

Table Material Selection

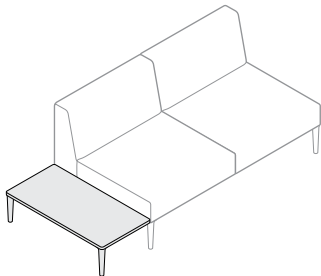
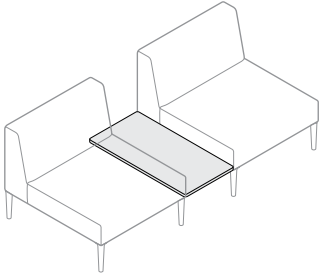
Series Model	Description	CS Caesarstone	SS Solid Surface	SW Solid Wood
	<b>MT 56 Half End Table</b> Depth 33.5" Height 9.25 - 9.5" Width 20"	51 Jet Black 3,550 52 Sleek Concrete 3,550 53 Haze 3,550 65 Pure White 4,050 96 Statuario Nuvo 4,100	01 Arctic White 1,550 03 Ivory White 1,550 04 Grey 1,950 05 Steel Grey 2,700 06 Black 2,450	81 White Oak 880 83 Natural Maple 800 85 Walnut 1,190
		<b>MT 57 Half Mid Table</b> Depth 33.5" Height 9.25 - 9.5" Width 20"	51 Jet Black 3,550 52 Sleek Concrete 3,550 53 Haze 3,550 65 Pure White 4,050 96 Statuario Nuvo 4,100	01 Arctic White 1,550 03 Ivory White 1,550 04 Grey 1,950 05 Steel Grey 2,700 06 Black 2,450

To Order follow steps 1-5

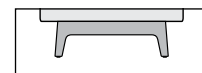
1 Series/Section	2 Table Material	3 Power Options	4 Leg Choice	5 Leg Finish Choices
MT 56 Half End Table 57 Half Mid Table	<b>Caesarstone Tops</b> CS51 Jet Black CS52 Sleek Concrete CS53 Haze CS65 Pure White CS96 Statuario Nuvo <b>Solid Surface Tops</b> SS01 Arctic White SS03 Ivory White SS04 Grey SS05 Steel Grey SS06 Black <b>Solid Wood Tops</b> SW81 White Oak SW83 Natural Maple SW85 Walnut	<b>Power Options</b> S1B Table Surface, 10' Cord, Black +450 S1W Table Surface, 10' Cord, White +450 S1G Table Surface, 10' Cord, Gray +450 S2B Table Surface, 20' Cord, Black +475 S2W Table Surface, 20' Cord, White +475 S2G Table Surface, 20' Cord, Gray +475	<b>Leg Choice</b> A Cast Aluminum legs with adjustable glides. W Wood legs with adjustable glides. 	<b>Leg Finish Choices</b> <b>Cast Aluminum - Polished</b> <b>Cast Aluminum - Standard Powder Paint</b> BM Black Matte    MK Milk BT Black Twilight    NK Nickel BL Blue    OR Orange CP Champagne    RD Red DB Dark Bronze    ST Sterling DC Dark Chocolate    TP Taupe GR Green    TS Textured Slate LB Light Bronze    TI Titanium MF Metallic Fieldstone    YL Yellow MS Metallic Silver <b>Wood</b> 81 White Oak +640 83 Natural Maple +550 85 Walnut +720