

Prices Effective
July 1, 2018

STYLFEE X

Yoom Rolled Soft

Price List

Yoom Rolled Soft - A La Carte

Product Information Applications:

Modular Lounge Systems

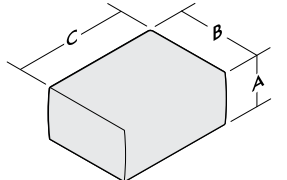
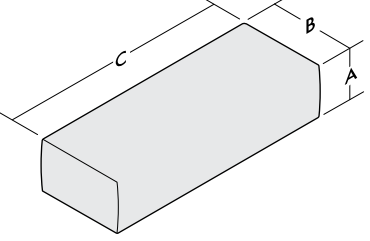
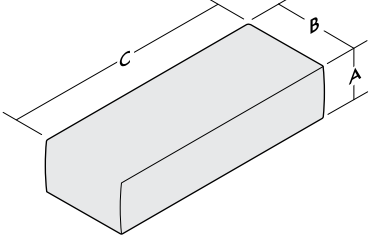
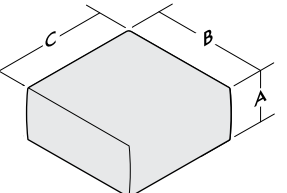
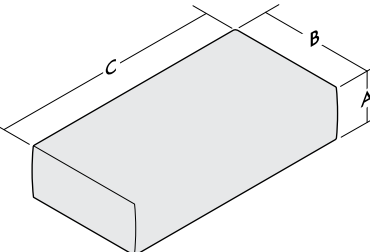
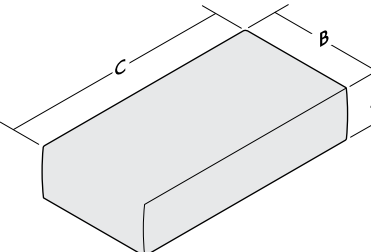
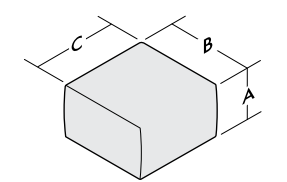
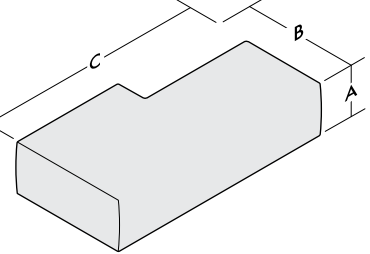
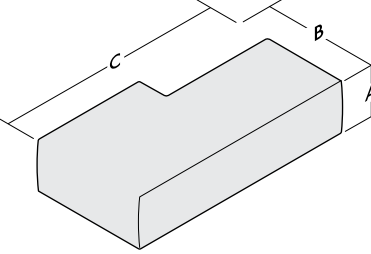
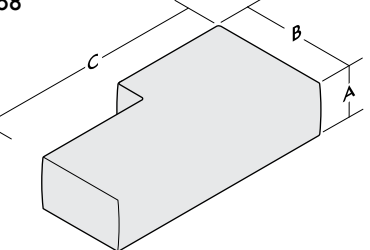
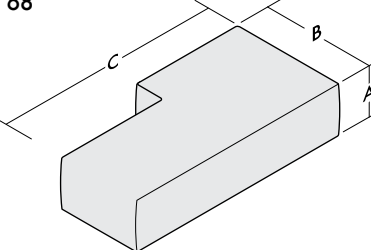
Dimensions / Overview	Single Seat	Double Seat/Chaise Seat	Double Seat/Chaise Seat	General Information
General Dimensions A. Height B. Depth C. Width	Single Seat A. 15" B. 25" C. 34" 	Double Seat A. 15" B. 25" C. 68" 	Double Seat A. 15" B. 25" C. 68" 	Design Stylex/Anthony Land Construction Internal frames are built from 5/8" PS 1-09 certified plywood. All surfaces are covered with foam of varying thicknesses and densities, depending on the particular unit. Chairs incorporate Dymetrol webbing in the seat for added comfort. Ganging All individual units may be connected to one another with the use of a forked latch system.
	Single Full Seat A. 15" B. 34" C. 34" 	Double Full Seat A. 15" B. 34" C. 68" 	Double Full Seat A. 15" B. 34" C. 68" 	Glides Yoom Rolled Soft is available with 3 glide options: plastic, rubber, and felt. Casters Yoom Rolled Soft is available with 2 caster options: hard and soft. Power Optional power receptacle offers three exposed power ports: 2 USB 2.1A ports and a standard, grounded 3-prong electrical outlet.
	Single Narrow Seat A. 15" B. 25" C. 25" 	Chaise Right A. 15" B. 34" C. 68" 	Chaise Right A. 15" B. 34" C. 68" 	Testing Manufactured to comply with ANSI/BIFMA X5.4 Lounge Seating Tests. Environment Greenguard Certified.
		Chaise Left A. 15" B. 34" C. 68" 	Chaise Left A. 15" B. 34" C. 68" 	

Please note that there is 1" of clearance between the floor and all Yoom components.

Yoom Rolled Soft - A La Carte

Product Information Applications:

Modular Lounge Systems

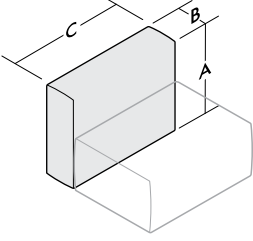
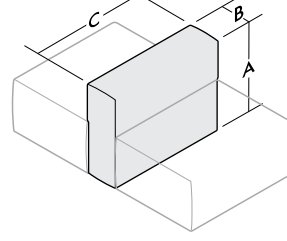
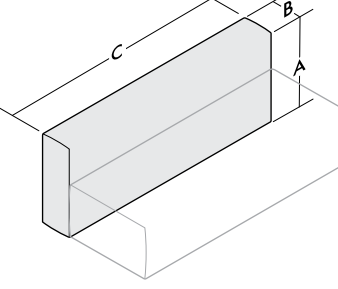
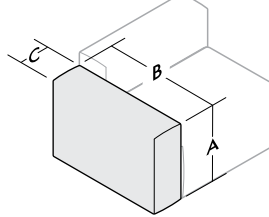
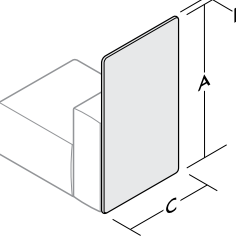
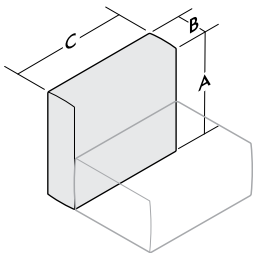
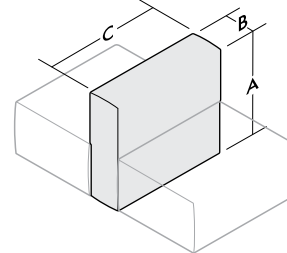
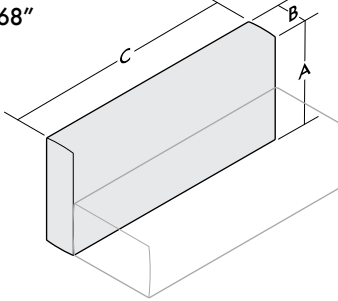
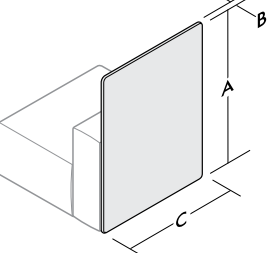
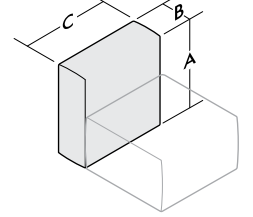
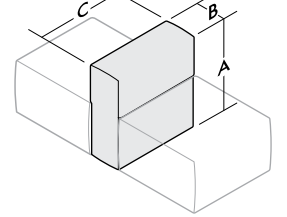
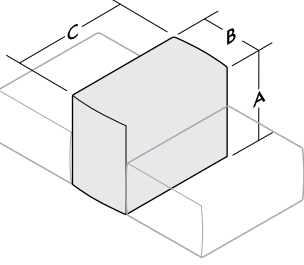
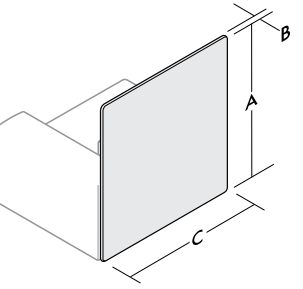
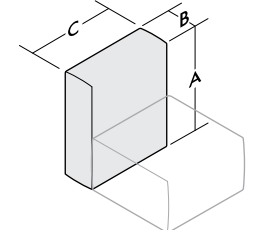
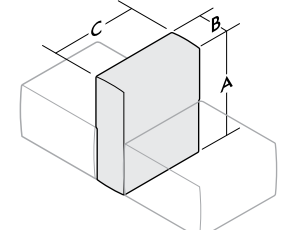
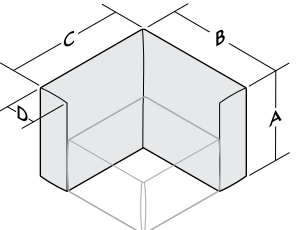
Dimensions / Overview	Single Back	Single Thin Back to Back	Double Back	Arm	Screens	General Information
General Dimensions A. Height B. Depth C. Width	Single Back A. 26" B. 9" C. 34" 	Single Thin Back to Back A. 26" B. 9" C. 34" 	Double Back A. 26" B. 9" C. 68" 	Single Low Arm A. 22" B. 34" C. 9" 	25" Privacy Screen A. 45" B. 1.5" C. 25" 	Design Stylex/Anthony Land Construction Internal frames are built from 5/8" PS 1-09 certified plywood. All surfaces are covered with foam of varying thicknesses and densities, depending on the particular unit. Chairs incorporate Dymetrol webbing in the seat for added comfort. Ganging All individual units may be connected to one another with the use of a forked latch system. Glides Yoom Rolled Soft is available with 3 glide options: plastic, rubber, and felt. Casters Yoom Rolled Soft is available with 2 caster options: hard and soft. Power Optional power receptacle offers three exposed power ports: 2 USB 2.1A ports and a standard, grounded 3-prong electrical outlet. Testing Manufactured to comply with ANSI/BIFMA X5.4 Lounge Seating Tests. Environment Greenguard Certified.
	Single High Back A. 30" B. 9" C. 34" 	Single High Thin Back to Back A. 30" B. 9" C. 34" 	Double High Back A. 30" B. 9" C. 68" 		34" Privacy Screen A. 45" B. 1.5" C. 34" 	
	Single Narrow Back A. 26" B. 9" C. 25" 	Single Narrow Thin Back to Back A. 26" B. 9" C. 25" 	Back to Back A. 26" B. 18" C. 34" 		43" Privacy Screen A. 45" B. 1.5" C. 43" 	
	Single Narrow High Back A. 30" B. 9" C. 25" 	Single Narrow High Thin Back to Back A. 30" B. 9" C. 25" 	Corner Back A. 26" B. 34" C. 34" D. 9" 			

Please note that there is 1" of clearance between the floor and all Yoom components.

Yoom Rolled Soft

Product Information Applications - Chairs

Modular Lounge Systems

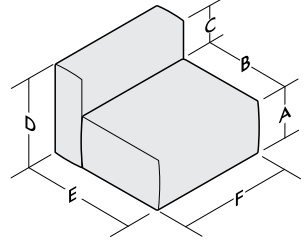
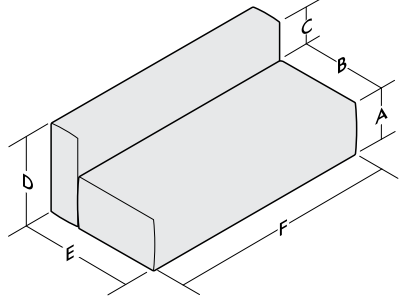
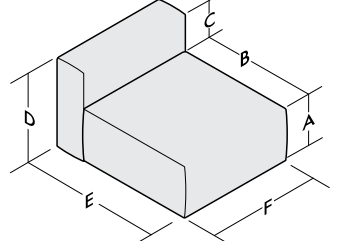
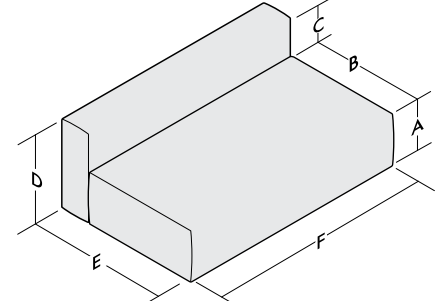
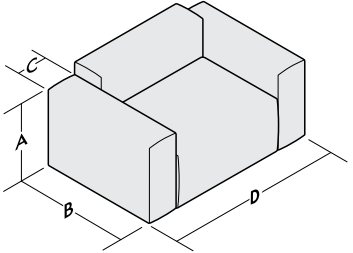
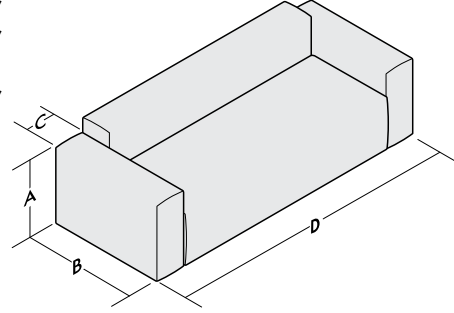
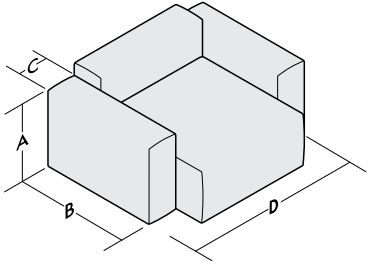
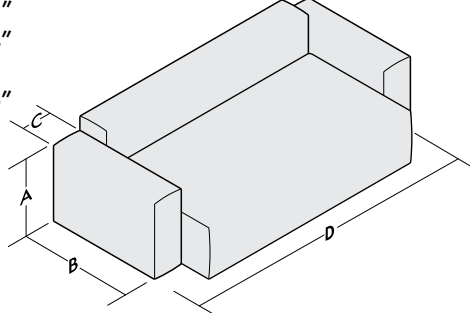
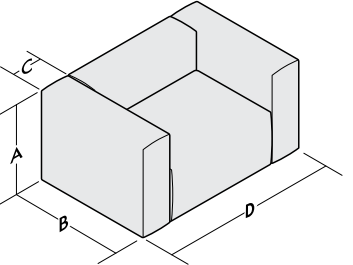
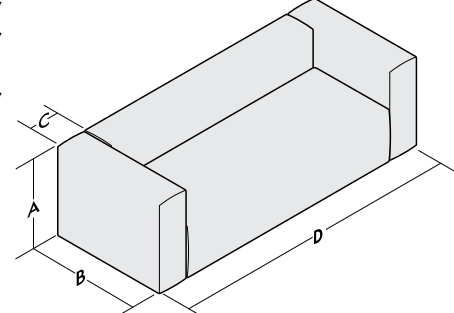
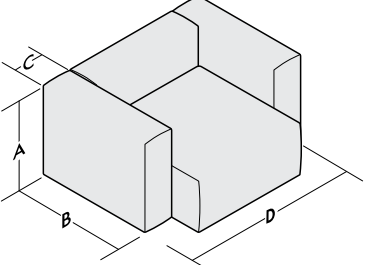
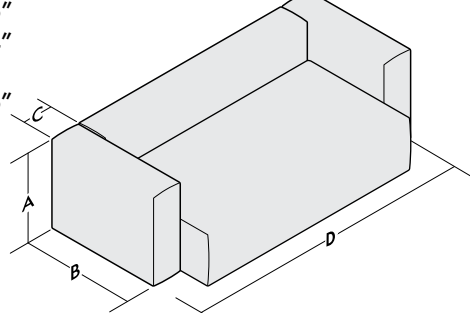
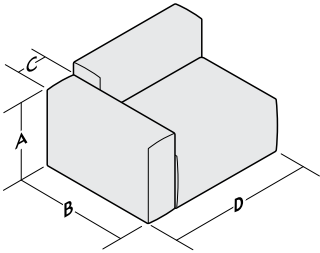
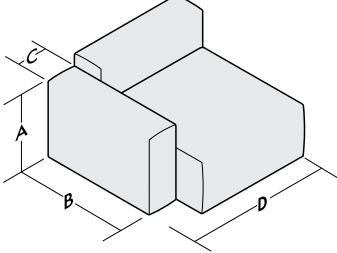
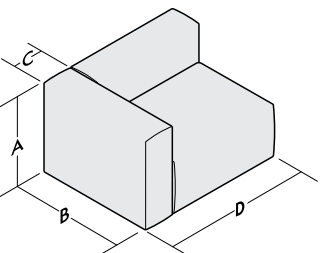
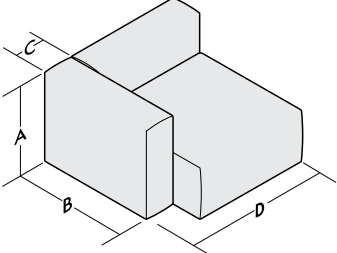
Dimensions / Overview	Single Chair	Double Chair	Single Full Chair	Double Full Chair	General Information
General Dimensions A. Seat Height B. Seat Depth C. Back Height D. Overall Height E. Overall Depth F. Overall Width	Single Chair Armless A. 15" B. 25" C. 11" D. 26" E. 34" F. 34" 	Double Chair Armless A. 15" B. 25" C. 11" D. 26" E. 34" F. 68" 	Single Full Chair Armless A. 15" B. 34" C. 11" D. 26" E. 43" F. 34" 	Double Full Chair Armless A. 15" B. 34" C. 11" D. 26" E. 43" F. 68" 	Design Stylex/Anthony Land Construction Internal frames are built from 5/8" PS 1-09 certified plywood. Multi-density foam combined with a 50/50 down and feather cover is utilized to provide a lofted relaxed look. Chairs incorporate Dymetrol webbing in the seat for added comfort. Ganging All individual units may be connected to one another with the use of a forked latch system.
Arms Low A. Height B. Depth C. Width D. Overall Width Arms	Single Chair Low Arms A. 22" B. 34" C. 9" D. 52" 	Double Chair Low Arms A. 22" B. 34" C. 9" D. 86" 	Single Full Chair Low Arms A. 22" B. 34" C. 9" D. 52" 	Double Full Chair Low Arms A. 22" B. 34" C. 9" D. 86" 	Glides Yoom Rolled Soft is available with 3 glide options: plastic, rubber, and felt. Casters Yoom Rolled Soft is available with 2 caster options: hard and soft. Power Optional power receptacle offers three exposed power ports: 2 USB 2.1A ports and a standard, grounded 3-prong electrical outlet.
Arms High A. Height B. Depth C. Width D. Overall Width Arms	Single Chair High Arms A. 26" B. 34" C. 9" D. 52" 	Double Chair High Arms A. 26" B. 34" C. 9" D. 86" 	Single Full Chair High Arms A. 26" B. 34" C. 9" D. 52" 	Double Full Chair High Arms A. 26" B. 34" C. 9" D. 86" 	Testing Manufactured to comply with ANSI/BIF-MA X5.4 Lounge Seating Tests. Environment Greenguard Certified.
Arm Low Right or Left A. Height B. Depth C. Width D. Overall Width with Arm	Single Chair with Right Low Arm A. 22" B. 34" C. 9" D. 43" 		Single Full Chair with Right Low Arm A. 22" B. 34" C. 9" D. 43" 		
Arm High Right or Left A. Height B. Depth C. Width D. Overall Width with Arm	Single Chair with Right High Arm A. 26" B. 34" C. 9" D. 43" 		Single Full Chair with Right High Arm A. 26" B. 34" C. 9" D. 43" 		

Yoom Rolled Soft

Product Information Applications - Chairs



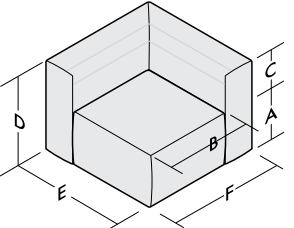
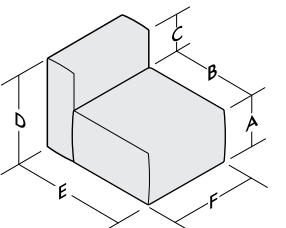
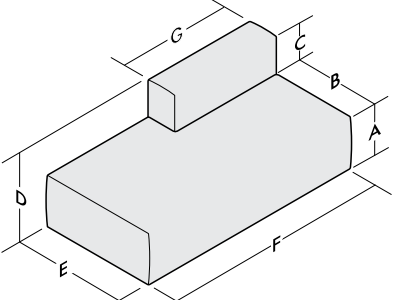
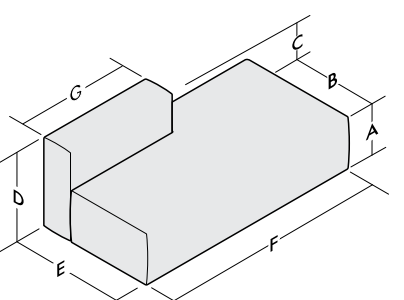

Modular Lounge Systems

Dimensions / Overview	Corner Chair	Single Narrow Chair	Chaise Right	Chaise Left	
<p>General Dimensions</p> <ul style="list-style-type: none"> A. Seat Height B. Seat Depth C. Back Height D. Overall Height E. Overall Depth F. Overall Width G. Back Width 	<p>Corner Chair</p> <ul style="list-style-type: none"> A. 15" B. 25" C. 11" D. 26" E. 34" F. 34" G. 34" 	<p>Single Narrow Chair</p> <ul style="list-style-type: none"> A. 15" B. 25" C. 11" D. 26" E. 34" F. 25" G. 34" 	<p>Chaise Right</p> <p>Rolled Front Shown</p> <ul style="list-style-type: none"> A. 15" B. 25" C. 11" D. 26" E. 34" F. 68" G. 34" 	<p>Chaise Left</p> <p>Rolled Front Shown</p> <ul style="list-style-type: none"> A. 15" B. 25" C. 11" D. 26" E. 34" F. 68" G. 34" 	<p>Design Stylex/Anthony Land</p> <p>Construction Internal frames are built from 5/8" PS 1-09 certified plywood. All surfaces are covered with foam of varying thicknesses and densities, depending on the particular unit. Chairs incorporate Dymetrol webbing in the seat for added comfort.</p> <p>Ganging All individual units may be connected to one another with the use of a forked latch system.</p> <p>Glides Yoom Rolled Soft is available with 3 glide options: plastic, rubber, and felt.</p> <p>Casters Yoom Rolled Soft is available with 2 caster options: hard and soft.</p> <p>Power Optional power receptacle offers three exposed power ports: 2 USB 2.1A ports and a standard, grounded 3-prong electrical outlet.</p> <p>Testing Manufactured to comply with ANSI/BIF-MA X5.4 Lounge Seating Tests.</p> <p>Environment Greenguard Certified.</p>

Yoom Rolled Soft

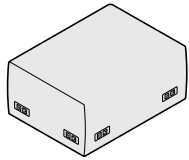
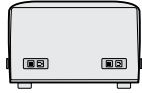
Rolled Soft - Power Port Options

Modular Lounge Systems

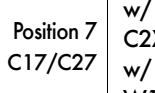
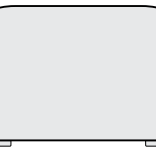
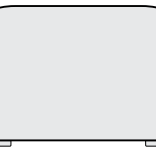
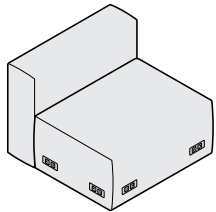
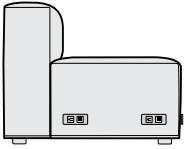
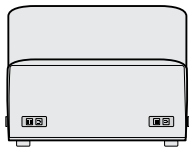
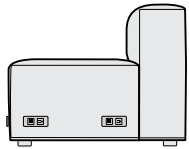
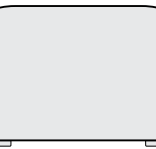
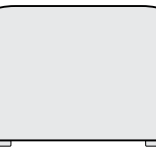
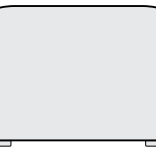
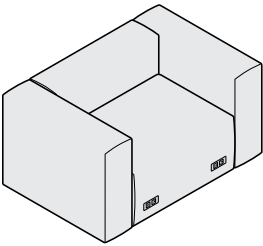
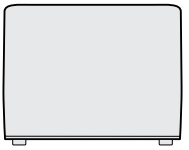
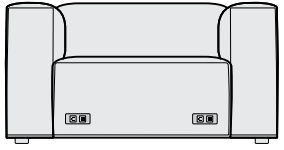
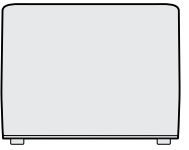
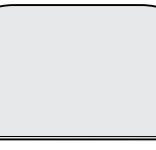
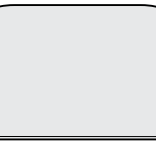
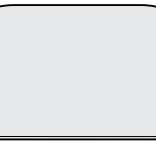
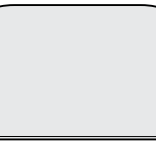
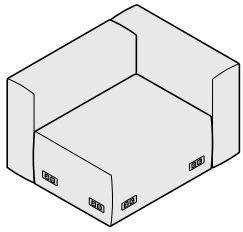
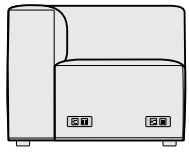
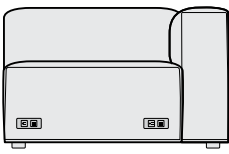
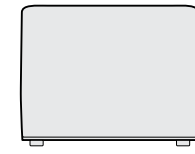
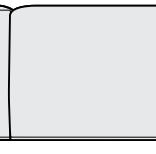
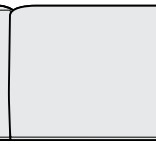
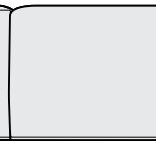
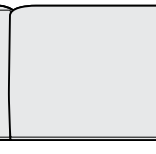
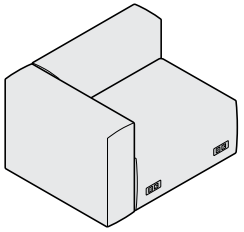
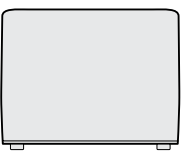
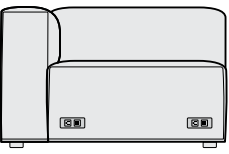
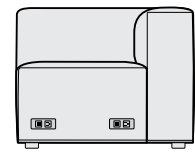
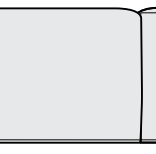
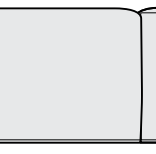
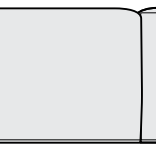
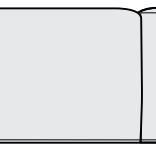
	Right Side	Front	Left Side	Back	General Information				
Single Seat Power Port Option(s)	 Position 5 C15/C25	 Position 4 C14/C24	 Position 3 C13/C23	 Position 2 C12/C22	 Position 1 C11/C21	 Position 8 C18/C28	 Position 6 C16/C26	 Position 7 C17/C27	<p>In-Seat Power Ports With 10' Or 20' Cord</p> <p>Power Port Cord Length and Harness End C1X has a 10' power cord w/ NEMA 5-15P C2X has a 20' Power cord w/ NEMA 5-15P W1X 12' BX whip (for hardwiring) W1X 24' BX whip (for hardwiring)</p> <p>Power Port Location The power port location is determined by its last digit.</p> <p>Examples:</p> <ul style="list-style-type: none"> A C14 power port has a 10' power cord and is located on the right side of a chair, as determined from a seated position, or the right forward position of a bench. A C21 power port has a 20' power cord and is located on the left side of a chair, as determined from a seated position, or the left forward position of a bench. <p>Multiple power ports may be ordered per unit. The pricing shown is for each power port ordered.</p> <p>In-Seat Power Port Finish Select power port finish from one of the standard Stylex powder paints.</p> <p>Power In Chairs And Benches Power receptacle offers three exposed power ports: 2 USB 2.1A ports and a standard, grounded 3-prong electrical outlet.</p>
Single Chair Power Port Option(s)	 Position 5 C15/C25	 Position 4 C14/C24	 Position 3 C13/C23	 Position 2 C12/C22	 Position 1 C11/C21	 Position 8 C18/C28	No Ports		
Chair w/Arms Power Port Option(s)	 No Ports	 No Ports	 Position 3 C13/C23	 Position 2 C12/C22	 No Ports	 No Ports	 No Ports		
Single Chair w/Left Arm Power Port Option(s)	 Position 5 C15/C25	 Position 4 C14/C24	 Position 3 C13/C23	 Position 2 C12/C22	 No Ports	 No Ports	 No Ports		
Single Chair w/Right Arm Power Port Option(s)	 No Ports	 No Ports	 Position 3 C13/C23	 Position 2 C12/C22	 Position 1 C11/C21	 Position 8 C18/C28	 No Ports		

Power Port Ordering

Options-Power Port Configuration

Length and Harness End
C1X 10' cord length w/ NEMA 5-15P
C2X 20' cord length w/ NEMA 5-15P
W1X 12' BX whip (for hardwiring)
W1X 24' BX whip (for hardwiring)

Option Power Port Position
Position 1 thru 8
See above for power port location restrictions.

Option Power Port Finish

BM Black Matte	GR Green	OR Orange
BT Black Twilight	LB Light Bronze	RD Red
BL Blue	LG Light Gray	ST Sterling
BR Brass	MF Metallic Fieldstone	TP Taupe
CP Champagne	MS Metallic Silver	TS Textured Slate
DB Dark Bronze	MK Milk	TI Titanium
DC Dark Chocolate	NK Nickel	YL Yellow

Example: C2 3 BM

Option Black Matte Finish
Option Power Port Position(s)
Option 20' Cord Length

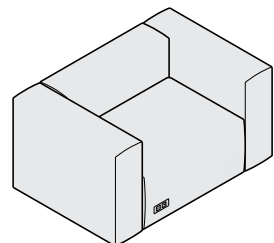

Yoom Rolled Soft

Product Information Applications - Rolled Side

Modular Lounge Systems

Double Seat - Rolled Side Soft

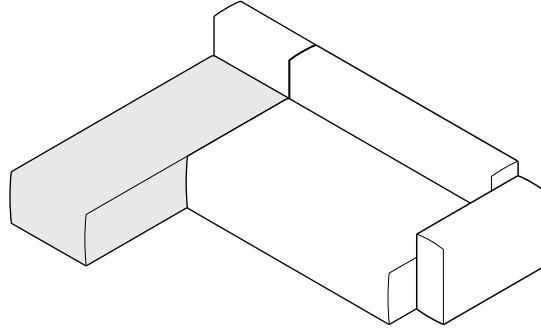

Double Full Seat - Rolled Side Soft

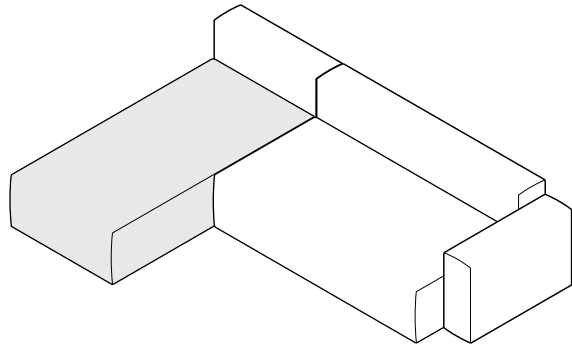

Chaise Right - Rolled Side Soft

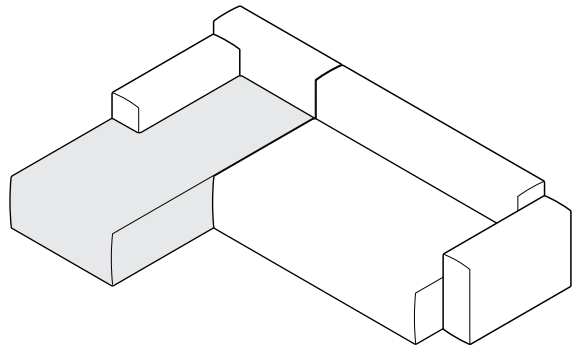

Rolled Side Soft

The option of a 'Rolled Side Soft' is offered on Double Seats, Double Full Seats, Chaise Right, and Chaise Left units capping the end of a layout. Seam direction is altered from the standard 'Rolled Front' for a consistent pattern with adjacent seats. This enables striped and patterned fabrics to line up across units.

Please refer to the sample layouts on this page as a reference for each 'Rolled Side' unit.

Selection of rolled side units will be reviewed and suggested by Stylex per customer layout. Refer to page 8 for pricing information.

Yoom Rolled Soft

Product Information Applications - Privacy Screens

Modular Lounge Systems

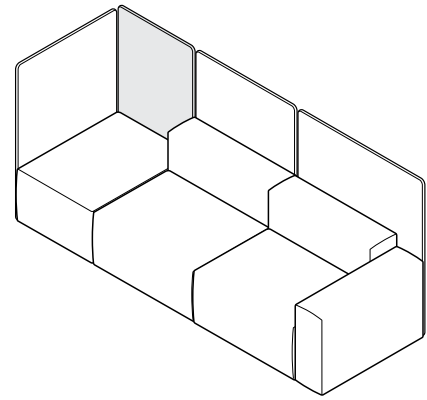

YM061 - Privacy Screen (25")

Privacy Screens

Yoom Privacy Screens are field installed and can be installed on seats, backs and arms. They can be used to provide privacy and definition to the space or can be directly used as a back with throw pillows in lieu of the traditional Yoom Backs or Back to Backs. Three different privacy screen widths have been created to keep pace with the specifiers creativity.

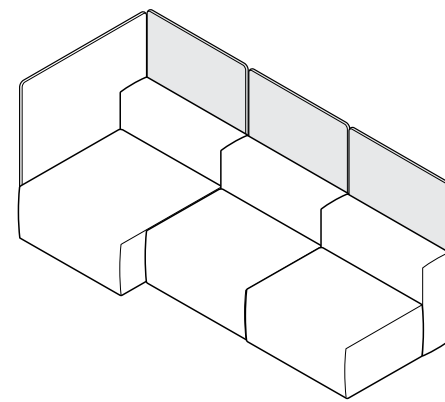
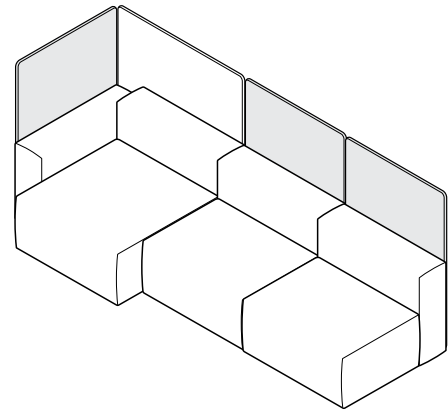
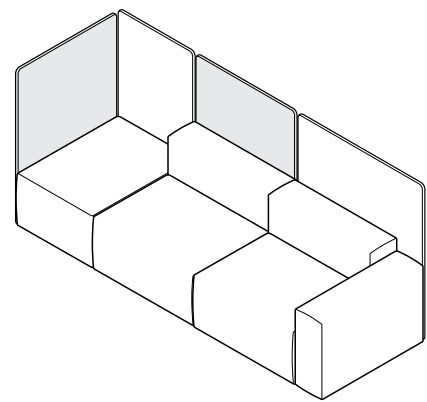

YM062 - Privacy Screens (34")

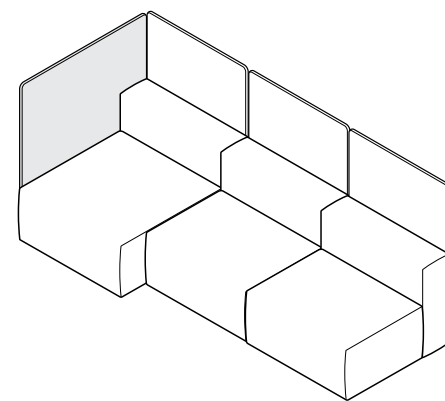
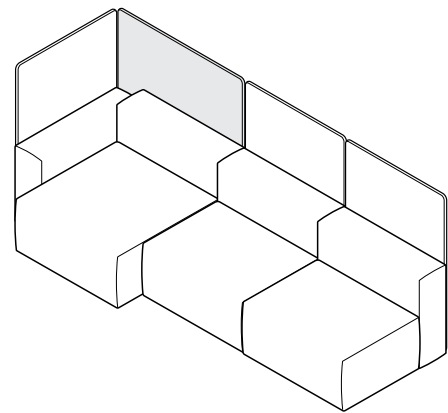
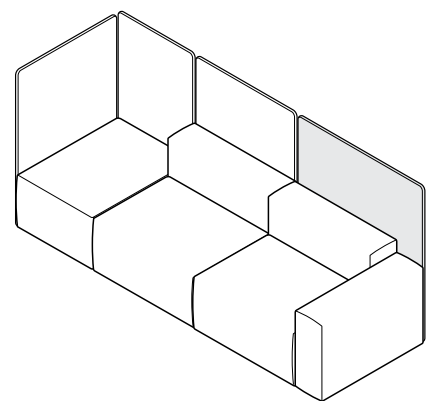

YM063 - Privacy Screens (43")

Yoom Rolled Soft - A La Carte

Single Seat

Modular Lounge Systems

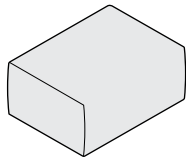
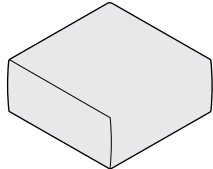
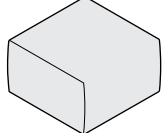
Series	Style	Type	Description	C.O.M.		C.O.L.		C.O.M. Fabric Upholstery Grades																	C.O.L. Leather Upholstery Grades	
				Ydg.	Sq.Ft.	A	B	C	D	E	F	G	H	I	J	K	L	M	W	X	Y	E1	E2			
	YM	5	11	Single Seat Rolled Front Depth 25" Height 15" Width 34"	2.5	40	1,265	1,403	1,478	1,551	1,626	1,701	1,783	1,866	1,962	2,088	2,237	2,388	2,536	2,685	2,119	2,341	3,058	3,357	4,167	
	YM	5	12	Single Full Seat Rolled Front Depth 34" Height 15" Width 34"	3.3	48	1,595	1,783	1,885	1,984	2,087	2,189	2,301	2,413	2,545	2,717	2,922	3,126	3,328	3,532	2,614	2,879	3,735	4,091	5,056	
	YM	5	13	Single Narrow Seat Rolled Front Depth 25" Height 15" Width 25"	2.0	32	1,045	1,158	1,219	1,278	1,340	1,401	1,469	1,536	1,615	1,718	1,841	1,964	2,085	2,208	1,706	1,891	2,455	2,690	3,326	

To Order follow steps 1-7

1 Series/Style	2 Type	3 Seam Option	4 Decorative Stitch Colors	5 Glides/Casters/Legs	6 Options	7 Fabrics
<p>YM5 Yoom Rolled Front Soft</p>	<p>11 Single Seat</p> <p>12 Single Full Seat</p> <p>13 Single Narrow Seat</p>	<p>Seam Option</p> <p>SS Single seam on all edges +00</p> <p>SP Pinch seam on top edges +00</p> <p>SW Single seam on side edges +10% of COM List</p> <p>SW Standard welt cord on all edges +10% of COM List</p> <p>Decorative Stitch on all edges (available on woven textiles only)</p> <p>SSD1 Blanket stitch over single seam +10% of COM List</p> <p>SSD2 Zig Zag stitch over single seam +10% of COM List</p> <p>SSD3 Bowtie stitch over single seam +10% of COM List</p> <p>Thread color must be specified. Reference Stylex/Stitching on Stylexseating.com for thread colors and stitch images.</p>	<p>Decorative Stitch Color</p> <p>01 White</p> <p>02 Natural</p> <p>03 Lemon</p> <p>04 Pebble Beige</p> <p>05 Dk Mahogany</p> <p>06 Orange</p> <p>07 Red</p> <p>08 Purple</p> <p>09 Pro Blue</p> <p>10 Navy</p> <p>11 Olive</p> <p>12 Dark Green</p> <p>13 Nickel</p> <p>14 Dark Gray</p> <p>15 Black</p>	<p>Glide Options</p> <p>PG Plastic Glide +00 Recommended for easier movement on carpet.</p> <p>FG Felt Glide +00 Recommended for easier movement on hard floors.</p> <p>RG Rubber Glides +00 Recommended for static positioning.</p> <p>Caster Options</p> <p>CH Hard Wheel Caster +65 Recommended for full mobility in collaborative settings.</p> <p>CS Soft Wheel Caster +65 Recommended for full mobility in collaborative settings.</p> <p>Round Legs +112 Legs increase seating height by 2". All standard Stylex powder paints and Polished Aluminum are available leg finish choices.</p>	<p>G Ganging +00</p> <p>C1X In-seat power port with 10' power cord +337</p> <p>C2X In-seat power port with 20' power cord +393</p> <p>W1X 12' BX whip (for hardwiring) +674</p> <p>W2X 24' BX whip (for hardwiring) +786</p> <p>See Page 6 for complete information on specifying power ports.</p>	<p>Yoom Rolled Soft fabrics must be cut up the roll.</p> <p>Yoom Rolled Soft is designed to have a casual look and feel. It is meant to show wrinkling with most fabrics and leathers.</p> <p>Refer to Stylex swatch cards and separately published in-graded fabric program to determine grades.</p> <p>See General Information section in the main price list for CAL 133 Information.</p>



Yoom Rolled Soft - A La Carte

Rolled Side - Double Seat/Chaise

Modular Lounge Systems

C.O.M.

C.O.L.

C.O.M.
Fabric Upholstery
Grades

C.O.L.

Leather Upholstery
Grades

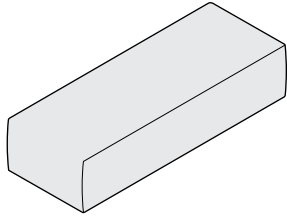
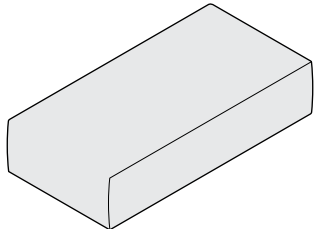
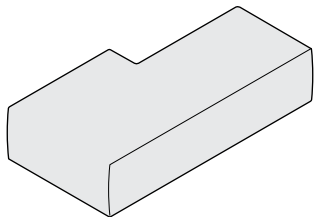
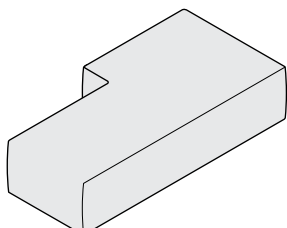
Series	Style	Type	Description	Ydg.	Sq.Ft.	C.O.M.	A	B	C	D	E	F	G	H	I	J	K	L	M	W	X	Y	E1	E2	
	YM	4	14	Double Seat Rolled Side Depth 25" Height 15" Width 68"	5.5	67	2,145	2,459	2,629	2,794	2,965	3,135	3,322	3,509	3,729	4,015	4,356	4,697	5,033	5,374	3,574	3,947	5,148	5,649	7,003
	YM	4	15	Double Full Seat Rolled Side Depth 34" Height 15" Width 68"	5.5	79	2,805	3,119	3,289	3,454	3,625	3,795	3,982	4,169	4,389	4,675	5,016	5,357	5,693	6,034	4,490	4,929	6,346	6,936	8,534
	YM	4	16	Chaise Right Rolled Side Depth 34"/25" Height 15" Width 68"	5.5	70	2,805	3,119	3,289	3,454	3,625	3,795	3,982	4,169	4,389	4,675	5,016	5,357	5,693	6,034	4,294	4,683	5,935	6,457	7,868
	YM	4	17	Chaise Left Rolled Side Depth 34"/25" Height 15" Width 68"	5.5	70	2,805	3,119	3,289	3,454	3,625	3,795	3,982	4,169	4,389	4,675	5,016	5,357	5,693	6,034	4,294	4,683	5,935	6,457	7,868

To Order follow steps 1-7

1 Series/Style 2 Type 3 Seam Option 4 Decorative Stitch Colors 5 Glides/Casters/Legs 6 Options 7 Fabrics

1 Series/Style

YM4 Yoom Rolled Side Soft

2 Type

14 Double Seat
15 Double Full Seat
16 Chaise Right
17 Chaise Left

3 Seam Option

SS Single seam on all edges +00
SP Pinch seam on top edges +00
SW Standard welt cord on all edges +10% of COM List

Decorative Stitch on all edges (available on woven textiles only)

SSD1 Blanket stitch over single seam +10% of COM List
SSD2 Zig Zag stitch over single seam +10% of COM List
SSD3 Bowtie stitch over single seam +10% of COM List

Thread color must be specified.
Reference Stylex/Stitching on Stylexseating.com for thread colors and stitch images.

4 Decorative Stitch Color

01 White
02 Natural
03 Lemon
04 Pebble Beige
05 Dk Mahogany
06 Orange
07 Red
08 Purple
09 Pro Blue
10 Navy
11 Olive
12 Dark Green
13 Nickel
14 Dark Gray
15 Black

5 Glides/Casters/Legs

PG Plastic Glide +00
Recommended for easier movement on carpet.

FG Felt Glide +00
Recommended for easier movement on hard floors.

RG Rubber Glides +00
Recommended for static positioning.

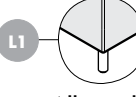
L1  **Round Legs** +112
Legs increase seating height by 2".
All standard Stylex powder paints and Polished Aluminum are available leg finish choices.

6 Options

G Ganging +00

C1X In-seat power port with 10' power cord +337

C2X In-seat power port with 20' power cord +393

W1X 12' BX whip (for hardwiring) +674

W2X 24' BX whip (for hardwiring) +786

See Page 6 for complete information on specifying power ports.

7 Fabrics

Yoom Rolled Soft fabrics must be cut up the roll.

Yoom Rolled Soft is designed to have a casual look and feel. It is meant to show wrinkling with most fabrics and leathers.

Refer to Stylex swatch cards and separately published in-graded fabric program to determine grades.

See General Information section in the main price list for CAL 133 Information.

Yoom Rolled Soft - A La Carte

Double Seat/Chaise

Modular Lounge Systems

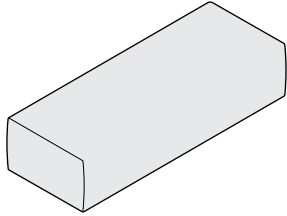
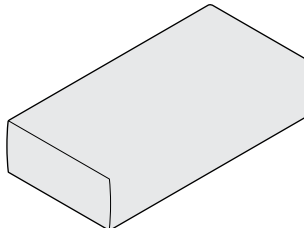
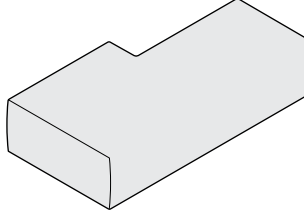
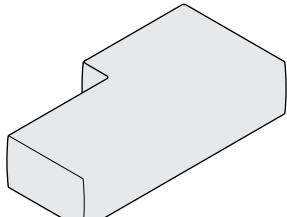
Series	Style	Type	Description	C.O.M.		C.O.L.																Leather Upholstery Grades			
				Ydg.	Sq.Ft.	A	B	C	D	E	F	G	H	I	J	K	L	M	W	X	Y	E1	E2		
	YM	5	14	Double Seat Rolled Front Depth 25" Height 15" Width 68"	4.4	67	2,145	2,389	2,522	2,651	2,784	2,917	3,064	3,209	3,380	3,604	3,870	4,136	4,398	4,663	3,574	3,947	5,148	5,649	7,003
	YM	5	15	Double Full Seat Rolled Front Depth 34" Height 15" Width 68"	5.5	79	2,805	3,112	3,279	3,441	3,608	3,775	3,959	4,142	4,357	4,638	4,972	5,306	5,635	5,969	4,490	4,929	6,346	6,936	8,534
	YM	5	16	Chaise Right Rolled Front Depth 34"/25" Height 15" Width 68"	5.0	70	2,805	3,093	3,251	3,402	3,559	3,716	3,887	4,060	4,263	4,525	4,839	5,152	5,462	5,775	4,294	4,683	5,935	6,457	7,868
	YM	5	17	Chaise Left Rolled Front Depth 34"/25" Height 15" Width 68"	5.0	70	2,805	3,093	3,251	3,402	3,559	3,716	3,887	4,060	4,263	4,525	4,839	5,152	5,462	5,775	4,294	4,683	5,935	6,457	7,868

To Order follow steps 1-7

1 Series/Style 2 Type 3 Seam Option 4 Decorative Stitch Colors 5 Glides/Casters/Legs 6 Options 7 Fabrics

1 Series/Style

YM5 Yoom Rolled Front Soft

2 Type

14 Double Seat
15 Double Full Seat
16 Chaise Right
17 Chaise Left

3 Seam Option

SS Single seam on all edges +00
SP Pinch seam on top edges +00
SW Standard welt cord on all edges +10% of COM List

Decorative Stitch on all edges (available on woven textiles only)

SSD1 Blanket stitch over single seam +10% of COM List
SSD2 Zig Zag stitch over single seam +10% of COM List
SSD3 Bowtie stitch over single seam +10% of COM List

Thread color must be specified. Reference Stylex/Stitching on Stylexseating.com for thread colors and stitch images.

4 Decorative Stitch Colors

01 White
02 Natural
03 Lemon
04 Pebble Beige
05 Dk Mahogany
06 Orange
07 Red
08 Purple
09 Pro Blue
10 Navy
11 Olive
12 Dark Green
13 Nickel
14 Dark Gray
15 Black

5 Glides/Casters/Legs

PG Plastic Glide +00
Recommended for easier movement on carpet.

FG Felt Glide +00
Recommended for easier movement on hard floors.

RG Rubber Glides +00
Recommended for static positioning.

L1 Round Legs +112
Legs increase seating height by 2".
All standard Stylex powder paints and Polished Aluminum are available leg finish choices.

6 Options

G Ganging +00

C1X In-seat power port with 10' power cord +337

C2X In-seat power port with 20' power cord +393

W1X 12' BX whip (for hardwiring) +674

W2X 24' BX whip (for hardwiring) +786

See Page 6 for complete information on specifying power ports.

7 Fabrics

Yoom Rolled Soft fabrics must be cut up the roll.

Yoom Rolled Soft is designed to have a casual look and feel. It is meant to show wrinkling with most fabrics and leathers.

Refer to Stylex swatch cards and separately published in-graded fabric program to determine grades.

See General Information section in the main price list for CAL 133 Information.

Yoom Rolled Soft - A La Carte

Single Backs

Modular Lounge Systems

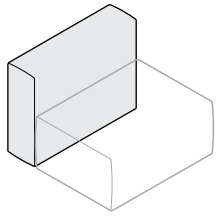
Series	Style	Type	Description	C.O.M.		C.O.L.		C.O.M. Fabric Upholstery Grades																C.O.L. Leather Upholstery Grades	
				Ydg.	Sq.Ft.	A	B	C	D	E	F	G	H	I	J	K	L	M	W	X	Y	E1	E2		
	YM	5	31	Single Back Rolled Front Depth 9" Height 26" Width 34"	2.1	33	825	944	1,009	1,071	1,136	1,201	1,273	1,343	1,427	1,536	1,665	1,795	1,923	2,052	1,519	1,700	2,283	2,526	3,183
	YM	5	32	Single High Back Rolled Front Depth 9" Height 30" Width 34"	2.3	37	908	1,040	1,111	1,180	1,252	1,323	1,401	1,481	1,573	1,693	1,836	1,979	2,121	2,264	1,692	1,896	2,555	2,829	3,573
	YM	5	33	Single Narrow Back Rolled Front Depth 9" Height 26" Width 25"	2.1	26	770	889	954	1,016	1,081	1,146	1,218	1,288	1,372	1,481	1,610	1,740	1,868	1,997	1,317	1,460	1,918	2,110	2,628
	YM	5	38	Single Narrow High Back Rolled Front Depth 9" Height 30" Width 25"	1.8	23	891	989	1,043	1,095	1,148	1,202	1,260	1,320	1,389	1,479	1,585	1,692	1,798	1,905	1,569	1,746	2,317	2,554	3,197

To Order follow steps 1-5

1 Series/Style	2 Type	3 Seam Option	4 Decorative Stitch Colors	5 Fabrics
<p>YM5</p> <p>YM5 Yoom Rolled Front Soft</p>	<p>31 Single Back</p> <p>32 Single High Back</p> <p>33 Single Narrow Back</p> <p>38 Single Narrow High Back</p>	<p>Seam Option</p> <p>SS Single seam on all edges +00</p> <p>SP Pinch seam on top edges +00</p> <p>Single seam on side edges</p> <p>SW Standard welt cord on all edges +10% of COM List</p> <p>Decorative Stitch on all edges (available on woven textiles only)</p> <p>SSD1 Blanket stitch over single seam +10% of COM List</p> <p>SSD2 Zig Zag stitch over single seam +10% of COM List</p> <p>SSD3 Bowtie stitch over single seam +10% of COM List</p> <p>Thread color must be specified.</p> <p>Reference Stylex/Stitching on Stylexseating.com for thread colors and stitch images.</p>	<p>Decorative Stitch Color</p> <p>01 White</p> <p>02 Natural</p> <p>03 Lemon</p> <p>04 Pebble Beige</p> <p>05 Dk Mahogany</p> <p>06 Orange</p> <p>07 Red</p> <p>08 Purple</p> <p>09 Pro Blue</p> <p>10 Navy</p> <p>11 Olive</p> <p>12 Dark Green</p> <p>13 Nickel</p> <p>14 Dark Gray</p> <p>15 Black</p>	<p>Yoom Rolled Soft fabrics must be cut up the roll.</p> <p>Yoom Rolled Soft is designed to have a casual look and feel. It is meant to show wrinkling with most fabrics and leathers.</p> <p>Refer to Stylex swatch cards and separately published in-graded fabric program to determine grades .</p> <p>See General Information section in the main price list for CAL 133 Information.</p>

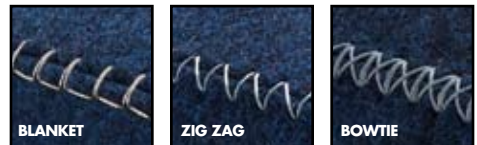

Yoom Rolled Soft - A La Carte

Single Backs

Modular Lounge Systems

Series	Style	Type	Description	Ydg.	Sq.Ft.	C.O.M. Fabric Upholstery Grades																	C.O.L. Leather Upholstery Grades		
						A	B	C	D	E	F	G	H	I	J	K	L	M	W	X	Y	E1	E2		
	YM	5	22	Single Thin Back to Back	2.1	22	918	1,035	1,098	1,160	1,224	1,287	1,358	1,427	1,509	1,616	1,743	1,871	1,996	2,122	1,702	1,906	2,565	2,839	3,582
				Rolled Front																					
	YM	5	40	Single High Thin Back to Back	2.2	24	1,026	1,149	1,216	1,281	1,348	1,415	1,488	1,562	1,648	1,760	1,894	2,028	2,160	2,294	1,810	2,014	2,673	2,947	3,690
				Rolled Front																					
	YM	5	41	Single Narrow Thin Back to Back	1.6	18	918	1,004	1,051	1,096	1,144	1,190	1,242	1,293	1,353	1,432	1,526	1,620	1,712	1,806	1,702	1,906	2,565	2,839	3,582
				Rolled Front																					
	YM	5	42	Single Narrow High Thin Back to Back	1.8	23	1,026	1,124	1,178	1,230	1,283	1,337	1,395	1,455	1,524	1,614	1,720	1,827	1,933	2,040	1,810	2,014	2,673	2,947	3,690
				Rolled Front																					

To Order follow steps 1-5

1 Series/Style 2 Type 3 Seam Option 4 Decorative Stitch Colors 5 Fabrics

1 Series/Style

- YM5 Yoom Rolled Front Soft

2 Type

- 39 Single Thin Back to Back
- 40 Single High Thin Back to Back
- 41 Single Narrow Thin Back to Back
- 42 Single Narrow High Thin Back to Back

3 Seam Option

- SS Single seam on all edges +00
- SP Pinch seam on top edges +00
- Single seam on side edges
- SW Standard welt cord on all edges +10% of COM List

Decorative Stitch on all edges (available on woven textiles only)

- SSD1 Blanket stitch over single seam +10% of COM List
- SSD2 Zig Zag stitch over single seam +10% of COM List
- SSD3 Bowtie stitch over single seam +10% of COM List

Thread color must be specified.
Reference Stylex/Stitching on Stylexseating.com for thread colors and stitch images.

4 Decorative Stitch Colors

- 01 White
- 02 Natural
- 03 Lemon
- 04 Pebble Beige
- 05 Dk Mahogany
- 06 Orange
- 07 Red
- 08 Purple
- 09 Pro Blue
- 10 Navy
- 11 Olive
- 12 Dark Green
- 13 Nickel
- 14 Dark Gray
- 15 Black

5 Fabrics

Yoom Rolled Soft fabrics must cut up the roll.

Yoom Rolled Soft is designed to have a casual look and feel. It is meant to show wrinkling with most fabrics.

Refer to Stylex swatch cards and separately published in-graded fabric program to determine grades .

See General Information section in the main price list for CAL 133 Information.



Yoom Rolled Soft - A La Carte

Double Backs

Modular Lounge Systems

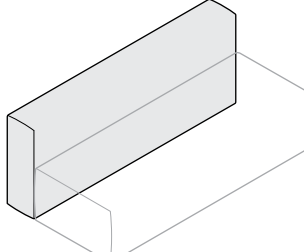
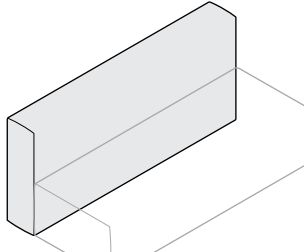
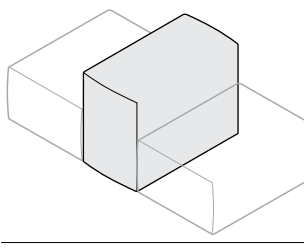
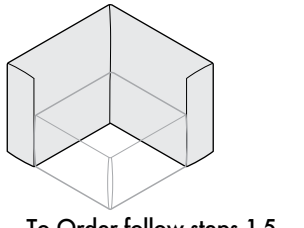
Series	Style	Type	Description	C.O.M.		C.O.L.																	Leather Upholstery Grades		
				Ydg.	Sq.Ft.	A	B	C	D	E	F	G	H	I	J	K	L	M	W	X	Y	E1	E2		
	YM	5	34	Double Back Rolled Front Depth 9" Height 26" Width 68"	4.1	57	1,540	1,772	1,899	2,021	2,146	2,273	2,411	2,550	2,713	2,924	3,176	3,429	3,677	3,929	2,760	3,078	4,102	4,529	5,685
	YM	5	35	Double High Back Rolled Front Depth 9" Height 30" Width 68"	4.7	65	1,733	1,995	2,140	2,278	2,421	2,564	2,721	2,879	3,064	3,303	3,589	3,876	4,158	4,444	3,121	3,482	4,649	5,134	6,449
	YM	5	36	Back to Back Rolled Front Depth 18" Height 26" Width 34"	3.2	38	1,045	1,227	1,326	1,421	1,520	1,619	1,728	1,836	1,964	2,130	2,328	2,526	2,720	2,917	1,844	2,052	2,723	3,002	3,759
	YM	5	37	Corner Back Rolled Front Depth 34" Height 26" Width 34"	3.3	50	1,320	1,515	1,620	1,723	1,828	1,934	2,049	2,166	2,302	2,479	2,691	2,902	3,111	3,322	2,377	2,653	3,541	3,912	4,914

To Order follow steps 1-5

1 Series/Style 2 Type 3 Seam Option 4 Decorative Stitch Colors 5 Fabrics

YM5
Yoom Rolled Front Soft

- 34 Double Back
- 35 Double High Back
- 36 Back to Back
- 37 Corner Back

- Seam Option**
- SS Single seam on all edges +00
 - SP Pinch seam on top edges +00
 - Single seam on side edges
 - SW Standard welt cord on all edges +10% of COM List



- Decorative Stitch on all edges** (available on woven textiles only)
- SSD1 Blanket stitch over single seam +10% of COM List
 - SSD2 Zig Zag stitch over single seam +10% of COM List
 - SSD3 Bowtie stitch over single seam +10% of COM List
- Thread color must be specified.
Reference Stylex/Stitching on Stylexseating.com for thread colors and stitch images.

- Decorative Stitch Color**
- 01 White
 - 02 Natural
 - 03 Lemon
 - 04 Pebble Beige
 - 05 Dk Mahogany
 - 06 Orange
 - 07 Red
 - 08 Purple
 - 09 Pro Blue
 - 10 Navy
 - 11 Olive
 - 12 Dark Green
 - 13 Nickel
 - 14 Dark Gray
 - 15 Black

Yoom Rolled Soft fabrics must be cut up the roll.

Yoom Rolled Soft is designed to have a casual look and feel. It is meant to show wrinkling with most fabrics and leathers.

Refer to Stylex swatch cards and separately published in-graded fabric program to determine grades .

See General Information section in the main price list for CAL 133 Information.

Yoom Rolled Soft - A La Carte

Arm and Privacy Screens

Modular Lounge Systems

C.O.M.

C.O.L.

C.O.M.
Fabric Upholstery
Grades

C.O.L.

Leather Upholstery
Grades

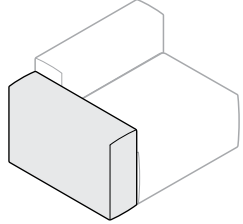
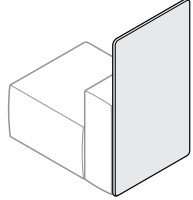
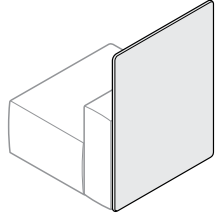
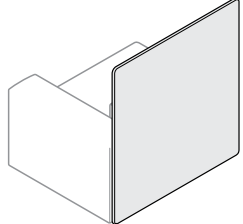
Series	Style	Type	Description	Ydg.	Sq.Ft.	C.O.M.	A	B	C	D	E	F	G	H	I	J	K	L	M	W	X	Y	E1	E2	
	YM	5	51	Single Low Arm Rolled Front Depth 9" Height 22" Width 34"	1.9	33	688	794	853	909	966	1,024	1,088	1,152	1,227	1,323	1,439	1,555	1,670	1,785	1,378	1,559	2,140	2,382	3,036
	YM	0	61	25" Privacy Screen Depth 1.5" Height 45" Width 25"	2.2		756	879	946	1,011	1,078	1,145	1,218	1,292	1,378	1,490	1,624	1,758	1,890	2,024					
	YM	0	62	34" Privacy Screen Depth 1.5" Height 45" Width 34"	3.0		972	1,138	1,229	1,316	1,406	1,497	1,596	1,695	1,812	1,963	2,144	2,325	2,503	2,684					
	YM	0	63	43" Privacy Screen Depth 1.5" Height 45" Width 43"	3.8		1,188	1,397	1,511	1,621	1,735	1,849	1,974	2,099	2,246	2,436	2,664	2,892	3,116	3,343					

To Order follow steps 1-5

1 Series/Style 2 Type 3 Seam Option 4 Decorative Stitch Colors 5 Fabrics

- YM Yoom Rolled Front Soft

- 551 Single Low Arm
- 061 25" Privacy Screen
- 062 34" Privacy Screen
- 063 43" Privacy Screen

- Seam Option**
 - SS Single seam on all edges +00
 - SP Pinch seam on top edges* +00
 - Single seam on side edges
 - SW Standard welt cord on all edges* +10% of COM List



- Decorative Stitch on all edges (available on woven textiles only)***
 - SSD1 Blanket stitch over single seam +10% of COM List
 - SSD2 Zig Zag stitch over single seam +10% of COM List
 - SSD3 Bowtie stitch over single seam +10% of COM List

Thread color must be specified.
Reference Stylex/Stitching on Stylexseating.com for thread colors and stitch images.
*Not applicable w/privacy screens.

- Decorative Stitch Color**
 - 01 White
 - 02 Natural
 - 03 Lemon
 - 04 Pebble Beige
 - 05 Dk Mahogany
 - 06 Orange
 - 07 Red
 - 08 Purple
 - 09 Pro Blue
 - 10 Navy
 - 11 Olive
 - 12 Dark Green
 - 13 Nickel
 - 14 Dark Gray
 - 15 Black

- Yoom Rolled Soft fabrics must cut up the roll.

Yoom Rolled Soft is designed to have a casual look and feel. It is meant to show wrinkling with most fabrics.

Refer to Stylex swatch cards and separately published in-graded fabric program to determine grades .

See General Information section in the main price list for CAL 133 Information.

Yoom Rolled Soft

Single Chairs

Modular Lounge Systems

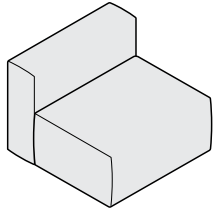
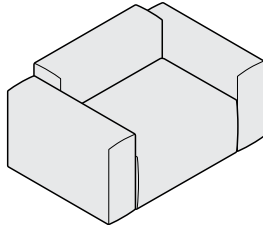
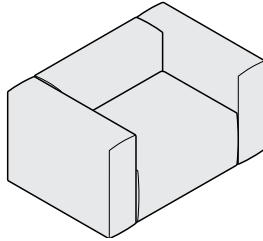
Series	Style	Type	Description	Ydg.	Sq.Ft.	C.O.M. Fabric Upholstery Grades										Leather Upholstery Grades									
						A	B	C	D	E	F	G	H	I	J	K	L	M	W	X	Y	E1	E2		
	YM	5	113100	Single Chair Armless		2,090	2,341	2,477	2,609	2,746	2,882	3,032	3,181	3,357	3,586	3,859	4,132	4,400	4,673	3,638	4,040	5,341	5,883	7,350	
				Rolled Front	4.4																				73
				Depth	34"																				
				Height	26"																				
	YM	5	113151P	Single Chair with Low Arms		3,465	3,923	4,171	4,412	4,662	4,910	5,183	5,456	5,777	6,195	6,694	7,191	7,681	8,179	6,394	7,158	9,620	10,646	13,422	
				Rolled Front	8.0																				138
				Depth	34"																				
				Height	26"																				
	YM	5	113131P	Single Chair with High Arms		3,740	4,223	4,486	4,740	5,002	5,265	5,553	5,841	6,180	6,620	7,145	7,670	8,187	8,712	6,676	7,439	9,906	10,934	13,717	
				Rolled Front	8.5																				138
				Depth	34"																				
				Height	26"																				

To Order follow steps 1-7

1 Series/Style	2 Type	3 Seam Option	4 Decorative Stitch Colors	5 Glides/Casters/Legs	6 Options	7 Fabrics
<p>YM5 Yoom Rolled Front Soft</p>	<p>113100 Single Chair Armless</p> <p>113151P Single Chair with Low Arms</p> <p>113131P Single Chair with High Arms</p>	<p>Seam Option</p> <p>SS Single seam on all edges +00</p> <p>SP Pinch seam on top edges +00</p> <p>Single seam on side edges</p> <p>SW Standard welt cord on all edges +10% of COM List</p>	<p>Decorative Stitch Color</p> <p>01 White</p> <p>02 Natural</p> <p>03 Lemon</p> <p>04 Pebble Beige</p> <p>05 Dk Mahogany</p> <p>06 Orange</p> <p>07 Red</p> <p>08 Purple</p> <p>09 Pro Blue</p> <p>10 Navy</p> <p>11 Olive</p> <p>12 Dark Green</p> <p>13 Nickel</p> <p>14 Dark Gray</p> <p>15 Black</p>	<p>Glide Options</p> <p>PG Plastic Glide +00 Recommended for easier movement on carpet.</p> <p>FG Felt Glide +00 Recommended for easier movement on hard floors.</p> <p>RG Rubber Glides +00 Recommended for static positioning.</p> <p>Caster Options</p> <p>CH Hard Wheel Caster +65 Recommended for full mobility in collaborative settings.</p> <p>CS Soft Wheel Caster +65 Recommended for full mobility in collaborative settings.</p> <p>L1 Round Legs +112 Legs increase seating height by 2". All standard Stylex powder paints and Polished Aluminum are available leg finish choices.</p>	<p>G Ganging +00</p> <p>C1X In-seat power port with 10' power cord +337</p> <p>C2X In-seat power port with 20' power cord +393</p> <p>W1X 12' BX whip (for hardwiring) +674</p> <p>W2X 24' BX whip (for hardwiring) +786</p> <p>See Page 6 for complete information on specifying power ports.</p>	<p>+00 Yoom Rolled Soft fabrics must be cut up the roll.</p> <p>Yoom Rolled Soft is designed to have a casual look and feel. It is meant to show wrinkling with most fabrics and leathers.</p> <p>Refer to Stylex swatch cards and separately published in-graded fabric program to determine grades .</p> <p>See General Information section in the main price list for CAL 133 Information.</p>



Decorative Stitch on all edges (available on woven textiles only)

SSD1 Blanket stitch over single seam +10% of COM List

SSD2 Zig Zag stitch over single seam +10% of COM List

SSD3 Bowtie stitch over single seam +10% of COM List

Thread color must be specified.
Reference Stylex/Stitching on Stylexseating.com for thread colors and stitch images.

Yoom Rolled Soft

Double Chairs

Modular Lounge Systems

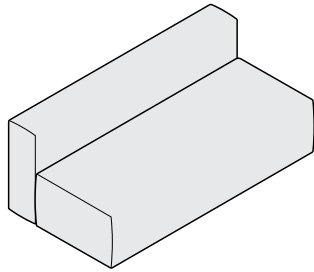
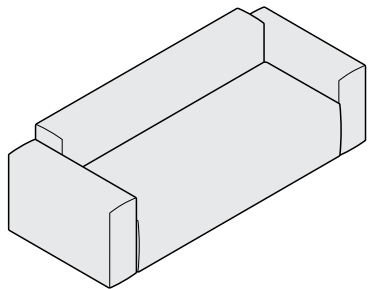
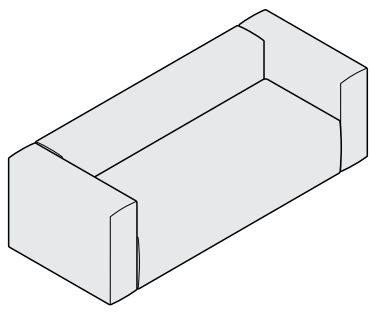
Series	Style	Type	Description	Ydg.	Sq.Ft.	C.O.M. Fabric Upholstery Grades															Leather Upholstery Grades				
						A	B	C	D	E	F	G	H	I	J	K	L	M	W	X	Y	E1	E2		
	YM	5	143400	Double Chair Armless		3,685	4,156	4,411	4,659	4,915	5,170	5,451	5,731	6,061	6,490	7,002	7,513	8,017	8,528	6,334	7,025	9,250	10,177	12,687	
				Rolled Front	8.3																				125
				Depth	34"																				
				Height	26"																				
	YM	5	143451P	Double Chair with Low Arms		5,060	5,738	6,105	6,461	6,830	7,198	7,602	8,006	8,481	9,099	9,836	10,572	11,297	12,034	9,090	10,142	13,529	14,940	18,759	
				Rolled Front	11.9																				190
				Depth	34"																				
				Height	26"																				
	YM	5	143431P	Double Chair with High Arms		5,335	6,037	6,420	6,789	7,171	7,553	7,972	8,391	8,884	9,524	10,287	11,052	11,803	12,566	9,372	10,424	13,815	15,228	19,054	
				Rolled Front	12.3																				190
				Depth	34"																				
				Height	26"																				

To Order follow steps 1-7

1 Series/Style	2 Type	3 Seam Option	4 Decorative Stitch Colors	5 Glides/Casters/Legs	6 Options	7 Fabrics
<p>YM5 Yoom Rolled Front Soft</p>	<p>143400 Double Chair Armless</p> <p>143451P Double Chair with Low Arms</p> <p>143431P Double Chair with High Arms</p>	<p>Seam Option</p> <p>SS Single seam on all edges +00</p> <p>SP Pinch seam on top edges +00</p> <p>Single seam on side edges</p> <p>SW Standard welt cord on all edges +10% of COM List</p>	<p>Decorative Stitch Color</p> <p>01 White</p> <p>02 Natural</p> <p>03 Lemon</p> <p>04 Pebble Beige</p> <p>05 Dk Mahogany</p> <p>06 Orange</p> <p>07 Red</p> <p>08 Purple</p> <p>09 Pro Blue</p> <p>10 Navy</p> <p>11 Olive</p> <p>12 Dark Green</p> <p>13 Nickel</p> <p>14 Dark Gray</p> <p>15 Black</p>	<p>Glide Options</p> <p>PG Plastic Glide +00 Recommended for easier movement on carpet.</p> <p>FG Felt Glide +00 Recommended for easier movement on hard floors.</p> <p>RG Rubber Glides +00 Recommended for static positioning.</p> <p>Round Legs +112 Legs increase seating height by 2". All standard Stylex powder paints and Polished Aluminum are available leg finish choices.</p>	<p>Ganging +00</p> <p>C1X In-seat power port with 10' power cord +337</p> <p>C2X In-seat power port with 20' power cord +393</p> <p>W1X 12' BX whip (for hardwiring) +674</p> <p>W2X 24' BX whip (for hardwiring) +786</p> <p>See Page 6 for complete information on specifying power ports.</p>	<p>Yoom Rolled Soft fabrics must be cut up the roll.</p> <p>Yoom Rolled Soft is designed to have a casual look and feel. It is meant to show wrinkling with most fabrics and leathers.</p> <p>Refer to Stylex swatch cards and separately published in-graded fabric program to determine grades.</p> <p>See General Information section in the main price list for CAL 133 Information.</p>



Decorative Stitch on all edges (available on woven textiles only)

SSD1 Blanket stitch over single seam +10% of COM List

SSD2 Zig Zag stitch over single seam +10% of COM List

SSD3 Bowtie stitch over single seam +10% of COM List

Thread color must be specified.
Reference Stylex/Stitching on Stylexseating.com for thread colors and stitch images.

Yoom Rolled Soft

Double Full Chairs

Modular Lounge Systems

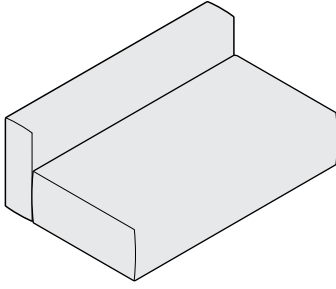
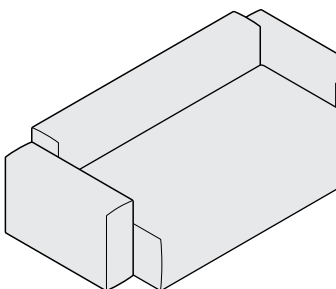
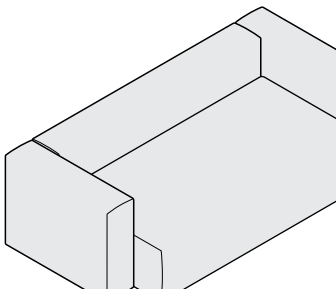
Series	Style	Type	Description	Ydg.	Sq.Ft.	C.O.M. Fabric Upholstery Grades										C.O.L.		Leather Upholstery Grades						
						A	B	C	D	E	F	G	H	I	J	K	L	M	W	X	Y	E1	E2	
	YM	5	153400	Double Full Chair Armless		4,345	4,879	5,168	5,448	5,739	6,028	6,346	6,664	7,038	7,524	8,104	8,683	9,254	9,834	7,250	8,007	10,448	11,464	14,219
				Rolled Front	9.4	137	Depth 43" Height 26" Seat Height 15" Width 68"																	
	YM	5	153451P	Double Full Chair with Low Arms		5,720	6,460	6,862	7,251	7,654	8,056	8,498	8,939	9,458	10,133	10,938	11,743	12,535	13,340	10,007	11,124	14,727	16,227	20,291
				Rolled Front	13.0	202	Depth 43" Height 26" Seat Height 15" Arm Height 22" Width 86"																	
	YM	5	153431P	Double Full Chair with High Arms		5,995	6,760	7,176	7,579	7,995	8,411	8,867	9,324	9,860	10,558	11,389	12,222	13,041	13,872	10,288	11,406	15,013	16,515	20,585
				Rolled Front	13.5	202	Depth 43" Height 26" Seat Height 15" Arm Height 26" Width 86"																	

To Order follow steps 1-7

1 Series/Style	2 Type	3 Seam Option	4 Decorative Stitch Colors	5 Glides/Casters/Legs	6 Options	7 Fabrics
<p>YM5 Yoom Rolled Front Soft</p>	<p>153400 Double Full Chair Armless</p> <p>153451P Double Full Chair with Low Arms</p> <p>153431P Double Full Chair with High Arms</p>	<p>Seam Option</p> <p>SS Single seam on all edges +00</p> <p>SP Pinch seam on top edges +00</p> <p>Single seam on side edges</p> <p>SW Standard welt cord on all edges +10% of COM List</p>	<p>Decorative Stitch Color</p> <p>01 White</p> <p>02 Natural</p> <p>03 Lemon</p> <p>04 Pebble Beige</p> <p>05 Dk Mahogany</p> <p>06 Orange</p> <p>07 Red</p> <p>08 Purple</p> <p>09 Pro Blue</p> <p>10 Navy</p> <p>11 Olive</p> <p>12 Dark Green</p> <p>13 Nickel</p> <p>14 Dark Gray</p> <p>15 Black</p>	<p>Glide Options</p> <p>PG Plastic Glide +00 Recommended for easier movement on carpet.</p> <p>FG Felt Glide +00 Recommended for easier movement on hard floors.</p> <p>RG Rubber Glides +00 Recommended for static positioning.</p> <p>Round Legs +112 Legs increase seating height by 2". All standard Stylex powder paints and Polished Aluminum are available leg finish choices.</p>	<p>Ganging +00</p> <p>C1X In-seat power port with 10' power cord +337</p> <p>C2X In-seat power port with 20' power cord +393</p> <p>W1X 12' BX whip (for hardwiring) +674</p> <p>W2X 24' BX whip (for hardwiring) +786</p> <p>See Page 6 for complete information on specifying power ports.</p>	<p>Yoom Rolled Soft fabrics must be cut up the roll.</p> <p>Yoom Rolled Soft is designed to have a casual look and feel. It is meant to show wrinkling with most fabrics and leathers.</p> <p>Refer to Stylex swatch cards and separately published in-graded fabric program to determine grades.</p> <p>See General Information section in the main price list for CAL 133 Information.</p>
		<p>Decorative Stitch on all edges (available on woven textiles only)</p> <p>SSD1 Blanket stitch over single seam +10% of COM List</p> <p>SSD2 Zig Zag stitch over single seam +10% of COM List</p> <p>SSD3 Bowtie stitch over single seam +10% of COM List</p> <p>Thread color must be specified. Reference Stylex/Stitching on Stylexseating.com for thread colors and stitch images.</p>				

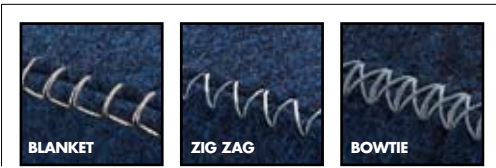

Yoom Rolled Soft

Chaise Right and Left

Modular Lounge Systems

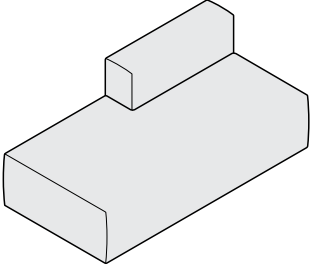
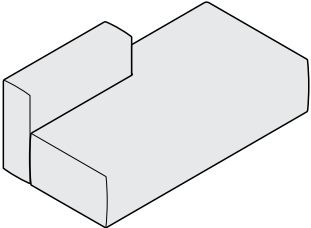
Series	Style	Type	Description	Ydg.	Sq.Ft.	Fabric Upholstery Grades										Leather Upholstery Grades									
						C.O.M.	C.O.L.	A	B	C	D	E	F	G	H	I	J	K	L	M	W	X	Y	E1	E2
	YM	5	1631	Chaise Right	7.2	103	3,630	4,038	4,259	4,474	4,696	4,917	5,160	5,403	5,689	6,061	6,504	6,948	7,384	7,828	5,814	6,382	8,217	8,983	11,052
				Rolled Front																					
	YM	5	1731	Chaise Left	7.2	103	3,630	4,038	4,259	4,474	4,696	4,917	5,160	5,403	5,689	6,061	6,504	6,948	7,384	7,828	5,814	6,382	8,217	8,983	11,052
				Rolled Front																					

To Order follow steps 1-7

1 Series/Style	2 Type	3 Seam Option	4 Decorative Stitch Colors	5 Glides/Casters/Legs	6 Options	7 Fabrics
<p>YM5 Yoom Rolled Front Soft</p>	<p>1631 Chaise Right</p> <p>1731 Chaise Left</p>	<p>Seam Option</p> <p>SS Single seam on all edges +00</p> <p>SP Pinch seam on top edges +00</p> <p>Single seam on side edges</p> <p>SW Standard welt cord on all edges +10% of COM List</p>	<p>Decorative Stitch Color</p> <p>01 White</p> <p>02 Natural</p> <p>03 Lemon</p> <p>04 Pebble Beige</p> <p>05 Dk Mahogany</p> <p>06 Orange</p> <p>07 Red</p> <p>08 Purple</p> <p>09 Pro Blue</p> <p>10 Navy</p> <p>11 Olive</p> <p>12 Dark Green</p> <p>13 Nickel</p> <p>14 Dark Gray</p> <p>15 Black</p>	<p>Glide Options</p> <p>PG Plastic Glide +00 Recommended for easier movement on carpet.</p> <p>FG Felt Glide +00 Recommended for easier movement on hard floors.</p> <p>RG Rubber Glides +00 Recommended for static positioning.</p> <p>L1 Round Legs +112 Legs increase seating height by 2". All standard Stylex powder paints and Polished Aluminum are available leg finish choices.</p>	<p>G Ganging +00</p> <p>C1X In-seat power port with 10' power cord +337</p> <p>C2X In-seat power port with 20' power cord +393</p> <p>W1X 12' BX whip (for hardwiring) +674</p> <p>W2X 24' BX whip (for hardwiring) +786</p> <p>See Page 6 for complete information on specifying power ports.</p>	<p>Yoom Rolled Soft fabrics must be cut up the roll.</p> <p>Yoom Rolled Soft is designed to have a casual look and feel. It is meant to show wrinkling with most fabrics and leathers.</p> <p>Refer to Stylex swatch cards and separately published in-graded fabric program to determine grades.</p> <p>See General Information section in the main price list for CAL 133 Information.</p>



Decorative Stitch on all edges (available on woven textiles only)

SSD1 Blanket stitch over single seam +10% of COM List

SSD2 Zig Zag stitch over single seam +10% of COM List

SSD3 Bowtie stitch over single seam +10% of COM List

Thread color must be specified.
Reference Stylex/Stitching on Stylexseating.com for thread colors and stitch images.

Yoom Rolled Soft

Corner and Narrow Chair

Modular Lounge Systems

Series	Style	Type	Description	Ydg.	Sq.Ft.	C.O.M.		C.O.L.																
						A	B	C	D	E	F	G	H	I	J	K	L	M	W	X	Y	E1	E2	
YM	6	13	Corner Chair Boxed Front Single Narrow Seat Depth 25" Height 15" Width 25"	1.7	29	1,045	1,140	1,190	1,240	1,291	1,342	1,398	1,454	1,520	1,606	1,708	1,811	1,912	2,014	1,638	1,793	2,291	2,499	3,061
	5	37	Rolled Front Corner Back Depth 34" Height 26" Width 34"	3.3	50	1,320	1,515	1,620	1,723	1,828	1,934	2,049	2,166	2,302	2,479	2,691	2,902	3,111	3,322	2,377	2,653	3,541	3,912	4,914
YM	5	1333	Narrow Chair Rolled Front Depth 25" Height 26" Seat Height 15" Width 25"	4.0	57	1,815	2,041	2,164	2,283	2,405	2,528	2,662	2,797	2,956	3,161	3,407	3,652	3,894	4,139	3,023	3,351	4,501	4,949	6,471

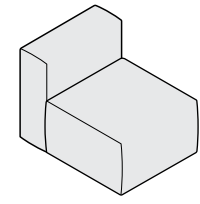
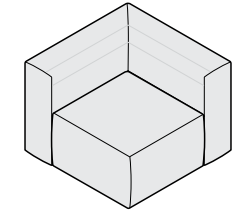

To Order follow steps 1-7

1 Series/Style	2 Type	3 Seam Option	4 Decorative Stitch Colors	5 Glides/Casters/Legs	6 Options	7 Fabrics
<p>YM5 Yoom Rolled Front Soft</p>	<p>Corner Chair YM613/YM537 <i>Note: Corner chair is ordered as two separate lines.</i></p> <p>1333 Narrow Chair YM51333</p>	<p>Seam Option</p> <p>SS Single seam on all edges +00</p> <p>SP Pinch seam on top edges +00</p> <p>Single seam on side edges</p> <p>SW Standard welt cord on all edges +10% of COM List</p>	<p>Decorative Stitch Color</p> <p>01 White</p> <p>02 Natural</p> <p>03 Lemon</p> <p>04 Pebble Beige</p> <p>05 Dk Mahogany</p> <p>06 Orange</p> <p>07 Red</p> <p>08 Purple</p> <p>09 Pro Blue</p> <p>10 Navy</p> <p>11 Olive</p> <p>12 Dark Green</p> <p>13 Nickel</p> <p>14 Dark Gray</p> <p>15 Black</p>	<p>Glide Options</p> <p>PG Plastic Glide +00 Recommended for easier movement on carpet.</p> <p>FG Felt Glide +00 Recommended for easier movement on hard floors.</p> <p>RG Rubber Glides +00 Recommended for static positioning.</p> <p>Caster Options</p> <p>CH Hard Wheel Caster +65 Recommended for full mobility in collaborative settings.</p> <p>CS Soft Wheel Caster +65 Recommended for full mobility in collaborative settings.</p> <p>Round Legs +112 Legs increase seating height by 2". All standard Stylex powder paints and Polished Aluminum are available leg finish choices.</p>	<p>G Ganging +00</p> <p>C1X In-seat power port with 10' power cord +337</p> <p>C2X In-seat power port with 20' power cord +393</p> <p>W1X 12' BX whip (for hardwiring) +674</p> <p>W2X 24' BX whip (for hardwiring) +786</p> <p>See Page 6 for complete information on specifying power ports.</p>	<p>Yoom Rolled Soft fabrics must be cut up the roll.</p> <p>Yoom Rolled Soft is designed to have a casual look and feel. It is meant to show wrinkling with most fabrics.</p> <p>Refer to Stylex swatch cards and separately published in-graded fabric program to determine grades.</p> <p>See General Information section in the main price list for CAL 133 Information.</p>



Decorative Stitch on all edges (available on woven textiles only)

SSD1 Blanket stitch over single seam +10% of COM List

SSD2 Zig Zag stitch over single seam +10% of COM List

SSD3 Bowtie stitch over single seam +10% of COM List

Thread color must be specified.
Reference Stylex/Stitching on Stylexseating.com for thread colors and stitch images.

Yoom Rolled Soft

Single Chair with Right or Left Arm

Modular Lounge Systems

C.O.M.

C.O.L.

C.O.M.
Fabric Upholstery
Grades

C.O.L.

Leather Upholstery
Grades

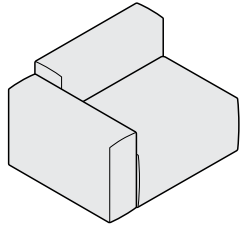
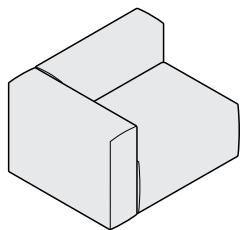
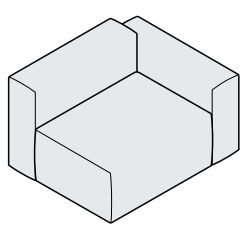
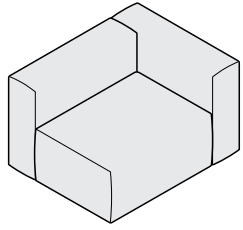
Series	Style	Type	Description	Ydg.	Sq.Ft.	C.O.M.	A	B	C	D	E	F	G	H	I	J	K	L	M	W	X	Y	E1	E2				
	YM	5	113151R	Single Chair with Right Low Arm Rolled Front Depth 34" Height 26" Seat Height 15" Arm Height 22" Width 43"	6.2	105	2,778	3,128	3,320	3,505	3,695	3,886	4,095	4,305	4,552	4,872	5,254	5,635	6,012	6,393	5,016	5,599	7,480	8,264	10,386			
		YM	5	113131R	Single Chair with Right High Arm Rolled Front Depth 34" Height 26" Seat Height 15" Arm Height 26" Width 43"	6.4	105	2,915	3,279	3,476	3,667	3,865	4,063	4,280	4,497	4,752	5,084	5,480	5,875	6,265	6,661	5,157	5,740	7,623	8,408	10,534		
			YM	5	113151L	Single Chair with Left Low Arm Rolled Front Depth 34" Height 26" Seat Height 15" Arm Height 22" Width 43"	6.2	105	2,778	3,128	3,320	3,505	3,695	3,886	4,095	4,305	4,552	4,872	5,254	5,635	6,012	6,393	5,016	5,599	7,480	8,264	10,386	
				YM	5	113131L	Single Chair with Left High Arm Rolled Front Depth 34" Height 26" Seat Height 15" Arm Height 26" Width 43"	6.4	105	2,915	3,279	3,476	3,667	3,865	4,063	4,280	4,497	4,752	5,084	5,480	5,875	6,265	6,661	5,157	5,740	7,623	8,408	10,534

To Order follow steps 1-7

1 Series/Style 2 Type 3 Seam Option 4 Decorative Stitch Colors 5 Glides/Casters/Legs 6 Options 7 Fabrics

1 Series/Style

YM5 Yoom Rolled Front Soft

2 Type

- 113151R Single Chair with Right Low Arm
- 113131R Single Chair with Right High Arm
- 113151L Single Chair with Left Low Arm
- 113131L Single Chair with Left High Arm

3 Seam Option

- SS Single seam on all edges +00
- SP Pinch seam on top edges +00
- SW Standard welt cord on all edges +10% of COM List

Decorative Stitch on all edges (available on woven textiles only)

- SSD1 Blanket stitch over single seam +10% of COM List
- SSD2 Zig Zag stitch over single seam +10% of COM List
- SSD3 Bowtie stitch over single seam +10% of COM List

Thread color must be specified. Reference Stylex/Stitching on Stylexseating.com for thread colors and stitch images.

4 Decorative Stitch Colors

- 01 White
- 02 Natural
- 03 Lemon
- 04 Pebble Beige
- 05 Dk Mahogany
- 06 Orange
- 07 Red
- 08 Purple
- 09 Pro Blue
- 10 Navy
- 11 Olive
- 12 Dark Green
- 13 Nickel
- 14 Dark Gray
- 15 Black

5 Glides/Casters/Legs

Glide Options

- PG Plastic Glide +00
Recommended for easier movement on carpet.
- FG Felt Glide +00
Recommended for easier movement on hard floors.
- RG Rubber Glides +00
Recommended for static positioning.

Caster Options

- CH Hard Wheel Caster +65
Recommended for full mobility in collaborative settings.
- CS Soft Wheel Caster +65
Recommended for full mobility in collaborative settings.

L1 Round Legs +112
Legs increase seating height by 2".
All standard Stylex powder paints and Polished Aluminum are available leg finish choices.

6 Options

- G Ganging +00
- C1X In-seat power port with 10' power cord +337
- C2X In-seat power port with 20' power cord +393
- W1X 12' BX whip (for hardwiring) +674
- W2X 24' BX whip (for hardwiring) +786

See Page 6 for complete information on specifying power ports.

7 Fabrics

Yoom Rolled Soft fabrics must be cut up the roll.

Yoom Rolled Soft is designed to have a casual look and feel. It is meant to show wrinkling with most fabrics and leathers.

Refer to Stylex swatch cards and separately published in-graded fabric program to determine grades.

See General Information section in the main price list for CAL 133 Information.

Yoom Rolled Soft

Single Full Chair with Right or Left Arm

Modular Lounge Systems

C.O.M.

C.O.L.

C.O.M.
Fabric Upholstery
Grades

C.O.L.

Leather Upholstery
Grades

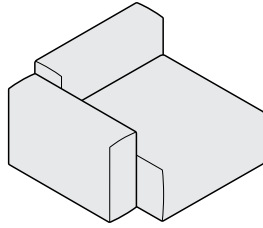
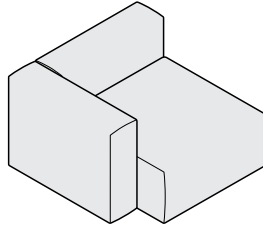
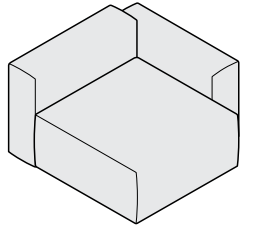
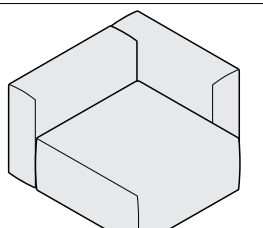
Series	Style	Type	Description	Ydg.	Sq.Ft.	C.O.M.	A	B	C	D	E	F	G	H	I	J	K	L	M	W	X	Y	E1	E2
	YM	5	123151R	Single Full Chair with Right Low Arm		3,108	3,509	3,727	3,938	4,157	4,375	4,615	4,853	5,135	5,501	5,938	6,375	6,804	7,240	5,511	6,137	8,157	8,998	11,275
				Rolled Front	7.0 113																			
				Depth	43"																			
				Height	26"																			
				Seat Height	15"																			
Arm Height	22"																							
Width	43"																							
	YM	5	123131R	Single Full Chair with Right High Arm		3,245	3,659	3,884	4,102	4,326	4,552	4,798	5,046	5,336	5,713	6,163	6,613	7,057	7,506	5,652	6,278	8,300	9,142	11,422
				Rolled Front	7.3 113																			
				Depth	43"																			
				Height	26"																			
				Seat Height	15"																			
Arm Height	26"																							
Width	43"																							
	YM	5	123151L	Single Full Chair with Left Low Arm		3,108	3,509	3,727	3,938	4,157	4,375	4,615	4,853	5,135	5,501	5,938	6,375	6,804	7,240	5,511	6,137	8,157	8,998	11,275
				Rolled Front	7.0 113																			
				Depth	43"																			
				Height	26"																			
				Seat Height	15"																			
Arm Height	22"																							
Width	43"																							
	YM	5	123131L	Single Full Chair with Left High Arm		3,245	3,659	3,884	4,102	4,326	4,552	4,798	5,046	5,336	5,713	6,163	6,613	7,057	7,506	5,652	6,278	8,300	9,142	11,422
				Rolled Front	7.3 113																			
				Depth	43"																			
				Height	26"																			
				Seat Height	15"																			
Arm Height	26"																							
Width	43"																							

To Order follow steps 1-7

1 Series/Style 2 Type 3 Seam Option 4 Decorative Stitch Colors 5 Glides/Casters/Legs 6 Options 7 Fabrics

YM5 Yoom Rolled Front Soft

123151R Single Full Chair with Right Low Arm

123131R Single Full Chair with Right High Arm

123151L Single Full Chair with Left Low Arm

123131L Single Full Chair with Left High Arm

Seam Option

SS Single seam on all edges +00

SP Pinch seam on top edges +00

SW Standard welt cord on all edges +10% of COM List

Decorative Stitch Color

01 White

02 Natural

03 Lemon

04 Pebble Beige

05 Dk Mahogany

06 Orange

07 Red

08 Purple

09 Pro Blue

10 Navy

11 Olive

12 Dark Green

13 Nickel

14 Dark Gray

15 Black

Glide Options

PG Plastic Glide +00
Recommended for easier movement on carpet.

FG Felt Glide +00
Recommended for easier movement on hard floors.

RG Rubber Glides +00
Recommended for static positioning.

Caster Options

CH Hard Wheel Caster +65
Recommended for full mobility in collaborative settings.

CS Soft Wheel Caster +65
Recommended for full mobility in collaborative settings.

L1 Round Legs +112
Legs increase seating height by 2".
All standard Stylex powder paints and Polished Aluminum are available leg finish choices.

G Ganging +00

C1X In-seat power port with 10' power cord +337

C2X In-seat power port with 20' power cord +393

W1X 12' BX whip (for hardwiring) +674

W2X 24' BX whip (for hardwiring) +786

See Page 6 for complete information on specifying power ports.

Yoom Rolled Soft fabrics must be cut up the roll.

Yoom Rolled Soft is designed to have a casual look and feel. It is meant to show wrinkling with most fabrics and leathers.

Refer to Stylex swatch cards and separately published in-graded fabric program to determine grades.

See General Information section in the main price list for CAL 133 Information.

Decorative Stitch on all edges (available on woven textiles only)

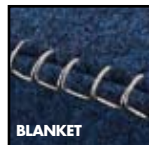

BLANKET



ZIG ZAG

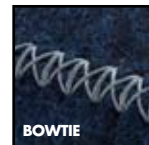

BOWTIE

SSD1 Blanket stitch over single seam +10% of COM List

SSD2 Zig Zag stitch over single seam +10% of COM List

SSD3 Bowtie stitch over single seam +10% of COM List

Thread color must be specified.
Reference Stylex/Stitching on Stylexseating.com for thread colors and stitch images.