

Prices Effective  
July 1, 2019

# STREETX

**Yoom Boxed**

**Price List**

# Yoom Boxed - A La Carte

## Product Information Applications:

Modular Lounge Systems

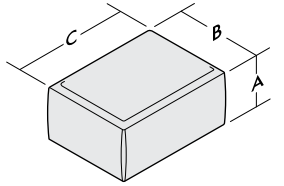
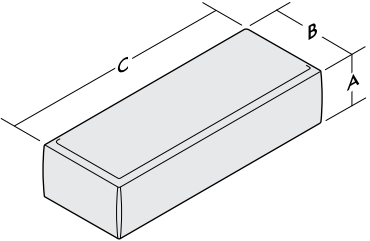
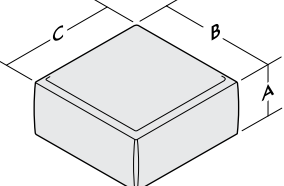
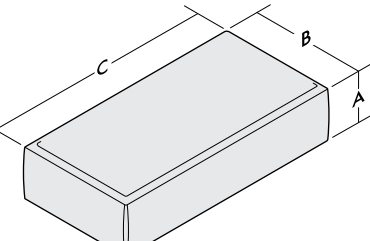
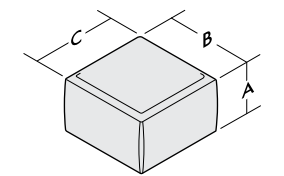
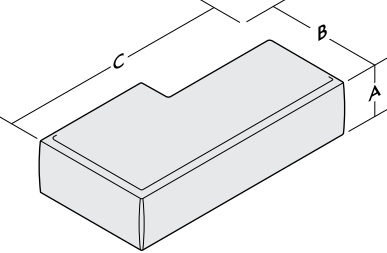
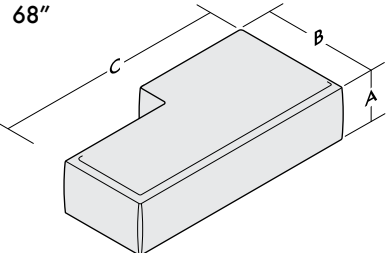
Dimensions / Overview	Single Seat	Double Seat/Chaise Seat	General Information
<p><b>General Dimensions</b> A. Height B. Depth C. Width</p>	<p><b>Single Seat</b> A. 15" B. 25" C. 34"</p> 	<p><b>Double Seat</b> A. 15" B. 25" C. 68"</p> 	<p><b>Design</b> Stylex/Anthony Land</p> <p><b>Construction</b> Internal frames are built from 5/8" PS 1-09 certified plywood. All surfaces are covered with foam of varying thicknesses and densities, depending on the particular unit. Chairs incorporate Dymetrol webbing in the seat for added comfort.</p> <p><b>Ganging</b> All individual units may be connected to one another with the use of a forked latch system.</p>
	<p><b>Single Full Seat</b> A. 15" B. 34" C. 34"</p> 	<p><b>Double Full Seat</b> A. 15" B. 34" C. 68"</p> 	<p><b>Glides</b> Yoom Boxed is available with 3 glide options: plastic, rubber, and felt.</p> <p><b>Casters</b> Yoom Boxed is available with 2 caster options: hard and soft.</p> <p><b>Power</b> Optional power receptacle offers three exposed power ports: 2 USB 2.1A ports and a standard, grounded 3-prong electrical outlet.</p> <p><b>Testing</b> Manufactured to comply with ANSI/BIFMA X5.4 Lounge Seating Tests.</p>
	<p><b>Single Narrow Seat</b> A. 15" B. 25" C. 25"</p> 	<p><b>Chaise Right</b> A. 15" B. 34" C. 68"</p> 	<p><b>Environment</b> Greenguard Certified.</p>
		<p><b>Chaise Left</b> A. 15" B. 34" C. 68"</p> 	

Please note that there is 1" of clearance between the floor and all Yoom components.

# Yoom Boxed - A La Carte

## Product Information Applications:

Modular Lounge Systems

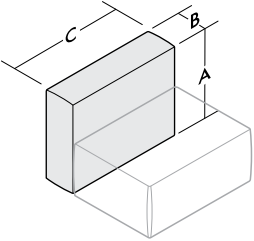
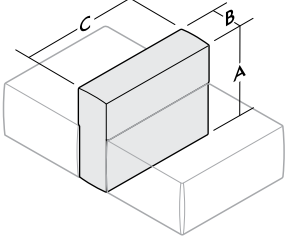
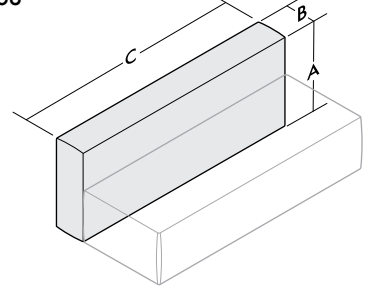
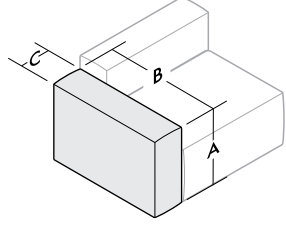
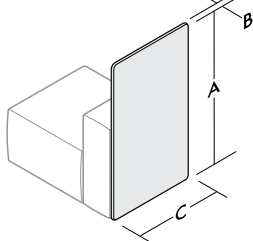
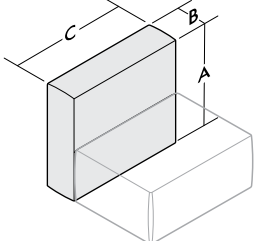
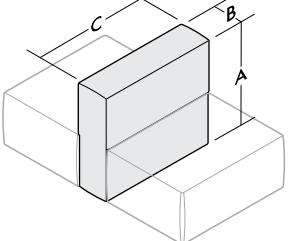
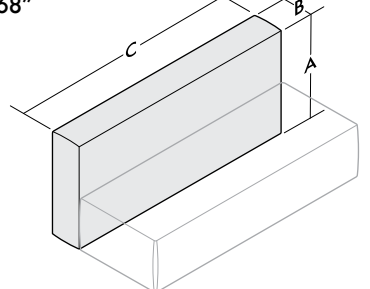
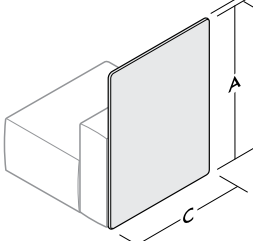
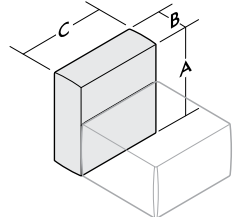
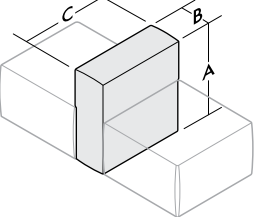
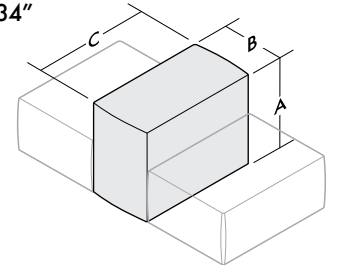
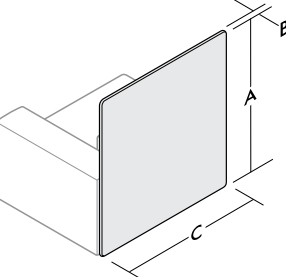
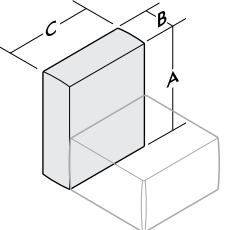
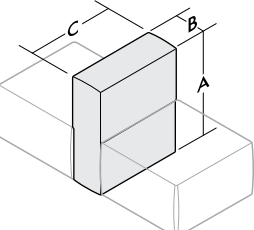
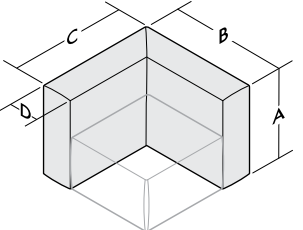
Dimensions / Overview	Single Back	Single Thin Back to Back	Double Back	Arm	Screens	General Information
<b>General Dimensions</b> A. Height B. Depth C. Width	<b>Single Back</b> A. 26" B. 9" C. 34" 	<b>Single Thin Back to Back</b> A. 26" B. 9" C. 34" 	<b>Double Back</b> A. 26" B. 9" C. 68" 	<b>Single Low Arm</b> A. 22" B. 34" C. 9" 	<b>25" Privacy Screen</b> A. 45" B. 1.5" C. 25" 	<b>Design</b> Stylex/Anthony Land <b>Construction</b> Internal frames are built from 5/8" PS 1-09 certified plywood. All surfaces are covered with foam of varying thicknesses and densities, depending on the particular unit. Chairs incorporate Dymetrol webbing in the seat for added comfort. <b>Ganging</b> All individual units may be connected to one another with the use of a forked latch system. <b>Glides</b> Yoom Boxed is available with 3 glide options: plastic, rubber, and felt. <b>Casters</b> Yoom Boxed is available with 2 caster options: hard and soft. <b>Power</b> Optional power receptacle offers three exposed power ports: 2 USB 2.1A ports and a standard, grounded 3-prong electrical outlet. <b>Testing</b> Manufactured to comply with ANSI/BIFMA X5.4 Lounge Seating Tests. <b>Environment</b> Greenguard Certified.
	<b>Single High Back</b> A. 30" B. 9" C. 34" 	<b>Single High Thin Back to Back</b> A. 30" B. 9" C. 34" 	<b>Double High Back</b> A. 30" B. 9" C. 68" 		<b>34" Privacy Screen</b> A. 45" B. 1.5" C. 34" 	
	<b>Single Narrow Back</b> A. 26" B. 9" C. 25" 	<b>Single Narrow Thin Back to Back</b> A. 26" B. 9" C. 25" 	<b>Back to Back</b> A. 26" B. 18" C. 34" 		<b>43" Privacy Screen</b> A. 45" B. 1.5" C. 43" 	
	<b>Single Narrow High Back</b> A. 30" B. 9" C. 25" 	<b>Single Narrow High Thin Back to Back</b> A. 30" B. 9" C. 25" 	<b>Corner Back</b> A. 26" B. 34" C. 34" D. 9" 			

Please note that there is 1" of clearance between the floor and all Yoom components.

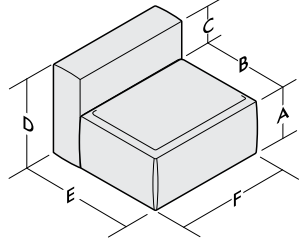
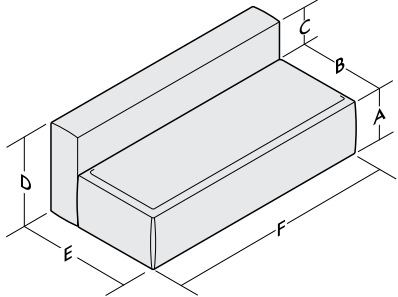
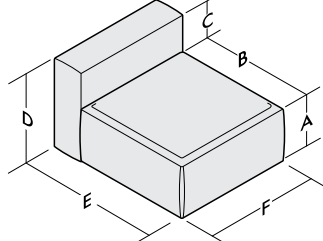
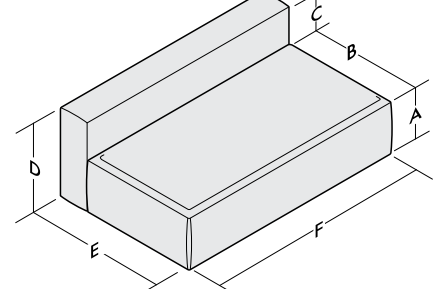
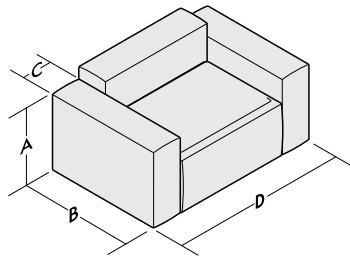
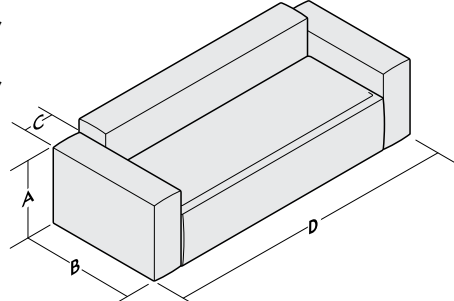
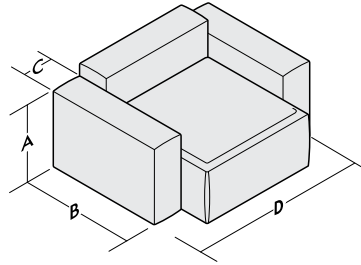
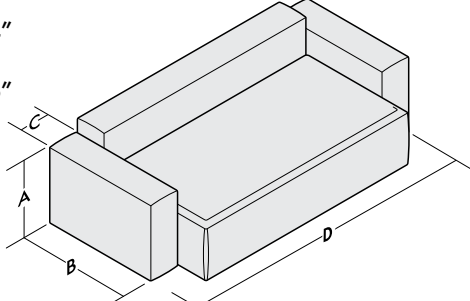
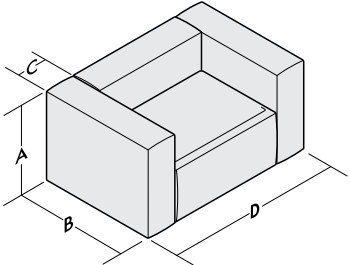
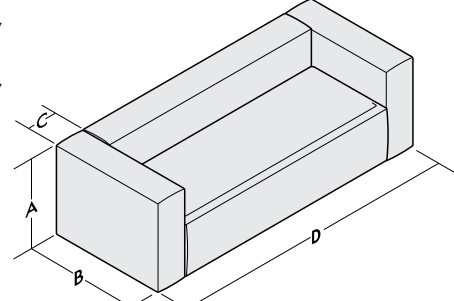
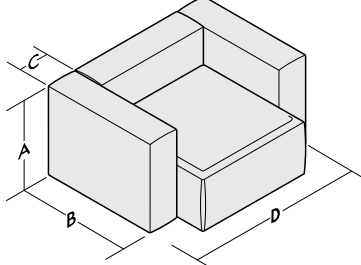
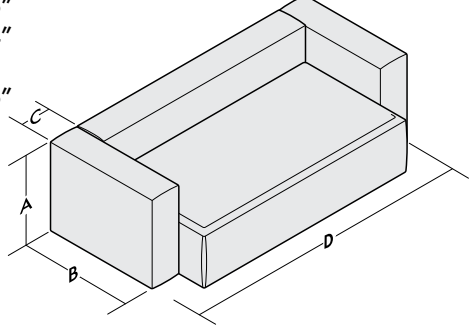
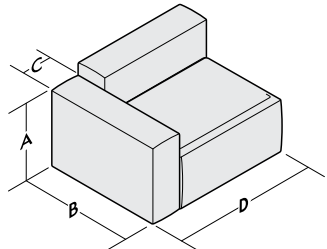
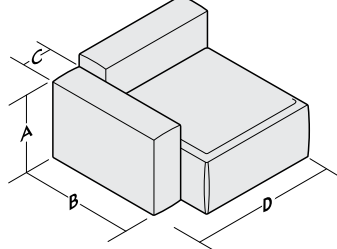
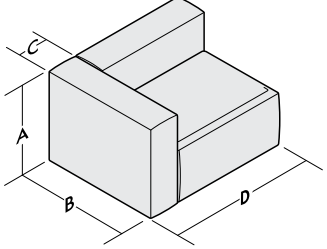
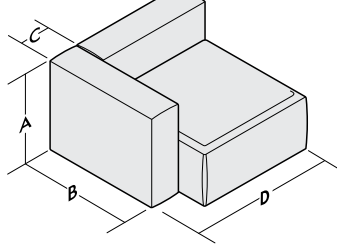
Dimensions / Overview	Single Chair	Double Chair	Single Full Chair	Double Full Chair	General Information
<b>General Dimensions</b> A. Seat Height B. Seat Depth C. Back Height D. Overall Height E. Overall Depth F. Overall Width	<b>Single Chair Armless</b> A. 15" B. 25" C. 11" D. 26" E. 34" F. 34" 	<b>Double Chair Armless</b> A. 15" B. 25" C. 11" D. 26" E. 34" F. 68" 	<b>Single Full Chair Armless</b> A. 15" B. 34" C. 11" D. 26" E. 43" F. 34" 	<b>Double Full Chair Armless</b> A. 15" B. 34" C. 11" D. 26" E. 43" F. 68" 	<b>Design</b> Stylex/Anthony Land <b>Construction</b> Internal frames are built from 5/8" PS 1-09 certified plywood. All surfaces are covered with foam of varying thicknesses and densities, depending on the particular unit. Chairs incorporate Dymetrol webbing in the seat for added comfort. <b>Ganging</b> All individual units may be connected to one another with the use of a forked latch system. <b>Glides</b> Yoom Boxed is available with 3 glide options: plastic, rubber, and felt. <b>Casters</b> Yoom Boxed is available with 2 caster options: hard and soft. <b>Power</b> Optional power receptacle offers three exposed power ports: 2 USB 2.1A ports and a standard, grounded 3-prong electrical outlet. <b>Testing</b> Manufactured to comply with ANSI/BIF-MA X5.4 Lounge Seating Tests. <b>Environment</b> Greenguard Certified.
<b>Arms Low</b> A. Height B. Depth C. Width D. Overall Width Arms	<b>Single Chair Low Arms</b> A. 22" B. 34" C. 9" D. 52" 	<b>Double Chair Low Arms</b> A. 22" B. 34" C. 9" D. 86" 	<b>Single Full Chair Low Arms</b> A. 22" B. 34" C. 9" D. 52" 	<b>Double Full Chair Low Arms</b> A. 22" B. 34" C. 9" D. 86" 	
<b>Arms High</b> A. Height B. Depth C. Width D. Overall Width Arms	<b>Single Chair High Arms</b> A. 26" B. 34" C. 9" D. 52" 	<b>Double Chair High Arms</b> A. 26" B. 34" C. 9" D. 86" 	<b>Single Full Chair High Arms</b> A. 26" B. 34" C. 9" D. 52" 	<b>Double Full Chair High Arms</b> A. 26" B. 34" C. 9" D. 86" 	
<b>Arm Low Right or Left</b> A. Height B. Depth C. Width D. Overall Width with Arm	<b>Single Chair with Right Low Arm</b> A. 22" B. 34" C. 9" D. 43" 		<b>Single Full Chair with Right Low Arm</b> A. 22" B. 34" C. 9" D. 43" 		
<b>Arm High Right or Left</b> A. Height B. Depth C. Width D. Overall Width with Arm	<b>Single Chair with Right High Arm</b> A. 26" B. 34" C. 9" D. 43" 		<b>Single Full Chair with Right High Arm</b> A. 26" B. 34" C. 9" D. 43" 		

# Yoom Boxed

## Product Information Application - Chairs



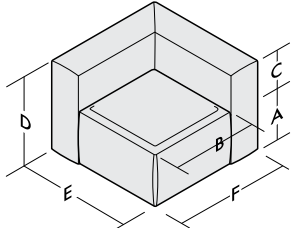
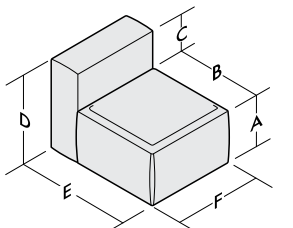
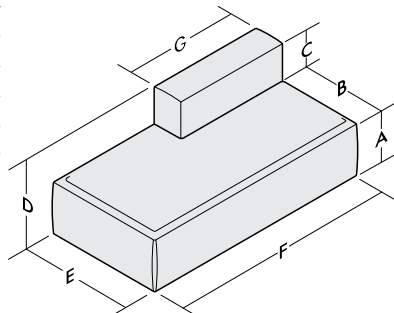
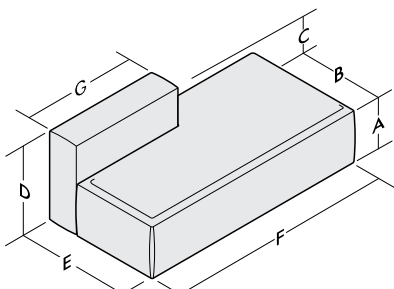





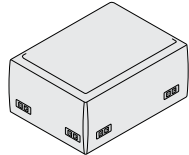

Modular Lounge Systems

Dimensions / Overview	Corner Chair	Single Narrow Chair	Chaise Right	Chaise Left	
<p><b>General Dimensions</b></p> <ul style="list-style-type: none"> <li>A. Seat Height</li> <li>B. Seat Depth</li> <li>C. Back Height</li> <li>D. Overall Height</li> <li>E. Overall Depth</li> <li>F. Overall Width</li> <li>G. Back Width</li> </ul>	<p><b>Corner Chair</b></p> <ul style="list-style-type: none"> <li>A. 15"</li> <li>B. 25"</li> <li>C. 11"</li> <li>D. 26"</li> <li>E. 34"</li> <li>F. 34"</li> </ul> 	<p><b>Single Narrow Chair</b></p> <ul style="list-style-type: none"> <li>A. 15"</li> <li>B. 25"</li> <li>C. 11"</li> <li>D. 26"</li> <li>E. 34"</li> <li>F. 25"</li> </ul> 	<p><b>Chaise Right</b></p> <ul style="list-style-type: none"> <li>A. 15"</li> <li>B. 25"</li> <li>C. 11"</li> <li>D. 26"</li> <li>E. 34"</li> <li>F. 68"</li> <li>G. 34"</li> </ul> 	<p><b>Chaise Left</b></p> <ul style="list-style-type: none"> <li>A. 15"</li> <li>B. 25"</li> <li>C. 11"</li> <li>D. 26"</li> <li>E. 34"</li> <li>F. 68"</li> <li>G. 34"</li> </ul> 	<p><b>Design</b> Stylex/Anthony Land</p> <p><b>Construction</b> Internal frames are built from 5/8" PS 1-09 certified plywood. All surfaces are covered with foam of varying thicknesses and densities, depending on the particular unit. Chairs incorporate Dymetrol webbing in the seat for added comfort.</p> <p><b>Ganging</b> All individual units may be connected to one another with the use of a forked latch system.</p> <p><b>Glides</b> Yoom Boxed is available with 3 glide options: plastic, rubber, and felt.</p> <p><b>Casters</b> Yoom Boxed is available with 2 caster options: hard and soft.</p> <p><b>Power</b> Optional power receptacle offers three exposed power ports: 2 USB 2.1A ports and a standard, grounded 3-prong electrical outlet.</p> <p><b>Testing</b> Manufactured to comply with ANSI/BIF-MA X5.4 Lounge Seating Tests.</p> <p><b>Environment</b> Greenguard Certified.</p>

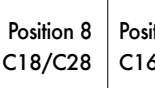
# Yoom Boxed

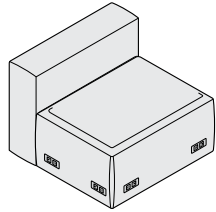
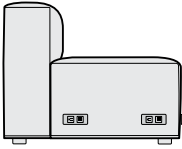
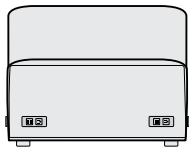
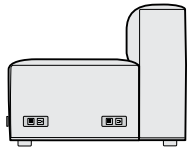
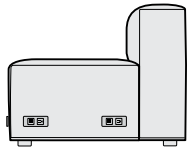
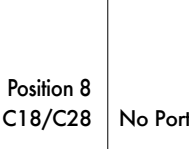
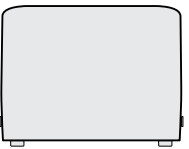
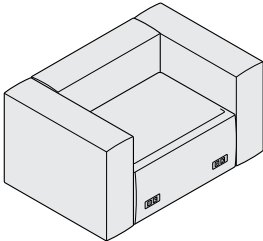
## Boxed - Power Port Options

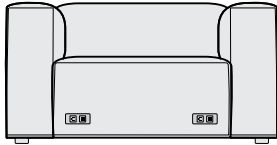
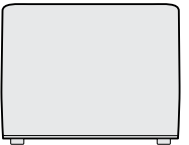
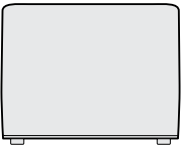
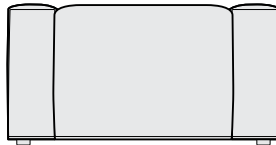
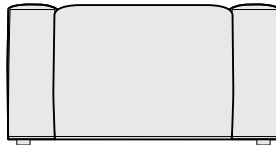
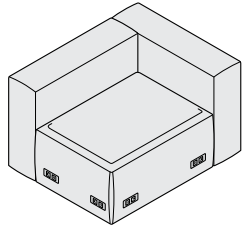
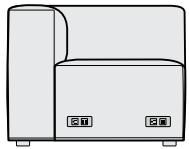
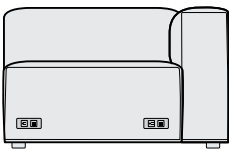
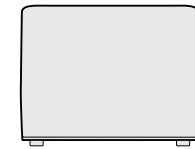
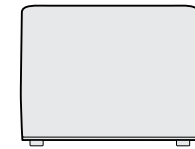
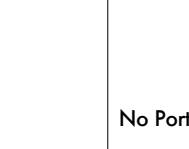
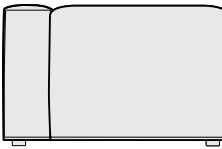
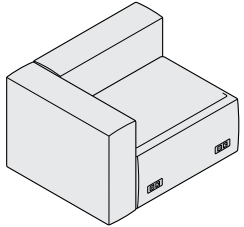
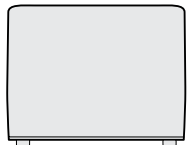
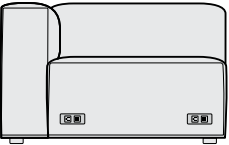
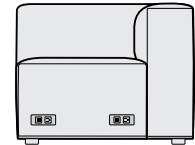
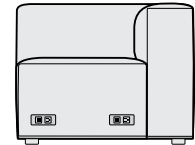
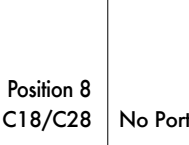
Modular Lounge Systems

	Right Side	Front	Left Side	Back	General Information				
<b>Single Seat Power Port Option(s)</b>	 Position 5 C15/C25	 Position 4 C14/C24	 Position 3 C13/C23	 Position 2 C12/C22	 Position 1 C11/C21	 Position 8 C18/C28	 Position 6 C16/C26	 Position 7 C17/C27	<p><b>In-Seat Power Ports With 10' Or 20' Cord</b></p> <p><b>Power Port Cord Length and Harness End</b> C1X has a 10' power cord w/ NEMA 5-15P C2X has a 20' Power cord w/ NEMA 5-15P W1X 12' BX whip (for hardwiring) W1X 24' BX whip (for hardwiring)</p> <p><b>Power Port Location</b> The power port location is determined by its last digit.</p> <p>Examples:</p> <ul style="list-style-type: none"> <li>A C14 power port has a 10' power cord and is located on the right side of a chair, as determined from a seated position, or the right forward position of a bench.</li> <li>A C21 power port has a 20' power cord and is located on the left side of a chair, as determined from a seated position, or the left forward position of a bench.</li> </ul> <p><b>Multiple power ports may be ordered per unit. The pricing shown is for each power port ordered.</b></p>
<b>Single Chair Power Port Option(s)</b>	 Position 5 C15/C25	 Position 4 C14/C24	 Position 3 C13/C23	 Position 2 C12/C22	 Position 1 C11/C21	 Position 8 C18/C28	No Ports		
<b>Chair w/Arms Power Port Option(s)</b>	 No Ports	 No Ports	 Position 3 C13/C23	 Position 2 C12/C22	 No Ports	 No Ports	 No Ports		
<b>Single Chair w/Left Arm Power Port Option(s)</b>	 Position 5 C15/C25	 Position 4 C14/C24	 Position 3 C13/C23	 Position 2 C12/C22	 No Ports	 No Ports	 No Ports		
<b>Single Chair w/Right Arm Power Port Option(s)</b>	 No Ports	 No Ports	 Position 3 C13/C23	 Position 2 C12/C22	 Position 1 C11/C21	 Position 8 C18/C28	 No Ports		

### Power Port Ordering

### Options-Power Port Configuration

**Length and Harness End**  
C1X 10' cord length w/ NEMA 5-15P  
C2X 20' cord length w/ NEMA 5-15P  
W1X 12' BX whip (for hardwiring)  
W1X 24' BX whip (for hardwiring)

**Option Power Port Position**  
Position 1 thru 8  
See above for power port location restrictions.

**Option Power Port Finish**

BM Black Matte	GR Green	OR Orange
BT Black Twilight	LB Light Bronze	RD Red
BL Blue	LG Light Gray	ST Sterling
BR Brass	MF Metallic Fieldstone	TP Taupe
CP Champagne	MS Metallic Silver	TS Textured Slate
DB Dark Bronze	MK Milk	TI Titanium
DC Dark Chocolate	NK Nickel	YL Yellow

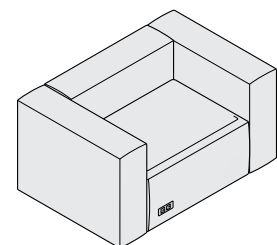

Example: C2 3 BM

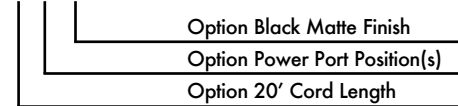

Option Black Matte Finish  
Option Power Port Position(s)  
Option 20' Cord Length

# Yoom Boxed

## Product Information Applications - Privacy Screens

Modular Lounge Systems

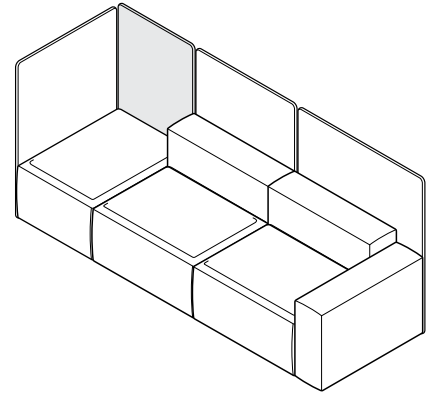

**YM061 - Privacy Screen (25")**

### Privacy Screens

Yoom Privacy Screens are field installed and can be installed on seats, backs and arms. They can be used to provide privacy and definition to the space or can be directly used as a back with throw pillows in lieu of the traditional Yoom Backs or Back to Backs. Three different privacy screen widths have been created to keep pace with the specifiers creativity.

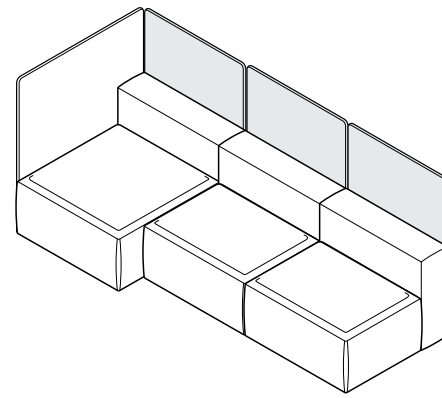
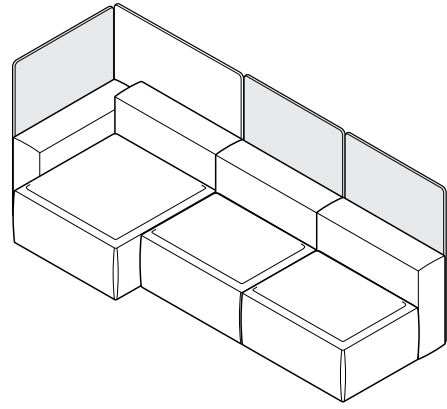
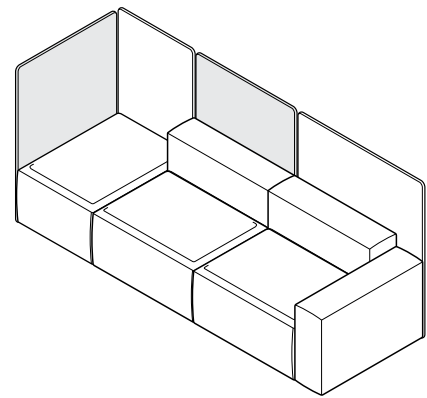

**YM062 - Privacy Screens (34")**

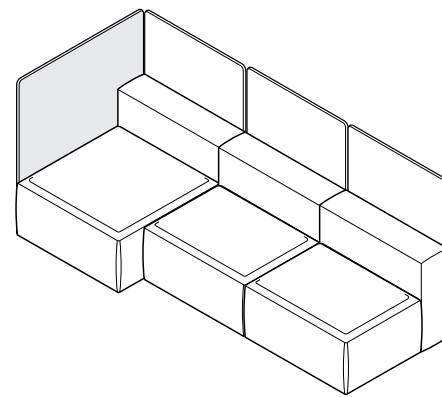
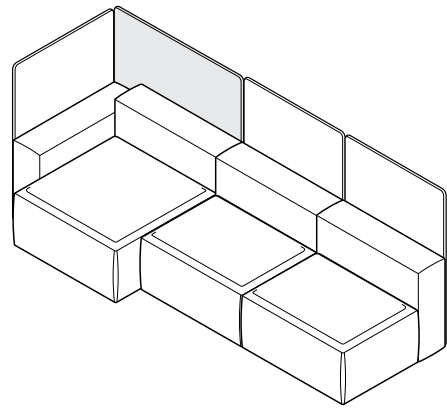
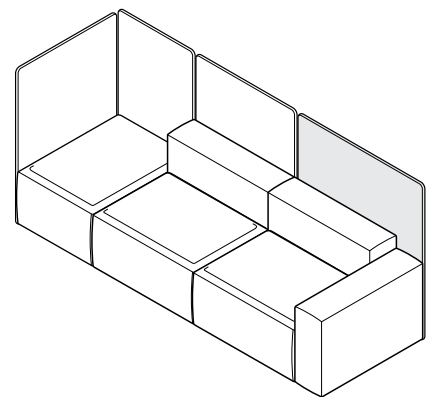

**YM063 - Privacy Screens (43")**

# Yoom Boxed - A La Carte

## Single Seat

Modular Lounge Systems

C.O.M.

C.O.M.  
Fabric Upholstery  
Grades

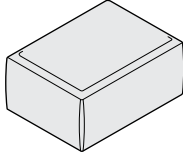
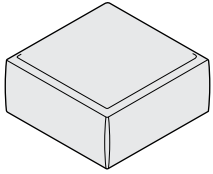
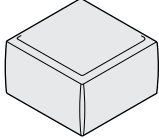
Series	Style	Type	Description	Ydg.	C.O.M.	A	B	C	D	E	F	G	H	I	J	K	L	M		
	YM	9	11	<b>Single Seat</b> Boxed Front Depth 25" Height 15" Width 34"	2.5	36	1,202	1,352	1,433	1,513	1,594	1,676	1,765	1,855	1,960	2,098	2,261	2,423	2,585	2,748
	YM	9	12	<b>Single Full Seat</b> Boxed Front Depth 34" Height 15" Width 34"	3.3		1,431	1,627	1,733	1,836	1,943	2,049	2,166	2,283	2,420	2,599	2,811	3,024	3,234	3,447
	YM	9	13	<b>Single Narrow Seat</b> Boxed Front Depth 25" Height 15" Width 25"	1.7		973	1,072	1,125	1,176	1,230	1,283	1,341	1,399	1,468	1,557	1,663	1,770	1,875	1,981

To Order follow steps 1-7

1 Series/Style	2 Type	3 Seam Option	4 Decorative Stitch Colors	5 Glides/Casters/Legs	6 Options	7 Fabrics
<p>YM9 Yoom Boxed Front</p>	<p>11 Single Seat</p> <p>12 Single Full Seat</p> <p>13 Single Narrow Seat</p>	<p><b>Seam Option</b></p> <p>SS Single seam on all edges +00</p> <p>SP Pinch seam on top edges Single seam on side edges +00</p> <p>SW Standard welt cord on all edges +10% of COM List</p> <p><b>Decorative Stitch on top edges (available on woven textiles only)</b></p> <p>SSD1 Basket stitch over single seam +10% of COM List</p> <p>SSD2 Zig Zag stitch over single seam +10% of COM List</p> <p>SSD3 Bowtie stitch over single seam +10% of COM List</p> <p>Thread color must be specified. Reference Stylex/Stitching on <a href="http://Stylexseating.com">Stylexseating.com</a> for thread colors and stitch images.</p>	<p><b>Decorative Stitch Color</b></p> <p>01 White</p> <p>02 Natural</p> <p>03 Lemon</p> <p>04 Pebble Beige</p> <p>05 Dk Mahogany</p> <p>06 Orange</p> <p>07 Red</p> <p>08 Purple</p> <p>09 Pro Blue</p> <p>10 Navy</p> <p>11 Olive</p> <p>12 Dark Green</p> <p>13 Nickel</p> <p>14 Dark Gray</p> <p>15 Black</p>	<p><b>Glide Options</b></p> <p>PG Plastic Glide +00 Recommended for easier movement on carpet.</p> <p>FG Felt Glide +00 Recommended for easier movement on hard floors.</p> <p>RG Rubber Glides +00 Recommended for static positioning.</p> <p><b>Caster Options</b></p> <p>CH Hard Wheel Caster +69 Recommended for full mobility in collaborative settings.</p> <p>CS Soft Wheel Caster +69 Recommended for full mobility in collaborative settings.</p> <p><b>Round Legs</b> +119 Legs increase seating height by 2". All standard Stylex powder paints and Polished Aluminum are available leg finish choices.</p>	<p><b>G Ganging</b> +00</p> <p><b>C1X In-seat power port with 10' power cord</b> +357</p> <p><b>C2X In-seat power port with 20' power cord</b> +417</p> <p><b>W1X 12' BX whip (for hardwiring)</b> +714</p> <p><b>W2X 24' BX whip (for hardwiring)</b> +833</p> <p>See Page 6 for complete information on specifying power ports.</p>	<p><b>Yoom Boxed is designed to have a casual look and feel. It is meant to show wrinkling with most fabrics.</b></p> <p>Refer to Stylex swatch cards and separately published in-graded fabric program to determine grades.</p> <p>See General Information section in the main price list for CAL 133 Information.</p>





# Yoom Boxed - A La Carte

## Double Seat

Modular Lounge Systems

C.O.M.

C.O.M.  
Fabric Upholstery  
Grades

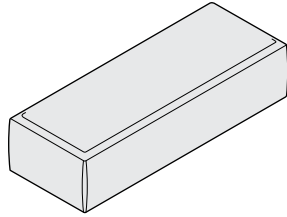
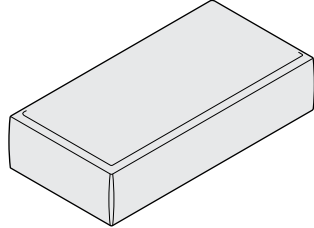
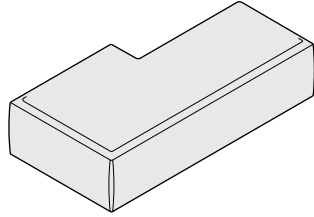
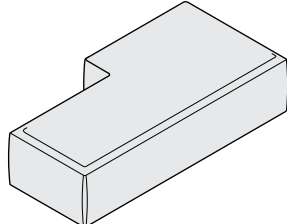
Series	Style	Type	Description	Ydg.	C.O.M.	A	B	C	D	E	F	G	H	I	J	K	L	M	
	YM	9	14	<b>Double Seat</b> Boxed Front Depth 25" Height 15" Width 68"	4.4	2,003	2,264	2,406	2,544	2,686	2,828	2,983	3,139	3,322	3,561	3,845	4,128	4,407	4,692
	YM	9	15	<b>Double Full Seat</b> Boxed Front Depth 34" Height 15" Width 68"	5.5	2,461	2,788	2,965	3,137	3,315	3,492	3,687	3,881	4,110	4,407	4,763	5,118	5,466	5,822
	YM	9	16	<b>Chaise Right</b> Boxed Front Depth 34"/25" Height 15" Width 68"	5.2	2,461	2,768	2,935	3,096	3,263	3,430	3,612	3,796	4,011	4,291	4,624	4,958	5,286	5,620
	YM	9	17	<b>Chaise Left</b> Boxed Front Depth 34"/25" Height 15" Width 68"	5.2	2,461	2,768	2,935	3,096	3,263	3,430	3,612	3,796	4,011	4,291	4,624	4,958	5,286	5,620

To Order follow steps 1-7

1 Series/Style	2 Type	3 Seam Option	4 Decorative Stitch Colors	5 Glides/Casters/Legs	6 Options	7 Fabrics
----------------	--------	---------------	----------------------------	-----------------------	-----------	-----------

<p><b>YM9</b> Yoom Boxed Front</p>	<p><b>14</b> Double Seat</p> <p><b>15</b> Double Full Seat</p> <p><b>16</b> Chaise Right</p> <p><b>17</b> Chaise Left</p>	<p><b>Seam Option</b></p> <p>SS Single seam on all edges +00</p> <p>SP Pinch seam on top edges Single seam on side edges +00</p> <p>SW Standard welt cord on all edges +10% of COM List</p> <p><b>Decorative Stitch on top edges (available on woven textiles only)</b></p> <p>SSD1 Basket stitch over single seam +10% of COM List</p> <p>SSD2 Zig Zag stitch over single seam +10% of COM List</p> <p>SSD3 Bowtie stitch over single seam +10% of COM List</p> <p>Thread color must be specified. Reference Stylex/Stitching on <a href="http://Stylexseating.com">Stylexseating.com</a> for thread colors and stitch images.</p>	<p><b>Decorative Stitch Color</b></p> <p>01 White</p> <p>02 Natural</p> <p>03 Lemon</p> <p>04 Pebble Beige</p> <p>05 Dk Mahogany</p> <p>06 Orange</p> <p>07 Red</p> <p>08 Purple</p> <p>09 Pro Blue</p> <p>10 Navy</p> <p>11 Olive</p> <p>12 Dark Green</p> <p>13 Nickel</p> <p>14 Dark Gray</p> <p>15 Black</p>	<p><b>Glide Options</b></p> <p>PG Plastic Glide +00 Recommended for easier movement on carpet.</p> <p>FG Felt Glide +00 Recommended for easier movement on hard floors.</p> <p>RG Rubber Glides +00 Recommended for static positioning.</p> <p><b>L1 Round Legs</b> +119 Legs increase seating height by 2". All standard Stylex powder paints and Polished Aluminum are available leg finish choices.</p>	<p><b>G</b> Ganging +00</p> <p><b>C1X</b> In-seat power port with 10' power cord +357</p> <p><b>C2X</b> In-seat power port with 20' power cord +417</p> <p><b>W1X</b> 12' BX whip (for hardwiring) +714</p> <p><b>W2X</b> 24' BX whip (for hardwiring) +833</p> <p>See Page 6 for complete information on specifying power ports.</p>	<p><b>Yoom Boxed is designed to have a casual look and feel. It is meant to show wrinkling with most fabrics.</b></p> <p>Refer to Stylex swatch cards and separately published in-graded fabric program to determine grades.</p> <p>See General Information section in the main price list for CAL 133 Information.</p>
------------------------------------	---	---	--	--	---	---

# Yoom Boxed - A La Carte

## Single Back

Modular Lounge Systems

C.O.M.

C.O.M.  
Fabric Upholstery  
Grades

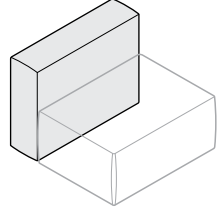
Series	Style	Type	Description	Ydg.	C.O.M.	A	B	C	D	E	F	G	H	I	J	K	L	M
	YM	9	<b>Single Back</b> Boxed Front Depth 9" Height 26" Width 34"	2.2 29	687	817	888	957	1,028	1,099	1,177	1,255	1,346	1,465	1,607	1,749	1,889	2,031
	YM	9	<b>Single High Back</b> Boxed Front Depth 9" Height 30" Width 34"	2.5	744	887	967	1,042	1,119	1,198	139	1,370	1,470	1,601	1,756	1,913	2,066	2,222
	YM	9	<b>Single Narrow Back</b> Boxed Front Depth 9" Height 26" Width 25"	1.7	630	727	781	832	885	939	997	1,056	1,125	1,214	1,320	1,427	1,532	1,638
	YM	9	<b>Single Narrow High Back</b> Boxed Front Depth 9" Height 30" Width 25"	1.9	744	848	905	960	1,017	1,074	1,136	1,199	1,272	1,367	1,481	1,594	1,706	1,819

To Order follow steps 1-5

### 1 Series/Style      2 Type      3 Seam Option      4 Decorative Stitch Colors      5 Fabrics

YM9

YM9 Yoom Boxed Front

31

31 Single Back

32

32 Single High Back

33

33 Single Narrow Back

38

38 Single Narrow High Back

Seam Option

SS Single seam on all edges +00

SP Pinch seam on top edges  
Single seam on side edges +00

SW Standard welt cord on all edges +10% of COM List

Decorative Stitch on top edges (available on woven textiles only)

SSD1 Basket stitch over single seam +10% of COM List  
SSD2 Zig Zag stitch over single seam +10% of COM List  
SSD3 Bowtie stitch over single seam +10% of COM List

Thread color must be specified.  
Reference Stylex/Stitching on [Stylexseating.com](http://Stylexseating.com) for thread colors and stitch images.



Decorative Stitch Color

01 White

02 Natural

03 Lemon

04 Pebble Beige

05 Dk Mahogany

06 Orange

07 Red

08 Purple

09 Pro Blue

10 Navy

11 Olive

12 Dark Green

13 Nickel

14 Dark Gray

15 Black

Yoom Boxed is designed to have a casual look and feel. It is meant to show wrinkling with most fabrics.

Refer to Stylex swatch cards and separately published in-graded fabric program to determine grades.

See General Information section in the main price list for CAL 133 Information.

# Yoom Boxed - A La Carte

## Backs

Modular Lounge Systems

C.O.M.

C.O.M.  
Fabric Upholstery  
Grades

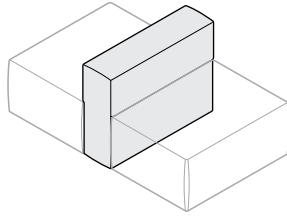
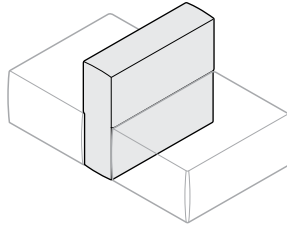
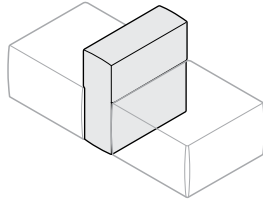
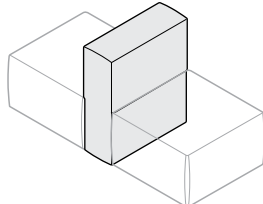
Series	Style	Type	Description	Ydg.	C.O.M.	A	B	C	D	E	F	G	H	I	J	K	L	M	
	YM	9	39	<b>Single Thin Back to Back</b> Boxed Front Depth 9" Height 26" Width 34"	2.1	801	925	993	1,058	1,126	1,193	1,267	1,341	1,428	1,541	1,676	1,810	1,943	2,079
	YM	9	40	<b>Single High Thin Back to Back</b> Boxed Front Depth 9" Height 30" Width 34"	2.2	916	1,046	1,117	1,186	1,257	1,328	1,406	1,484	1,575	1,694	1,836	1,978	2,118	2,260
	YM	9	41	<b>Single Narrow Thin Back to Back</b> Boxed Front Depth 9" Height 26" Width 25"	1.6	801	893	942	990	1,040	1,090	1,145	1,199	1,262	1,346	1,446	1,545	1,643	1,743
	YM	9	42	<b>Single Narrow High Thin Back to Back</b> Boxed Front Depth 9" Height 30" Width 25"	1.8	916	1,007	1,057	1,105	1,154	1,204	1,259	1,313	1,377	1,461	1,560	1,660	1,757	1,857

To Order follow steps 1-5

1 Series/Style	2 Type	3 Seam Option	4 Decorative Stitch Colors	5 Fabrics
<p>YM9</p> <p>YM9 Yoom Boxed Front</p>	<p>39 Single Thin Back to Back</p> <p>40 Single High Thin Back to Back</p> <p>41 Single Narrow Thin Back to Back</p> <p>42 Single Narrow High Thin Back to Back</p>	<p>Seam Option</p> <p>SS Single seam on all edges +00</p> <p>SP Pinch seam on top edges +00</p> <p>Single seam on side edges</p> <p>SW Standard welt cord on all edges +10% of COM List</p> <p>Decorative Stitch on all edges (available on woven textiles only)</p> <p>SSD1 Basket stitch over single seam +10% of COM List</p> <p>SSD2 Zig Zag stitch over single seam +10% of COM List</p> <p>SSD3 Bowtie stitch over single seam +10% of COM List</p> <p>Thread color must be specified.</p> <p>Reference Stylex/Stitching on <a href="http://Stylexseating.com">Stylexseating.com</a> for thread colors and stitch images.</p>	<p>Decorative Stitch Color</p> <p>01 White</p> <p>02 Natural</p> <p>03 Lemon</p> <p>04 Pebble Beige</p> <p>05 Dk Mahogany</p> <p>06 Orange</p> <p>07 Red</p> <p>08 Purple</p> <p>09 Pro Blue</p> <p>10 Navy</p> <p>11 Olive</p> <p>12 Dark Green</p> <p>13 Nickel</p> <p>14 Dark Gray</p> <p>15 Black</p>	<p>Yoom Rolled fabrics must be cut up the roll.</p> <p><b>Yoom Boxed is designed to have a casual look and feel. It is meant to show wrinkling with most fabrics.</b></p> <p>Refer to Stylex swatch cards and separately published in-graded fabric program to determine grades .</p> <p>See General Information section in the main price list for CAL 133 Information.</p>



# Yoom Boxed - A La Carte

## Double Back

Modular Lounge Systems

C.O.M.

C.O.M.  
Fabric Upholstery  
Grades

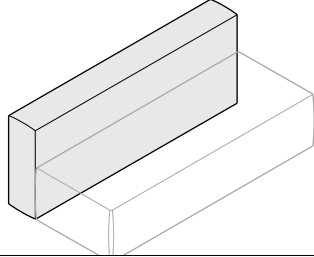
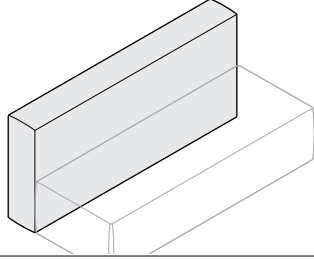
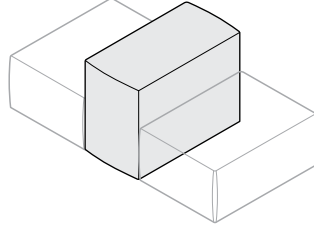
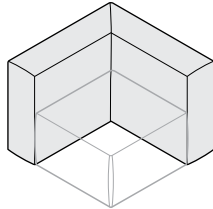
Series	Style	Type	Description	Ydg.	C.O.M.	A	B	C	D	E	F	G	H	I	J	K	L	M		
	YM	9	34	<b>Double Back</b> Boxed Front Depth 9" Height 26" Width 68"	4.4	53	1,259	1,520	1,662	1,800	1,942	2,084	2,239	2,395	2,578	2,816	3,101	3,384	3,663	3,947
	YM	9	35	<b>Double High Back</b> Boxed Front Depth 9" Height 30" Width 68"	4.8		1,431	1,712	1,863	2,012	2,165	2,317	2,485	2,651	2,848	3,105	3,410	3,715	4,016	4,321
	YM	9	36	<b>Back to Back</b> Boxed Front Depth 18" Height 26" Width 34"	3.3		916	1,112	1,218	1,321	1,428	1,534	1,650	1,768	1,905	2,084	2,296	2,509	2,719	2,932
	YM	9	37	<b>Corner Back</b> Boxed Front Depth 34" Height 26" Width 34"	3.5		1,030	1,239	1,354	1,463	1,576	1,690	1,815	1,940	2,086	2,276	2,503	2,731	2,953	3,180

To Order follow steps 1-5

### 1 Series/Style      2 Type      3 Seam Option      4 Decorative Stitch Colors      5 Fabrics

YM9

YM9 Yoom Boxed Front

34

34 Double Back

35

35 Double High Back

36

36 Back to Back

37

37 Corner Back

Seam Option

SS Single seam on all edges +00

SP Pinch seam on top edges  
Single seam on side edges +00

SW Standard welt cord on all edges +10% of COM List

Decorative Stitch on top edges (available on woven textiles only)

- SSD1 Basket stitch over single seam +10% of COM List
- SSD2 Zig Zag stitch over single seam +10% of COM List
- SSD3 Bowtie stitch over single seam +10% of COM List



Thread color must be specified.  
Reference Stylex/Stitching on Stylexseating.com for thread colors and stitch images.

Decorative Stitch Color

01 White

02 Natural

03 Lemon

04 Pebble Beige

05 Dk Mahogany

06 Orange

07 Red

08 Purple

09 Pro Blue

10 Navy

11 Olive

12 Dark Green

13 Nickel

14 Dark Gray

15 Black

Yoom Boxed is designed to have a casual look and feel. It is meant to show wrinkling with most fabrics.

Refer to Stylex swatch cards and separately published in-graded fabric program to determine grades.

See General Information section in the main price list for CAL 133 Information.

# Yoom Boxed - A La Carte

## Arm and Privacy Screens

Modular Lounge Systems

C.O.M.

C.O.M.  
Fabric Upholstery  
Grades

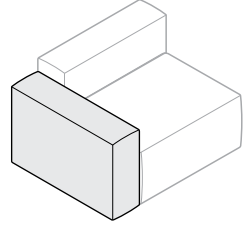
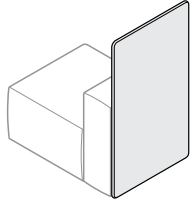
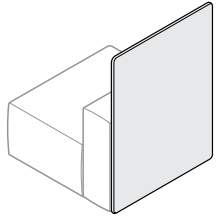
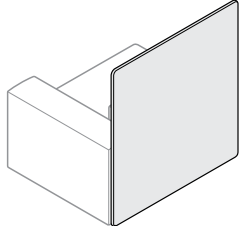
Series	Style	Type	Description	Ydg.	C.O.M.	A	B	C	D	E	F	G	H	I	J	K	L	M	
	YM	9	51	<b>Single Low Arm</b> Boxed Front Depth 9" Height 22" Width 34"	1.9	572	684	744	802	862	922	989	1,056	1,133	1,234	1,355	1,476	1,594	1,715
	YM	0	61	<b>25" Privacy Screen</b> Depth 1.5" Height 45" Width 25"	2.2	801	932	1,003	1,072	1,143	1,214	1,291	1,370	1,461	1,579	1,721	1,863	2,003	2,145
	YM	0	62	<b>34" Privacy Screen</b> Depth 1.5" Height 45" Width 34"	3.0	1,030	1,206	1,303	1,395	1,490	1,587	1,692	1,797	1,921	2,081	2,273	2,465	2,653	2,845
	YM	0	63	<b>43" Privacy Screen</b> Depth 1.5" Height 45" Width 43"	3.8	1,259	1,481	1,602	1,718	1,839	1,960	2,092	2,225	2,381	2,582	2,824	3,066	3,303	3,544

To Order follow steps 1-5

1 Series/Style	2 Type	3 Seam Option	4 Decorative Stitch Colors	5 Fabrics
----------------	--------	---------------	----------------------------	-----------

- YM Yoom Boxed Front

- 951 Single Low Arm
- 061 25" Privacy Screen
- 062 34" Privacy Screen
- 063 43" Privacy Screen

- Seam Option**
  - SS Single seam on all edges +00
  - SP Pinch seam on top edges\* +00
  - SW Standard welt cord on all edges\* +10% of COM List



- Decorative Stitch on all edges (available on woven textiles only)\***
  - SSD1 Basket stitch over single seam +10% of COM List
  - SSD2 Zig Zag stitch over single seam +10% of COM List
  - SSD3 Bowtie stitch over single seam +10% of COM List

Thread color must be specified.  
Reference Stylex/Stitching on Stylexseating.com for thread colors and stitch images.  
\*Not applicable w/privacy screens.

- Decorative Stitch Color**
  - 01 White
  - 02 Natural
  - 03 Lemon
  - 04 Pebble Beige
  - 05 Dk Mahogany
  - 06 Orange
  - 07 Red
  - 08 Purple
  - 09 Pro Blue
  - 10 Navy
  - 11 Olive
  - 12 Dark Green
  - 13 Nickel
  - 14 Dark Gray
  - 15 Black

Yoom Rolled fabrics must be cut up the roll.

**Yoom Boxed is designed to have a casual look and feel. It is meant to show wrinkling with most fabrics.**

Refer to Stylex swatch cards and separately published in-graded fabric program to determine grades .

See General Information section in the main price list for CAL 133 Information.

# Yoom Boxed

## Single Chairs

Modular Lounge Systems

C.O.M.

C.O.M.  
Fabric Upholstery  
Grades

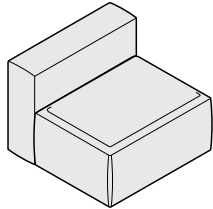
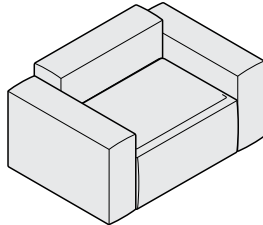
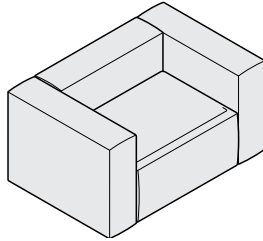
Series	Style	Type	Description	Ydg.	C.O.M.	A	B	C	D	E	F	G	H	I	J	K	L	M			
	YM	9	113100	<b>Single Chair Armless</b>																	
				Boxed Front	4.5	1,889	2,157	2,302	2,443	2,589	2,734	2,893	3,053	3,240	3,485	3,776	4,066	4,353	4,645		
				Depth	34"																
				Height	26"																
	YM	9	113151P	<b>Single Chair with Low Arms</b>																	
				Boxed Front	8.3	3,034	3,523	3,790	4,047	4,313	4,579	4,871	5,163	5,507	5,953	5,340	7,017	7,542	8,074		
				Depth	34"																
				Height	26"																
	YM	9	113131P	<b>Single Chair with High Arms</b>																	
				Boxed Front	8.8	3,263	3,784	4,068	4,344	4,627	4,911	5,223	5,534	5,900	6,377	6,944	7,512	8,071	8,639		
				Depth	34"																
				Height	26"																

To Order follow steps 1-7

1 Series/Style	2 Type	3 Seam Option	4 Decorative Stitch Colors	5 Glides/Casters/Legs	6 Options	7 Fabrics
<p>YM9 Yoom Boxed Front</p>	<p>113100 Single Chair Armless</p> <p>113151P Single Chair with Low Arms</p> <p>113131P Single Chair with High Arms</p>	<p><b>Seam Option</b></p> <p>SS Single seam on all edges +00</p> <p>SP Pinch seam on top edges Single seam on side edges +00</p> <p>SW Standard welt cord on all edges +10% of COM List</p> <p><b>Decorative Stitch on top edges (available on woven textiles only)</b></p> <p>SSD1 Basket stitch over single seam +10% of COM List</p> <p>SSD2 Zig Zag stitch over single seam +10% of COM List</p> <p>SSD3 Bowtie stitch over single seam +10% of COM List</p> <p>Thread color must be specified. Reference Stylex/Stitching on Stylexseating.com for thread colors and stitch images.</p>	<p><b>Decorative Stitch Color</b></p> <p>01 White</p> <p>02 Natural</p> <p>03 Lemon</p> <p>04 Pebble Beige</p> <p>05 Dk Mahogany</p> <p>06 Orange</p> <p>07 Red</p> <p>08 Purple</p> <p>09 Pro Blue</p> <p>10 Navy</p> <p>11 Olive</p> <p>12 Dark Green</p> <p>13 Nickel</p> <p>14 Dark Gray</p> <p>15 Black</p>	<p><b>Glide Options</b></p> <p>PG Plastic Glide +00 Recommended for easier movement on carpet.</p> <p>FG Felt Glide +00 Recommended for easier movement on hard floors.</p> <p>RG Rubber Glides +00 Recommended for static positioning.</p> <p><b>Caster Options</b></p> <p>CH Hard Wheel Caster +69 Recommended for full mobility in collaborative settings.</p> <p>CS Soft Wheel Caster +69 Recommended for full mobility in collaborative settings.</p> <p><b>L1 Round Legs</b> +119 Legs increase seating height by 2". All standard Stylex powder paints and Polished Aluminum are available leg finish choices.</p>	<p><b>G Ganging</b> +00</p> <p><b>C1X In-seat power port with 10' power cord</b> +357</p> <p><b>C2X In-seat power port with 20' power cord</b> +417</p> <p><b>W1X 12' BX whip (for hardwiring)</b> +714</p> <p><b>W2X 24' BX whip (for hardwiring)</b> +833</p> <p>See Page 6 for complete information on specifying power ports.</p>	<p><b>Yoom Boxed is designed to have a casual look and feel. It is meant to show wrinkling with most fabrics.</b></p> <p>Refer to Stylex swatch cards and separately published in-graded fabric program to determine grades .</p> <p>See General Information section in the main price list for CAL 133 Information.</p>

# Yoom Boxed

## Single Full Chairs

Modular Lounge Systems

C.O.M.

C.O.M.  
Fabric Upholstery  
Grades

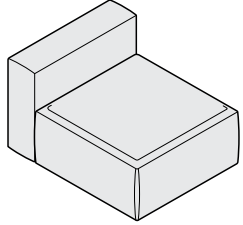
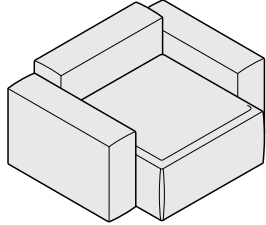
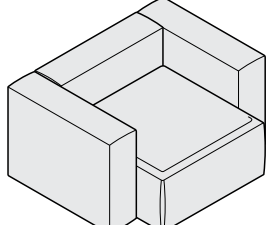
Series	Style	Type	Description	Ydg.	C.O.M.	A	B	C	D	E	F	G	H	I	J	K	L	M		
	YM	9	123100	<b>Single Full Chair Armless</b> Boxed Front Depth 43" Height 26" Seat Height 15" Width 34"	5.5	73	2,118	2,444	2,621	2,793	2,971	3,148	3,343	3,537	3,766	4,064	4,419	4,774	5,123	5,478
	YM	9	123151P	<b>Single Full Chair with Low Arms</b> Boxed Front Depth 43" Height 26" Seat Height 15" Arm Height 22" Width 52"	9.2		3,263	3,804	4,098	4,383	4,679	4,974	5,296	5,619	5,999	6,494	7,083	7,671	8,252	8,840
	YM	9	123131P	<b>Single Full Chair with High Arms</b> Boxed Front Depth 43" Height 26" Seat Height 15" Arm Height 26" Width 52"	9.7		3,492	4,066	4,378	4,680	4,993	5,305	5,648	5,990	6,393	6,917	7,542	8,166	8,781	9,405

To Order follow steps 1-7

1 Series/Style	2 Type	3 Seam Option	4 Decorative Stitch Colors	5 Glides/Casters/Legs	6 Options	7 Fabrics
<p><b>YM9</b> Yoom Boxed Front</p>	<p><b>123100</b> Single Full Chair Armless</p> <p><b>123151P</b> Single Full Chair with Low Arms</p> <p><b>123131P</b> Single Full Chair with High Arms</p>	<p><b>Seam Option</b></p> <p>SS Single seam on all edges +00</p> <p>SP Pinch seam on top edges Single seam on side edges +00</p> <p>SW Standard welt cord on all edges +10% of COM List</p> <p><b>Decorative Stitch on top edges</b> (available on woven textiles only)</p> <p>SSD1 Basket stitch over single seam +10% of COM List</p> <p>SSD2 Zig Zag stitch over single seam +10% of COM List</p> <p>SSD3 Bowtie stitch over single seam +10% of COM List</p> <p>Thread color must be specified. Reference Stylex/Stitching on Stylexseating.com for thread colors and stitch images.</p>	<p><b>Decorative Stitch Color</b></p> <p>01 White</p> <p>02 Natural</p> <p>03 Lemon</p> <p>04 Pebble Beige</p> <p>05 Dk Mahogany</p> <p>06 Orange</p> <p>07 Red</p> <p>08 Purple</p> <p>09 Pro Blue</p> <p>10 Navy</p> <p>11 Olive</p> <p>12 Dark Green</p> <p>13 Nickel</p> <p>14 Dark Gray</p> <p>15 Black</p>	<p><b>Glide Options</b></p> <p>PG Plastic Glide +00 Recommended for easier movement on carpet.</p> <p>FG Felt Glide +00 Recommended for easier movement on hard floors.</p> <p>RG Rubber Glides +00 Recommended for static positioning.</p> <p><b>Caster Options</b></p> <p>CH Hard Wheel Caster +69 Recommended for full mobility in collaborative settings.</p> <p>CS Soft Wheel Caster +69 Recommended for full mobility in collaborative settings.</p> <p><b>Round Legs</b> +119 Legs increase seating height by 2". All standard Stylex powder paints and Polished Aluminum are available leg finish choices.</p>	<p><b>G</b> Ganging +00</p> <p><b>C1X</b> In-seat power port with 10' power cord +357</p> <p><b>C2X</b> In-seat power port with 20' power cord +417</p> <p><b>W1X</b> 12' BX whip (for hardwiring) +714</p> <p><b>W2X</b> 24' BX whip (for hardwiring) +833</p> <p>See Page 6 for complete information on specifying power ports.</p>	<p><b>Yoom Boxed is designed to have a casual look and feel. It is meant to show wrinkling with most fabrics.</b></p> <p>Refer to Stylex swatch cards and separately published in-graded fabric program to determine grades.</p> <p>See General Information section in the main price list for CAL 133 Information.</p>

# Yoom Boxed

## Double Chairs

Modular Lounge Systems

C.O.M.

C.O.M.  
Fabric Upholstery  
Grades

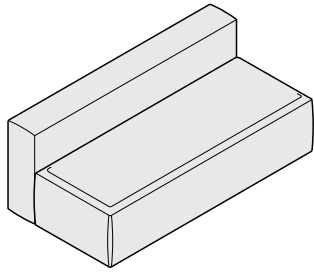
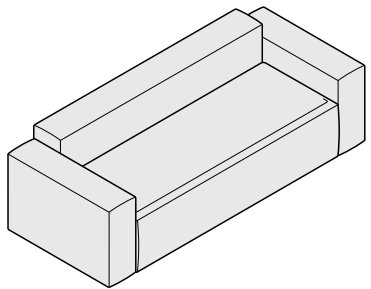
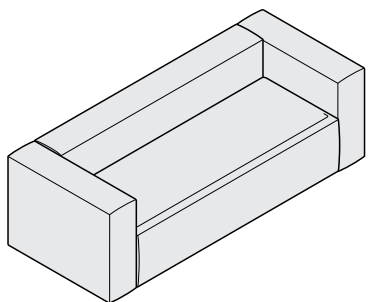
Series	Style	Type	Description	Ydg.	C.O.M.	A	B	C	D	E	F	G	H	I	J	K	L	M		
	YM	9	143400	<b>Double Chair Armless</b>	8.6	114	3,263	3,773	4,048	4,316	4,593	4,870	5,174	5,477	5,834	6,299	6,853	7,406	7,951	8,504
				Boxed Front																
				Depth 34"																
				Height 26"																
Seat Height 15"																				
Width 68"																				
	YM	9	143451P	<b>Double Chair with Low Arms</b>	12.2	4,407	5,133	5,526	5,907	6,301	6,695	7,126	7,559	8,068	8,728	9,516	10,303	11,079	11,867	
				Boxed Front																
				Depth 34"																
				Height 26"																
Seat Height 15"																				
Arm Height 22"																				
Width 86"																				
	YM	9	143431P	<b>Double Chair with High Arms</b>	12.8	4,636	5,393	5,806	6,204	6,614	7,027	7,478	7,930	8,461	9,152	9,975	10,798	11,608	12,432	
				Boxed Front																
				Depth 34"																
				Height 26"																
Seat Height 15"																				
Arm Height 26"																				
Width 86"																				

To Order follow steps 1-7

1 Series/Style	2 Type	3 Seam Option	4 Decorative Stitch Colors	5 Glides/Casters/Legs	6 Options	7 Fabrics
<p>YM9 Yoom Boxed Front</p>	<p>143400 Double Chair Armless</p> <p>143451P Double Chair with Low Arms</p> <p>143431P Double Chair with High Arms</p>	<p><b>Seam Option</b></p> <p>SS Single seam on all edges +00</p> <p>SP Pinch seam on top edges Single seam on side edges +00</p> <p>SW Standard welt cord on all edges +10% of COM List</p> <p><b>Decorative Stitch on top edges (available on woven textiles only)</b></p> <p>SSD1 Basket stitch over single seam +10% of COM List</p> <p>SSD2 Zig Zag stitch over single seam +10% of COM List</p> <p>SSD3 Bowtie stitch over single seam +10% of COM List</p> <p>Thread color must be specified. Reference Stylex/Stitching on Stylexseating.com for thread colors and stitch images.</p>	<p><b>Decorative Stitch Color</b></p> <p>01 White</p> <p>02 Natural</p> <p>03 Lemon</p> <p>04 Pebble Beige</p> <p>05 Dk Mahogany</p> <p>06 Orange</p> <p>07 Red</p> <p>08 Purple</p> <p>09 Pro Blue</p> <p>10 Navy</p> <p>11 Olive</p> <p>12 Dark Green</p> <p>13 Nickel</p> <p>14 Dark Gray</p> <p>15 Black</p>	<p><b>Glide Options</b></p> <p>PG Plastic Glide +00 Recommended for easier movement on carpet.</p> <p>FG Felt Glide +00 Recommended for easier movement on hard floors.</p> <p>RG Rubber Glides +00 Recommended for static positioning.</p> <p><b>L1 Round Legs</b> +119 Legs increase seating height by 2". All standard Stylex powder paints and Polished Aluminum are available leg finish choices.</p>	<p><b>G Ganging</b> +00</p> <p><b>C1X In-seat power port with 10' power cord</b> +357</p> <p><b>C2X In-seat power port with 20' power cord</b> +417</p> <p><b>W1X 12' BX whip (for hardwiring)</b> +714</p> <p><b>W2X 24' BX whip (for hardwiring)</b> +833</p> <p>See Page 6 for complete information on specifying power ports.</p>	<p><b>Yoom Boxed is designed to have a casual look and feel. It is meant to show wrinkling with most fabrics.</b></p> <p>Refer to Stylex swatch cards and separately published in-graded fabric program to determine grades .</p> <p>See General Information section in the main price list for CAL 133 Information.</p>





# Yoom Boxed

## Double Full Chairs

Modular Lounge Systems

C.O.M.

C.O.M.  
Fabric Upholstery  
Grades

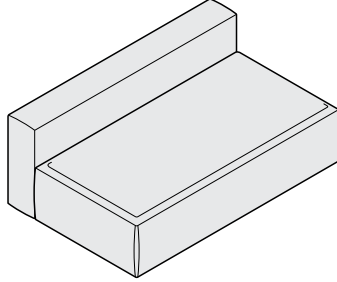
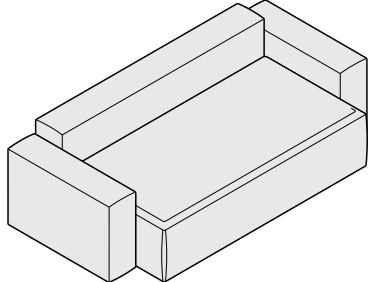
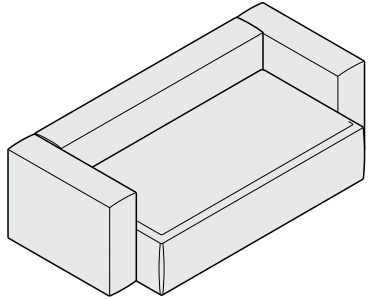
Series	Style	Type	Description	Ydg.	C.O.M.	A	B	C	D	E	F	G	H	I	J	K	L	M	
	YM	9	153400	<b>Double Full Chair Armless</b> Boxed Front Depth 43" Height 26" Seat Height 15" Width 68"	8.6 125	3,721	4,295	4,607	4,909	5,222	5,534	5,877	6,219	6,622	7,145	7,771	8,395	9,010	9,634
	YM	9	153451P	<b>Double Full Chair with Low Arms</b> Boxed Front Depth 43" Height 26" Seat Height 15" Arm Height 22" Width 86"	12.4	4,865	5,655	6,084	6,500	6,929	7,359	7,829	8,301	8,855	9,575	10,434	11,292	12,138	12,997
	YM	9	153431P	<b>Double Full Chair with High Arms</b> Boxed Front Depth 43" Height 26" Seat Height 15" Arm Height 26" Width 86"	12.9	5,094	5,916	6,364	6,797	7,243	7,690	8,181	8,672	9,249	9,999	10,893	11,787	12,667	13,562

To Order follow steps 1-7

**1 Series/Style    2 Type    3 Seam Option    4 Decorative Stitch Colors    5 Glides/Casters/Legs    6 Options    7 Fabrics**

<p><b>1 Series/Style</b></p> <p>YM9 Yoom Boxed Front</p>	<p><b>2 Type</b></p> <p>153400 Double Full Chair Armless</p> <p>153451P Double Full Chair with Low Arms</p> <p>153431P Double Full Chair with High Arms</p>	<p><b>3 Seam Option</b></p> <p>SS Single seam on all edges +00</p> <p>SP Pinch seam on top edges Single seam on side edges +00</p> <p>SW Standard welt cord on all edges +10% of COM List</p> <p><b>Decorative Stitch on top edges (available on woven textiles only)</b></p> <p>SSD1 Basket stitch over single seam +10% of COM List</p> <p>SSD2 Zig Zag stitch over single seam +10% of COM List</p> <p>SSD3 Bowtie stitch over single seam +10% of COM List</p> <p>Thread color must be specified. Reference Stylex/Stitching on <a href="http://Stylexseating.com">Stylexseating.com</a> for thread colors and stitch images.</p>	<p><b>4 Decorative Stitch Color</b></p> <p>01 White</p> <p>02 Natural</p> <p>03 Lemon</p> <p>04 Pebble Beige</p> <p>05 Dk Mahogany</p> <p>06 Orange</p> <p>07 Red</p> <p>08 Purple</p> <p>09 Pro Blue</p> <p>10 Navy</p> <p>11 Olive</p> <p>12 Dark Green</p> <p>13 Nickel</p> <p>14 Dark Gray</p> <p>15 Black</p>	<p><b>5 Glides/Casters/Legs</b></p> <p>PG Plastic Glide Recommended for easier movement on carpet. +00</p> <p>FG Felt Glide Recommended for easier movement on hard floors. +00</p> <p>RG Rubber Glides Recommended for static positioning. +00</p> <p><b>L1 Round Legs</b> Legs increase seating height by 2". All standard Stylex powder paints and Polished Aluminum are available leg finish choices. +119</p>	<p><b>6 Options</b></p> <p>G Ganging +00</p> <p>C1X In-seat power port with 10' power cord +357</p> <p>C2X In-seat power port with 20' power cord +417</p> <p>W1X 12' BX whip (for hardwiring) +714</p> <p>W2X 24' BX whip (for hardwiring) +833</p> <p>See Page 6 for complete information on specifying power ports.</p>	<p><b>7 Fabrics</b></p> <p>Yoom Boxed is designed to have a casual look and feel. It is meant to show wrinkling with most fabrics.</p> <p>Refer to Stylex swatch cards and separately published in-graded fabric program to determine grades.</p> <p>See General Information section in the main price list for CAL 133 Information.</p>
--	---	---	--	--	--	--

# Yoom Boxed

## Chaise Right and Left

Modular Lounge Systems

C.O.M.

C.O.M.  
Fabric Upholstery  
Grades

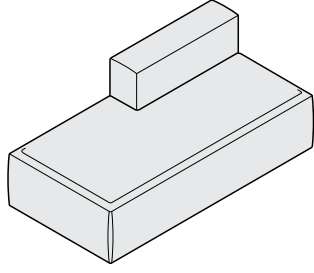
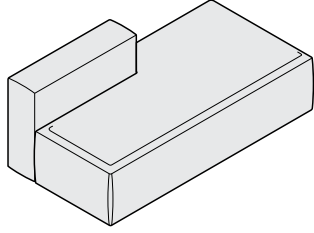
Series	Style	Type	Description	Ydg.	C.O.M.	A	B	C	D	E	F	G	H	I	J	K	L	M		
	YM	9	1631	<b>Chaise Right</b> Boxed Front Depth 34" Height 26" Seat Height 15" Width 68"	7.4	94	3,148	3,586	3,823	4,053	4,291	4,528	4,790	5,051	5,357	5,756	6,231	6,708	7,175	7,651
	YM	9	1731	<b>Chaise Left</b> Boxed Front Depth 34" Height 26" Seat Height 15" Width 68"	7.4		3,148	3,586	3,823	4,053	4,291	4,528	4,790	5,051	5,357	5,756	6,231	6,708	7,175	7,651

To Order follow steps 1-7

1 Series/Style	2 Type	3 Seam Option	4 Decorative Stitch Colors	5 Glides/Casters/Legs	6 Options	7 Fabrics
<p>YM9 Yoom Boxed Front</p>	<p>1631 Chaise Right</p> <p>1731 Chaise Left</p>	<p><b>Seam Option</b></p> <p>SS Single seam on all edges +00</p> <p>SP Pinch seam on top edges Single seam on side edges +00</p> <p>SW Standard welt cord on all edges +10% of COM List</p> <p><b>Decorative Stitch on top edges</b> (available on woven textiles only)</p> <p>SSD1 Basket stitch over single seam +10% of COM List</p> <p>SSD2 Zig Zag stitch over single seam +10% of COM List</p> <p>SSD3 Bowtie stitch over single seam +10% of COM List</p> <p>Thread color must be specified. Reference Stylex/Stitching on Stylexseating.com for thread colors and stitch images.</p>	<p><b>Decorative Stitch Color</b></p> <p>01 White</p> <p>02 Natural</p> <p>03 Lemon</p> <p>04 Pebble Beige</p> <p>05 Dk Mahogany</p> <p>06 Orange</p> <p>07 Red</p> <p>08 Purple</p> <p>09 Pro Blue</p> <p>10 Navy</p> <p>11 Olive</p> <p>12 Dark Green</p> <p>13 Nickel</p> <p>14 Dark Gray</p> <p>15 Black</p>	<p><b>Glide Options</b></p> <p>PG Plastic Glide +00 Recommended for easier movement on carpet.</p> <p>FG Felt Glide +00 Recommended for easier movement on hard floors.</p> <p>RG Rubber Glides +00 Recommended for static positioning.</p> <p>L1 <b>Round Legs</b> +119 Legs increase seating height by 2". All standard Stylex powder paints and Polished Aluminum are available leg finish choices.</p>	<p>G Ganging +00</p> <p>C1X In-seat power port with 10' power cord +357</p> <p>C2X In-seat power port with 20' power cord +417</p> <p>W1X 12' BX whip (for hardwiring) +714</p> <p>W2X 24' BX whip (for hardwiring) +833</p> <p>See Page 6 for complete information on specifying power ports.</p>	<p>Yoom Boxed is designed to have a casual look and feel. It is meant to show wrinkling with most fabrics.</p> <p>Refer to Stylex swatch cards and separately published in-graded fabric program to determine grades.</p> <p>See General Information section in the main price list for CAL 133 Information.</p>

# Yoom Boxed

## Corner and Narrow Chair



Modular Lounge Systems

C.O.M.

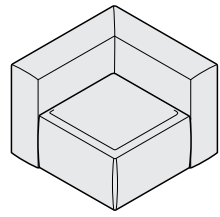
C.O.M.  
Fabric Upholstery  
Grades

Series	Style	Type	Description	Ydg.	C.O.M.	A	B	C	D	E	F	G	H	I	J	K	L	M	
	YM	9	1337	<b>Corner Chair</b> Boxed Front Depth 34" Height 26" Seat Height 15" Width 34"	5.0	2,003	2,303	2,467	2,625	2,788	2,951	3,164	3,309	3,520	3,794	4,120	4,447	4,768	5,094
	YM	9	1333	<b>Narrow Chair</b> Boxed Front Depth 34" Height 26" Seat Height 15" Width 25"	3.3	1,603	1,799	1,905	2,008	2,115	2,221	2,337	2,455	2,592	2,771	2,983	3,196	3,406	3,619

To Order follow steps 1-7

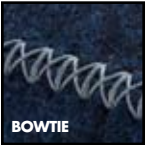
1 Series/Style	2 Type	3 Seam Option	4 Decorative Stitch Colors	5 Glides/Casters/Legs	6 Options	7 Fabrics
<p>YM9 Yoom Boxed Front</p>	<p>1337 Corner Chair</p> <p>1333 Narrow Chair</p>	<p><b>Seam Option</b></p> <p>SS Single seam on all edges +00</p> <p>SP Pinch seam on top edges Single seam on side edges +00</p> <p>SW Standard welt cord on all edges +10% of COM List</p> <p><b>Decorative Stitch on top edges</b> (available on woven textiles only)</p> <p>SSD1 Basket stitch over single seam +10% of COM List</p> <p>SSD2 Zig Zag stitch over single seam +10% of COM List</p> <p>SSD3 Bowtie stitch over single seam +10% of COM List</p> <p>Thread color must be specified. Reference Stylex/Stitching on <a href="http://Stylexseating.com">Stylexseating.com</a> for thread colors and stitch images.</p>   	<p><b>Decorative Stitch Color</b></p> <p>01 White</p> <p>02 Natural</p> <p>03 Lemon</p> <p>04 Pebble Beige</p> <p>05 Dk Mahogany</p> <p>06 Orange</p> <p>07 Red</p> <p>08 Purple</p> <p>09 Pro Blue</p> <p>10 Navy</p> <p>11 Olive</p> <p>12 Dark Green</p> <p>13 Nickel</p> <p>14 Dark Gray</p> <p>15 Black</p>	<p><b>Glide Options</b></p> <p>PG Plastic Glide +00 Recommended for easier movement on carpet.</p> <p>FG Felt Glide +00 Recommended for easier movement on hard floors.</p> <p>RG Rubber Glides +00 Recommended for static positioning.</p> <p><b>Caster Options</b></p> <p>CH Hard Wheel Caster +69 Recommended for full mobility in collaborative settings.</p> <p>CS Soft Wheel Caster +69 Recommended for full mobility in collaborative settings.</p> <p><b>Round Legs</b> +119 Legs increase seating height by 2". All standard Stylex powder paints and Polished Aluminum are available leg finish choices.</p>	<p><b>Ganging</b> +00</p> <p>C1X In-seat power port with 10' power cord +357</p> <p>C2X In-seat power port with 20' power cord +417</p> <p>W1X 12' BX whip (for hardwiring) +714</p> <p>W2X 24' BX whip (for hardwiring) +833</p> <p>See Page 6 for complete information on specifying power ports.</p>	<p>Yoom Boxed is designed to have a casual look and feel. It is meant to show wrinkling with most fabrics.</p> <p>Refer to Stylex swatch cards and separately published in-graded fabric program to determine grades.</p> <p>See General Information section in the main price list for CAL 133 Information.</p>

# Yoom Boxed

## Single Chair with Right or Left Arm

Modular Lounge Systems

C.O.M.

C.O.M.  
Fabric Upholstery  
Grades

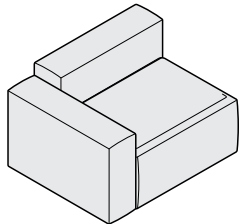
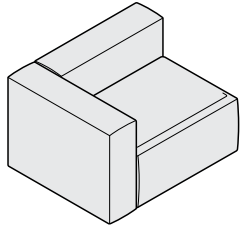
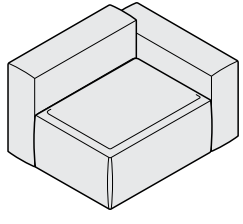
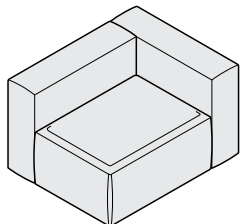
Series	Style	Type	Description	Ydg.	C.O.M.	A	B	C	D	E	F	G	H	I	J	K	L	M	
	YM	9	113151R	<b>Single Chair with Right Low Arm</b>	6.4 95	2,461	2,840	3,045	3,245	3,450	3,657	3,882	4,108	4,374	4,719	5,131	5,542	5,948	6,359
				Boxed Front															
				Depth 34"															
				Height 26"															
				Seat Height 15"															
Arm Height 22"																			
Width 43"																			
	YM	9	113131R	<b>Single Chair with Right High Arm</b>	6.8	2,576	2,974	3,191	3,400	3,617	3,833	4,069	4,308	4,588	4,950	5,383	5,815	6,242	6,675
				Boxed Front															
				Depth 34"															
				Height 26"															
				Seat Height 15"															
Arm Height 26"																			
Width 43"																			
	YM	9	113151L	<b>Single Chair with Left Low Arm</b>	6.4 95	2,461	2,840	3,045	3,245	3,450	3,657	3,882	4,108	4,374	4,719	5,131	5,542	5,948	6,359
				Boxed Front															
				Depth 34"															
				Height 26"															
				Seat Height 15"															
Arm Height 22"																			
Width 43"																			
	YM	9	113131L	<b>Single Chair with Left High Arm</b>	6.8	2,576	2,974	3,191	3,400	3,617	3,833	4,069	4,308	4,588	4,950	5,383	5,815	6,242	6,675
				Boxed Front															
				Depth 34"															
				Height 26"															
				Seat Height 15"															
Arm Height 26"																			
Width 43"																			

To Order follow steps 1-7

**1 Series/Style    2 Type    3 Seam Option    4 Decorative Stitch Colors    5 Glides/Casters/Legs    6 Options    7 Fabrics**

**YM9** Yoom Boxed Front

**113151R** Single Chair with Right Low Arm

**113131R** Single Chair with Right High Arm

**113151L** Single Chair with Left Low Arm

**113131L** Single Chair with Left High Arm

**Seam Option**

SS Single seam on all edges +00

SP Pinch seam on top edges  
Single seam on side edges +00

SW Standard welt cord on all edges +10% of COM List

**Decorative Stitch on top edges (available on woven textiles only)**

SSD1 Basket stitch over single seam +10% of COM List

SSD2 Zig Zag stitch over single seam +10% of COM List

SSD3 Bowtie stitch over single seam +10% of COM List

Thread color must be specified.  
Reference Stylex/Stitching on [Stylexseating.com](http://Stylexseating.com) for thread colors and stitch images.

**Decorative Stitch Color**

01 White

02 Natural

03 Lemon

04 Pebble Beige

05 Dk Mahogany

06 Orange

07 Red

08 Purple

09 Pro Blue

10 Navy

11 Olive

12 Dark Green

13 Nickel

14 Dark Gray

15 Black

**Glide Options**

PG Plastic Glide +00  
Recommended for easier movement on carpet.

FG Felt Glide +00  
Recommended for easier movement on hard floors.

RG Rubber Glides +00  
Recommended for static positioning.

**Caster Options**

CH Hard Wheel Caster +69  
Recommended for full mobility in collaborative settings.

CS Soft Wheel Caster +69  
Recommended for full mobility in collaborative settings.

**L1 Round Legs** +119  
Legs increase seating height by 2".  
All standard Stylex powder paints and Polished Aluminum are available leg finish choices.

**G Ganging** +00

**C1X** In-seat power port with 10' power cord +357

**C2X** In-seat power port with 20' power cord +417

**W1X** 12' BX whip (for hardwiring) +714

**W2X** 24' BX whip (for hardwiring) +833

See Page 6 for complete information on specifying power ports.

**Yoom Boxed is designed to have a casual look and feel. It is meant to show wrinkling with most fabrics.**

Refer to Stylex swatch cards and separately published in-graded fabric program to determine grades .

See General Information section in the main price list for CAL 133 Information.



# Yoom Boxed

## Single Full Chair with Right or Left Arm

Modular Lounge Systems

C.O.M.

C.O.M.  
Fabric Upholstery  
Grades

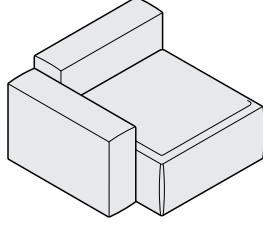
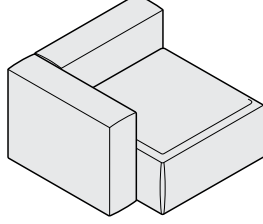
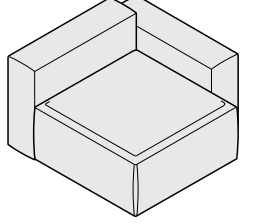
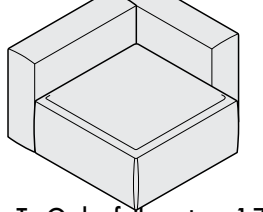
Series	Style	Type	Description	Ydg.	C.O.M.	A	B	C	D	E	F	G	H	I	J	K	L	M	
	YM	9	123151R	<b>Single Full Chair with Right Low Arm</b>	7.3	2,690	3,121	3,355	3,582	3,816	4,050	4,307	4,564	4,866	5,260	5,727	6,196	6,657	7,125
				Boxed Front															
				Depth 43"															
				Height 26"															
				Seat Height 15"															
Arm Height 22"																			
Width 43"																			
	YM	9	123131R	<b>Single Full Chair with Right High Arm</b>	7.6	2,805	3,254	3,500	3,737	3,981	4,226	4,495	4,764	5,080	5,491	5,981	6,470	6,953	7,441
				Boxed Front															
				Depth 43"															
				Height 26"															
				Seat Height 15"															
Arm Height 26"																			
Width 43"																			
	YM	9	123151L	<b>Single Full Chair with Left Low Arm</b>	7.3	2,690	3,121	3,355	3,582	3,816	4,050	4,307	4,564	4,866	5,260	5,727	6,196	6,657	7,125
				Boxed Front															
				Depth 43"															
				Height 26"															
				Seat Height 15"															
Arm Height 22"																			
Width 43"																			
	YM	9	123131L	<b>Single Full Chair with Left High Arm</b>	7.6	2,805	3,254	3,500	3,737	3,981	4,226	4,495	4,764	5,080	5,491	5,981	6,470	6,953	7,441
				Boxed Front															
				Depth 43"															
				Height 26"															
				Seat Height 15"															
Arm Height 26"																			
Width 43"																			

To Order follow steps 1-7

**1 Series/Style    2 Type    3 Seam Option    4 Decorative Stitch Colors    5 Glides/Casters/Legs    6 Options    7 Fabrics**

**1 Series/Style**

YM9 Yoom Boxed Front

**2 Type**

- 123151R Single Full Chair with Right Low Arm
- 123131R Single Full Chair with Right High Arm
- 123151L Single Full Chair with Left Low Arm
- 123131L Single Full Chair with Left High Arm

**3 Seam Option**

- SS Single seam on all edges +00
- SP Pinch seam on top edges  
Single seam on side edges +00
- SW Standard welt cord on all edges +10% of COM List

**Decorative Stitch on top edges** (available on woven textiles only)

- SSD1 Basket stitch over single seam +10% of COM List
- SSD2 Zig Zag stitch over single seam +10% of COM List
- SSD3 Bowtie stitch over single seam +10% of COM List

Thread color must be specified.  
Reference Stylex/Stitching on [Stylexseating.com](http://Stylexseating.com) for thread colors and stitch images.

**4 Decorative Stitch Colors**

- 01 White
- 02 Natural
- 03 Lemon
- 04 Pebble Beige
- 05 Dk Mahogany
- 06 Orange
- 07 Red
- 08 Purple
- 09 Pro Blue
- 10 Navy
- 11 Olive
- 12 Dark Green
- 13 Nickel
- 14 Dark Gray
- 15 Black

**5 Glides/Casters/Legs**

**Glide Options**

- PG Plastic Glide +00  
Recommended for easier movement on carpet.
- FG Felt Glide +00  
Recommended for easier movement on hard floors.
- RG Rubber Glides +00  
Recommended for static positioning.

**Caster Options**

- CH Hard Wheel Caster +69  
Recommended for full mobility in collaborative settings.
- CS Soft Wheel Caster +69  
Recommended for full mobility in collaborative settings.

**L1 Round Legs** +119  
Legs increase seating height by 2".  
All standard Stylex powder paints and Polished Aluminum are available leg finish choices.

**6 Options**

- G Ganging +00
- C1X In-seat power port with 10' power cord +357
- C2X In-seat power port with 20' power cord +417
- W1X 12' BX whip (for hardwiring) +714
- W2X 24' BX whip (for hardwiring) +833

See Page 6 for complete information on specifying power ports.

**7 Fabrics**

Yoom Boxed is designed to have a casual look and feel. It is meant to show wrinkling with most fabrics.

Refer to Stylex swatch cards and separately published in-graded fabric program to determine grades.

See General Information section in the main price list for CAL 133 Information.