

Prices Effective
July 1, 2018

STREETX

Yoom Rolled

Price List

Yoom Rolled - A La Carte

Product Information Applications:

Modular Lounge Systems

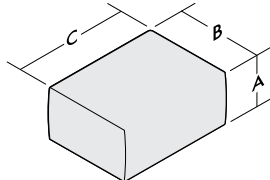
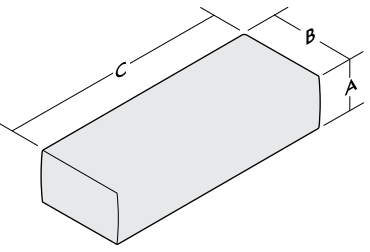
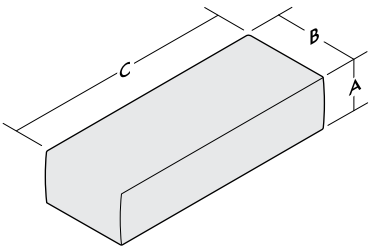
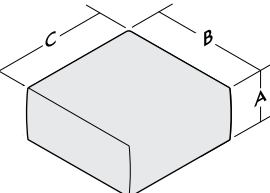
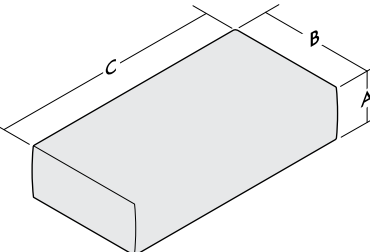
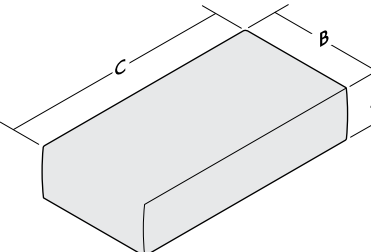
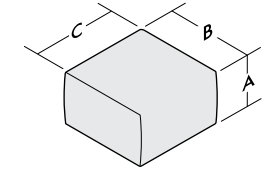
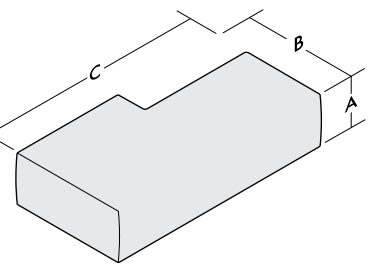
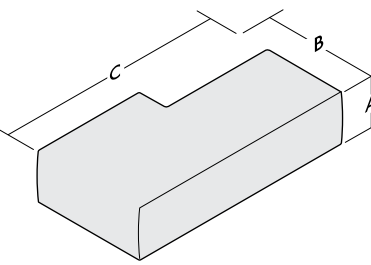
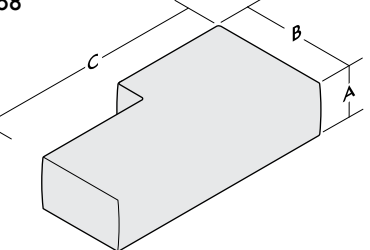
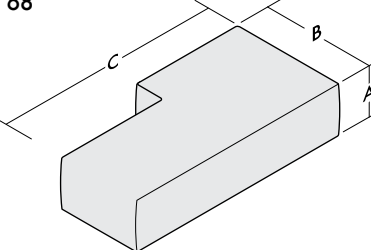
Dimensions / Overview	Single Seat	Double Seat/Chaise Seat	Double Seat/Chaise Seat	General Information
General Dimensions A. Height B. Depth C. Width	Single Seat A. 15" B. 25" C. 34" 	Double Seat A. 15" B. 25" C. 68" 	Double Seat A. 15" B. 25" C. 68" 	Design Stylex/Anthony Land Construction Internal frames are built from 5/8" PS 1-09 certified plywood. All surfaces are covered with foam of varying thicknesses and densities, depending on the particular unit. Chairs incorporate Dymetrol webbing in the seat for added comfort. Ganging All individual units may be connected to one another with the use of a forked latch system. Glides Yoom Rolled is available with 3 glide options: plastic, rubber, and felt. Casters Yoom Rolled is available with 2 caster options: hard and soft. Power Optional power receptacle offers three exposed power ports: 2 USB 2.1A ports and a standard, grounded 3-prong electrical outlet. Testing Manufactured to comply with ANSI/BIFMA X5.4 Lounge Seating Tests. Environment Greenguard Certified.
	Single Full Seat A. 15" B. 34" C. 34" 	Double Full Seat A. 15" B. 34" C. 68" 	Double Full Seat A. 15" B. 34" C. 68" 	
	Single Narrow Seat A. 15" B. 25" C. 25" 	Chaise Right A. 15" B. 34" C. 68" 	Chaise Right A. 15" B. 34" C. 68" 	
		Chaise Left A. 15" B. 34" C. 68" 	Chaise Left A. 15" B. 34" C. 68" 	

Please note that there is 1" of clearance between the floor and all Yoom components.

Yoom Rolled - A La Carte

Product Information Applications:

Modular Lounge Systems

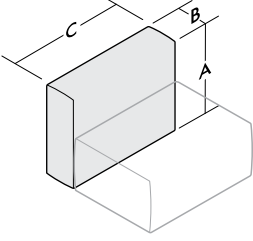
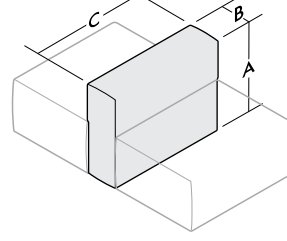
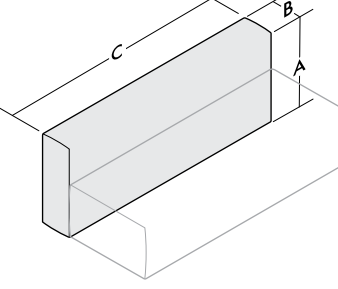
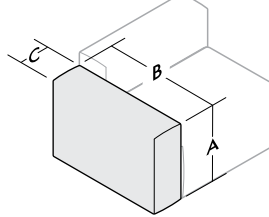
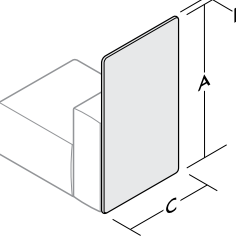
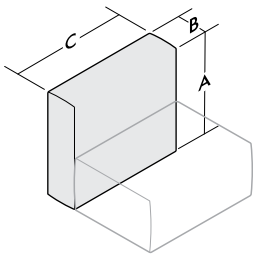
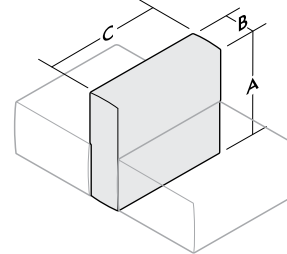
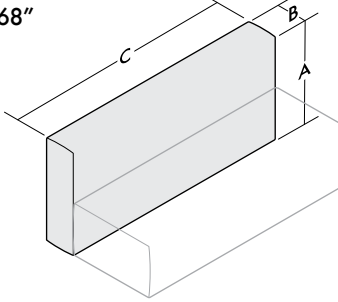
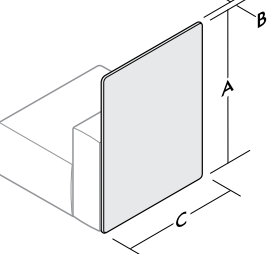
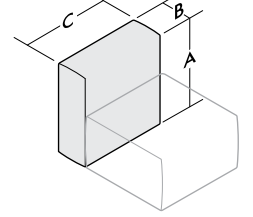
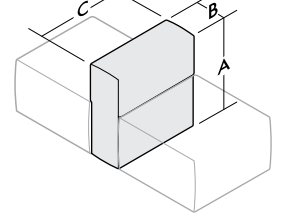
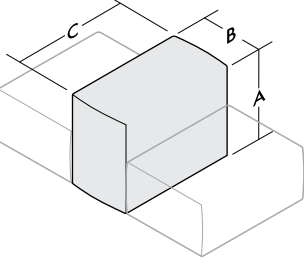
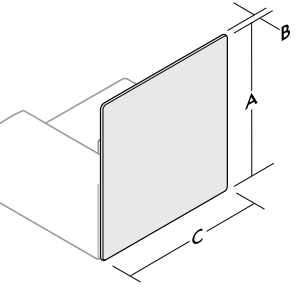
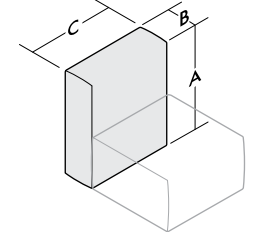
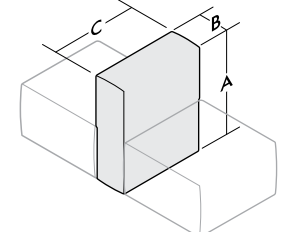
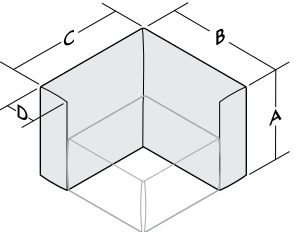
Dimensions / Overview	Single Back	Single Thin Back to Back	Double Back	Arm	Screens	General Information
General Dimensions A. Height B. Depth C. Width	Single Back A. 26" B. 9" C. 34" 	Single Thin Back to Back A. 26" B. 9" C. 34" 	Double Back A. 26" B. 9" C. 68" 	Single Low Arm A. 22" B. 34" C. 9" 	25" Privacy Screen A. 45" B. 1.5" C. 25" 	Design Stylex/Anthony Land Construction Internal frames are built from 5/8" PS 1-09 certified plywood. All surfaces are covered with foam of varying thicknesses and densities, depending on the particular unit. Chairs incorporate Dymetrol webbing in the seat for added comfort. Ganging All individual units may be connected to one another with the use of a forked latch system. Glides Yoom Rolled is available with 3 glide options: plastic, rubber, and felt. Casters Yoom Rolled is available with 2 caster options: hard and soft. Power Optional power receptacle offers three exposed power ports: 2 USB 2.1A ports and a standard, grounded 3-prong electrical outlet. Testing Manufactured to comply with ANSI/BIFMA X5.4 Lounge Seating Tests. Environment Greenguard Certified.
	Single High Back A. 30" B. 9" C. 34" 	Single High Thin Back to Back A. 30" B. 9" C. 34" 	Double High Back A. 30" B. 9" C. 68" 		34" Privacy Screen A. 45" B. 1.5" C. 34" 	
	Single Narrow Back A. 26" B. 9" C. 25" 	Single Narrow Thin Back to Back A. 26" B. 9" C. 25" 	Back to Back A. 26" B. 18" C. 34" 		43" Privacy Screen A. 45" B. 1.5" C. 43" 	
	Single Narrow High Back A. 30" B. 9" C. 25" 	Single Narrow High Thin Back to Back A. 30" B. 9" C. 25" 	Corner Back A. 26" B. 34" C. 34" D. 9" 			

Please note that there is 1" of clearance between the floor and all Yoom components.

Yoom Rolled

Product Information Applications - Chairs

Modular Lounge Systems

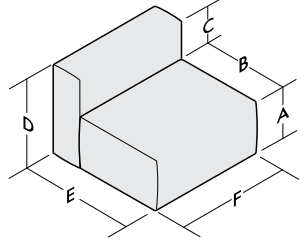
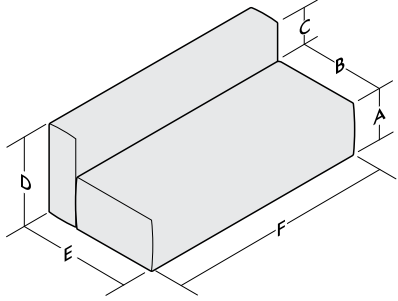
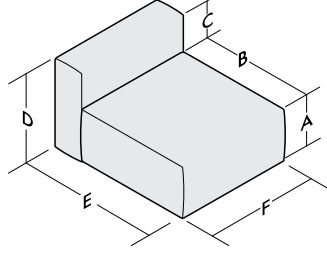
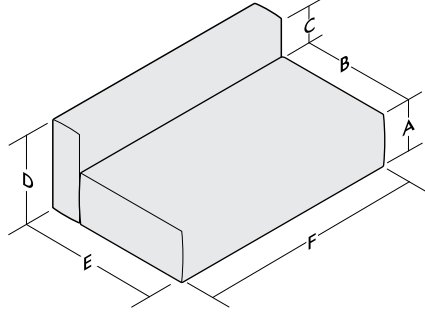
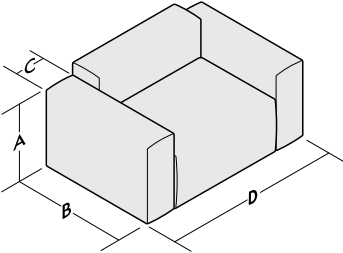
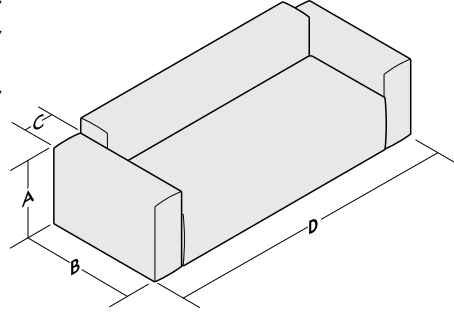
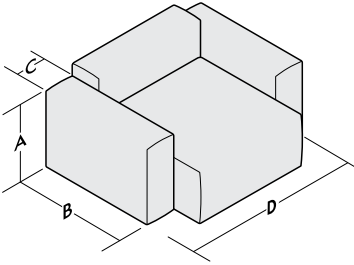
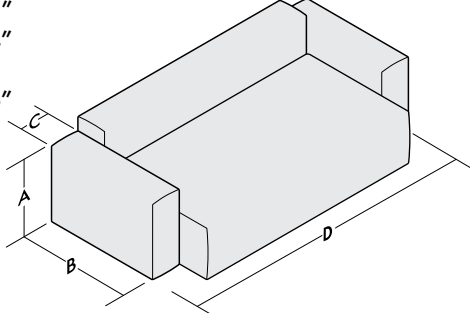
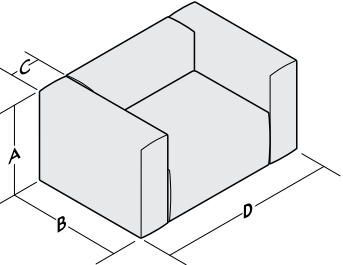
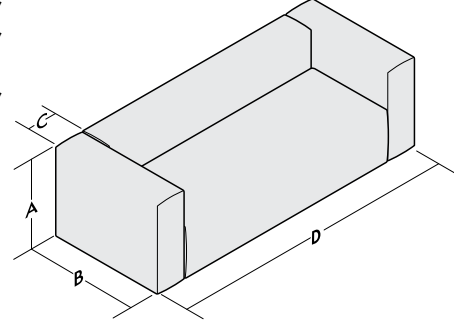
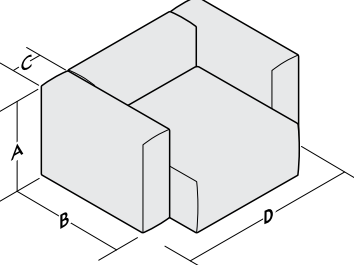
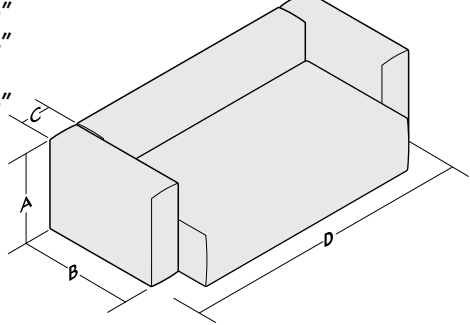
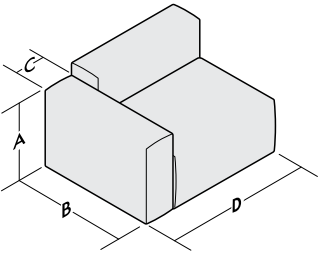
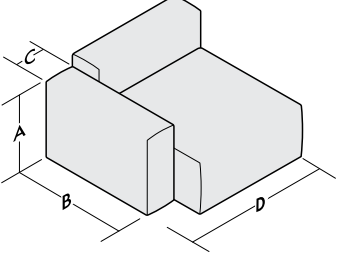
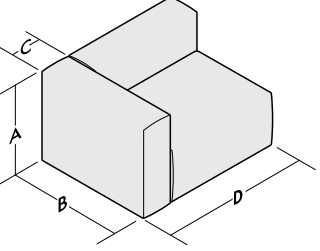
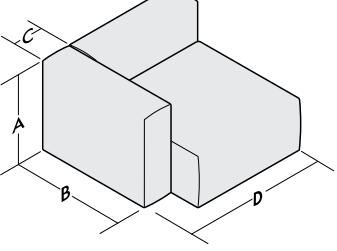
Dimensions / Overview	Single Chair	Double Chair	Single Full Chair	Double Full Chair	General Information
General Dimensions A. Seat Height B. Seat Depth C. Back Height D. Overall Height E. Overall Depth F. Overall Width	Single Chair Armless A. 15" B. 25" C. 11" D. 26" E. 34" F. 34" 	Double Chair Armless A. 15" B. 25" C. 11" D. 26" E. 34" F. 68" 	Single Full Chair Armless A. 15" B. 34" C. 11" D. 26" E. 43" F. 34" 	Double Full Chair Armless A. 15" B. 34" C. 11" D. 26" E. 43" F. 68" 	Design Stylex/Anthony Land Construction Internal frames are built from 5/8" PS 1-09 certified plywood. All surfaces are covered with foam of varying thicknesses and densities, depending on the particular unit. Chairs incorporate Dymetrol webbing in the seat for added comfort. Ganging All individual units may be connected to one another with the use of a forked latch system. Glides Yoom Rolled is available with 3 glide options: plastic, rubber, and felt. Casters Yoom Rolled is available with 2 caster options: hard and soft. Power Optional power receptacle offers three exposed power ports: 2 USB 2.1A ports and a standard, grounded 3-prong electrical outlet. Testing Manufactured to comply with ANSI/BIF-MA X5.4 Lounge Seating Tests. Environment Greenguard Certified.
Arms Low A. Height B. Depth C. Width D. Overall Width Arms	Single Chair Low Arms A. 22" B. 34" C. 9" D. 52" 	Double Chair Low Arms A. 22" B. 34" C. 9" D. 86" 	Single Full Chair Low Arms A. 22" B. 34" C. 9" D. 52" 	Double Full Chair Low Arms A. 22" B. 34" C. 9" D. 86" 	
Arms High A. Height B. Depth C. Width D. Overall Width Arms	Single Chair High Arms A. 26" B. 34" C. 9" D. 52" 	Double Chair High Arms A. 26" B. 34" C. 9" D. 86" 	Single Full Chair High Arms A. 26" B. 34" C. 9" D. 52" 	Double Full Chair High Arms A. 26" B. 34" C. 9" D. 86" 	
Arm Low Right or Left A. Height B. Depth C. Width D. Overall Width with Arm	Single Chair with Right Low Arm A. 22" B. 34" C. 9" D. 43" 		Single Full Chair with Right Low Arm A. 22" B. 34" C. 9" D. 43" 		
Arm High Right or Left A. Height B. Depth C. Width D. Overall Width with Arm	Single Chair with Right High Arm A. 26" B. 34" C. 9" D. 43" 		Single Full Chair with Right High Arm A. 26" B. 34" C. 9" D. 43" 		

Yoom Rolled

Product Information Applications - Chairs



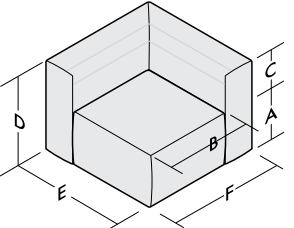
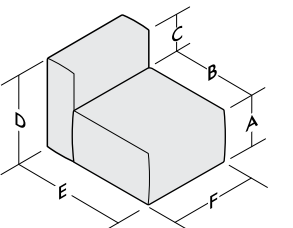
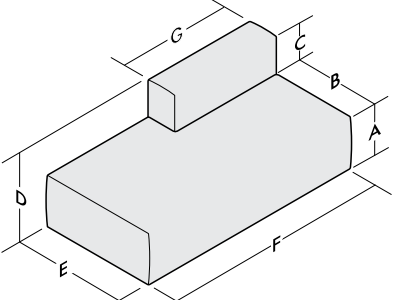
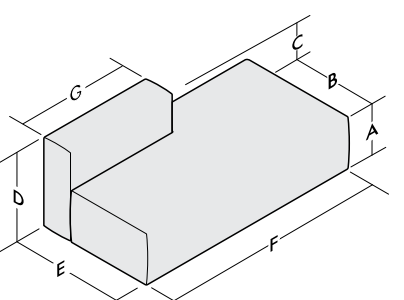





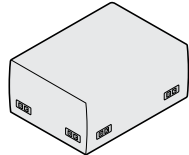

Modular Lounge Systems

Dimensions / Overview	Corner Chair	Single Narrow Chair	Chaise Right	Chaise Left	
<p>General Dimensions</p> <ul style="list-style-type: none"> A. Seat Height B. Seat Depth C. Back Height D. Overall Height E. Overall Depth F. Overall Width G. Back Width 	<p>Corner Chair</p> <ul style="list-style-type: none"> A. 15" B. 25" C. 11" D. 26" E. 34" F. 34" G. 34" 	<p>Single Narrow Chair</p> <ul style="list-style-type: none"> A. 15" B. 25" C. 11" D. 26" E. 34" F. 25" G. 34" 	<p>Chaise Right</p> <p>Rolled Front Shown</p> <ul style="list-style-type: none"> A. 15" B. 25" C. 11" D. 26" E. 34" F. 68" G. 34" 	<p>Chaise Left</p> <p>Rolled Front Shown</p> <ul style="list-style-type: none"> A. 15" B. 25" C. 11" D. 26" E. 34" F. 68" G. 34" 	<p>Design Stylex/Anthony Land</p> <p>Construction Internal frames are built from 5/8" PS 1-09 certified plywood. All surfaces are covered with foam of varying thicknesses and densities, depending on the particular unit. Chairs incorporate Dymetrol webbing in the seat for added comfort.</p> <p>Ganging All individual units may be connected to one another with the use of a forked latch system.</p> <p>Glides Yoom Rolled is available with 3 glide options: plastic, rubber, and felt.</p> <p>Casters Yoom Rolled is available with 2 caster options: hard and soft.</p> <p>Power Optional power receptacle offers three exposed power ports: 2 USB 2.1A ports and a standard, grounded 3-prong electrical outlet.</p> <p>Testing Manufactured to comply with ANSI/BIF-MA X5.4 Lounge Seating Tests.</p> <p>Environment Greenguard Certified.</p>

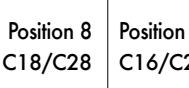
Yoom Rolled

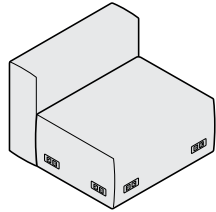
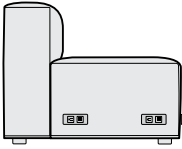
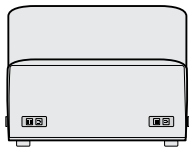
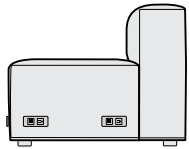
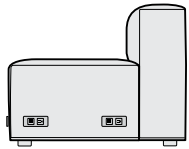
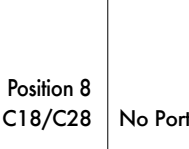
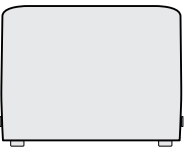
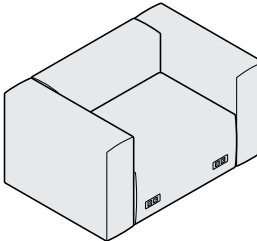
Power Port Options

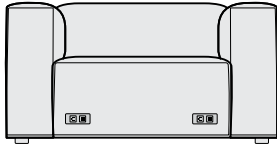
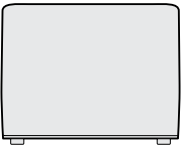
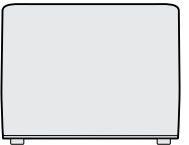
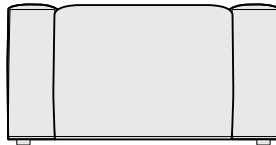
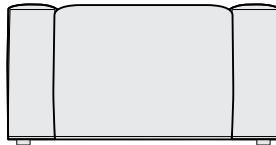
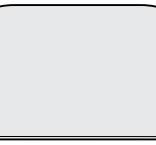
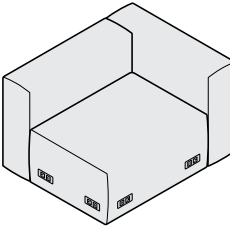
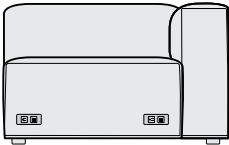
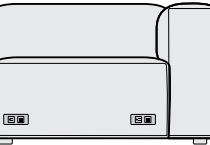
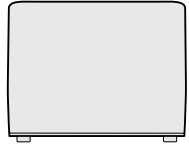
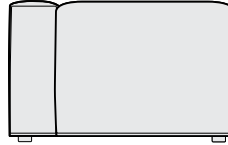
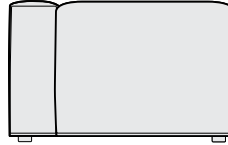
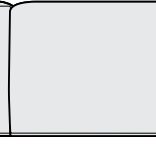
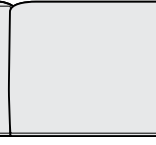
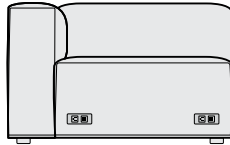
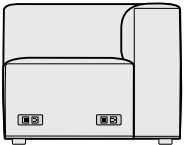
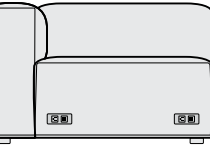
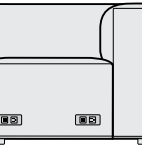
Modular Lounge Systems

	Right Side	Front	Left Side	Back	General Information				
Single Seat Power Port Option(s)	 Position 5 C15/C25	 Position 4 C14/C24	 Position 3 C13/C23	 Position 2 C12/C22	 Position 1 C11/C21	 Position 8 C18/C28	 Position 6 C16/C26	 Position 7 C17/C27	<p>In-Seat Power Ports With 10' Or 20' Cord</p> <p>Power Port Cord Length and Harness End C1X has a 10' power cord w/ NEMA 5-15P C2X has a 20' Power cord w/ NEMA 5-15P W1X 12' BX whip (for hardwiring) W1X 24' BX whip (for hardwiring)</p> <p>Power Port Location The power port location is determined by its last digit.</p> <p>Examples:</p> <ul style="list-style-type: none"> A C14 power port has a 10' power cord and is located on the right side of a chair, as determined from a seated position, or the right forward position of a bench. A C21 power port has a 20' power cord and is located on the left side of a chair, as determined from a seated position, or the left forward position of a bench. <p>Multiple power ports may be ordered per unit. The pricing shown is for each power port ordered.</p> <p>In-Seat Power Port Finish Select power port finish from one of the standard Stylex powder paints.</p> <p>Power In Chairs And Benches Power receptacle offers three exposed power ports: 2 USB 2.1A ports and a standard, grounded 3-prong electrical outlet.</p>
Single Chair Power Port Option(s)	 Position 5 C15/C25	 Position 4 C14/C24	 Position 3 C13/C23	 Position 2 C12/C22	 Position 1 C11/C21	 Position 8 C18/C28	No Ports		
Chair w/Arms Power Port Option(s)	 No Ports	 No Ports	 Position 3 C13/C23	 Position 2 C12/C22	 No Ports	 No Ports	 No Ports		
Single Chair w/Left Arm Power Port Option(s)	 Position 5 C15/C25	 Position 4 C14/C24	 Position 3 C13/C23	 Position 2 C12/C22	 No Ports	 No Ports	 No Ports		
Single Chair w/Right Arm Power Port Option(s)	 No Ports	 No Ports	 Position 3 C13/C23	 Position 2 C12/C22	 Position 1 C11/C21	 Position 8 C18/C28	 No Ports		

Power Port Ordering

Options-Power Port Configuration

Length and Harness End
C1X 10' cord length w/ NEMA 5-15P
C2X 20' cord length w/ NEMA 5-15P
W1X 12' BX whip (for hardwiring)
W1X 24' BX whip (for hardwiring)

Option Power Port Position
Position 1 thru 8
See above for power port location restrictions.

Option Power Port Finish

BM Black Matte	GR Green	OR Orange
BT Black Twilight	LB Light Bronze	RD Red
BL Blue	LG Light Gray	ST Sterling
BR Brass	MF Metallic Fieldstone	TP Taupe
CP Champagne	MS Metallic Silver	TS Textured Slate
DB Dark Bronze	MK Milk	TI Titanium
DC Dark Chocolate	NK Nickel	YL Yellow

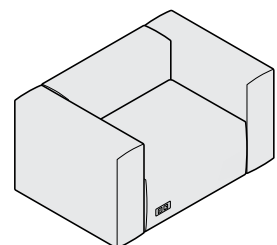

Example: C2 3 BM

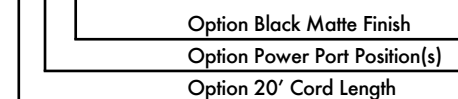

Option Black Matte Finish
Option Power Port Position(s)
Option 20' Cord Length

Yoom Rolled

Product Information Applications - Rolled Side

Modular Lounge Systems

Double Seat - Rolled Side

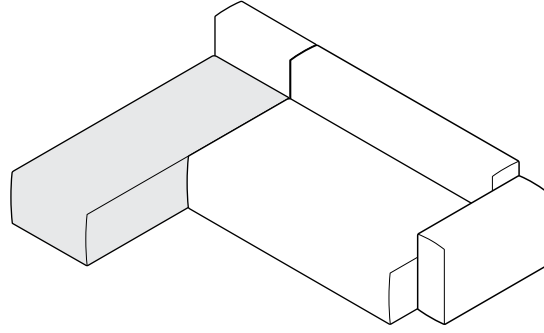

Double Full Seat - Rolled Side

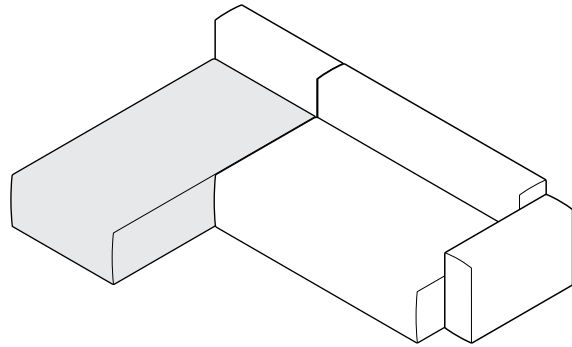

Chaise Right - Rolled Side

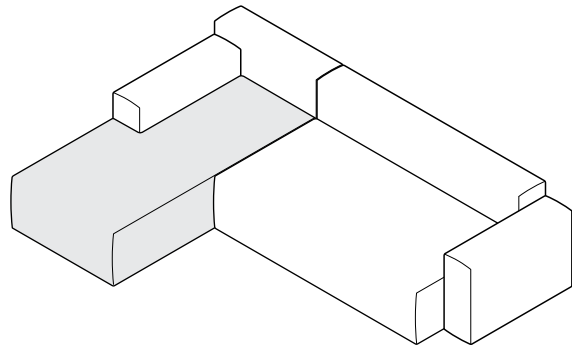

Rolled Side

The option of a 'Rolled Side' is offered on Double Seats, Double Full Seats, Chaise Right, and Chaise Left units capping the end of a layout. Seam direction is altered from the standard 'Rolled Front' for a consistent pattern with adjacent seats. This enables striped and patterned fabrics to line up across units.

Please refer to the sample layouts on this page as a reference for each 'Rolled Side' unit.

Selection of rolled side units will be reviewed and suggested by Stylex per customer layout. Refer to page 8 for pricing information.

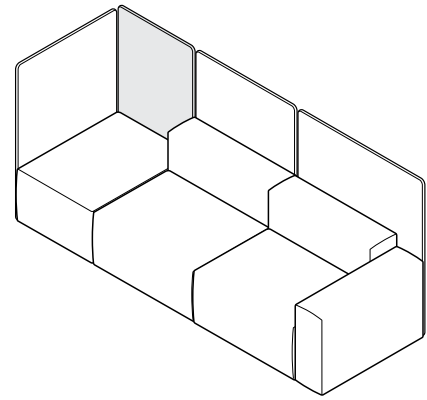

YM061 - Privacy Screen (25")

Privacy Screens

Yoom Privacy Screens are field installed and can be installed on seats, backs and arms. They can be used to provide privacy and definition to the space or can be directly used as a back with throw pillows in lieu of the traditional Yoom Backs or Back to Backs. Three different privacy screen widths have been created to keep pace with the specifiers creativity.

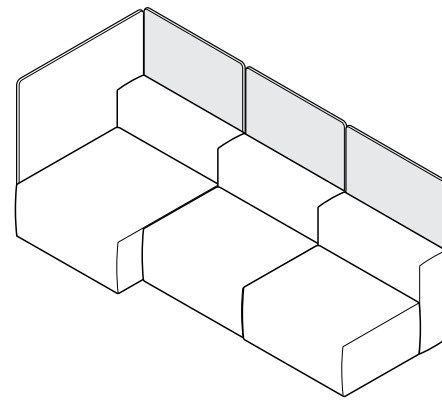
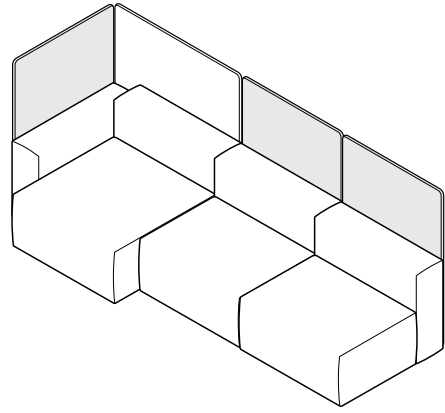
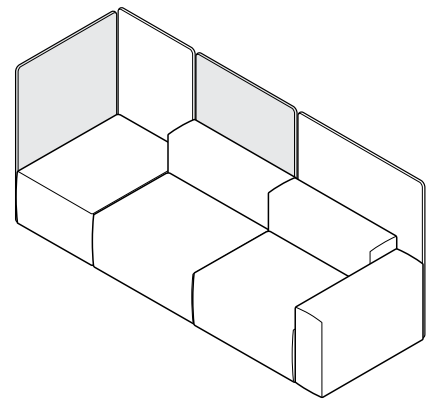

YM062 - Privacy Screens (34")

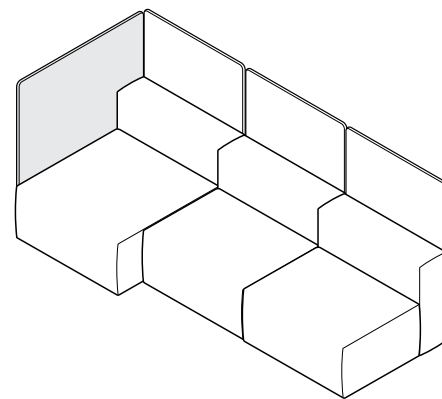
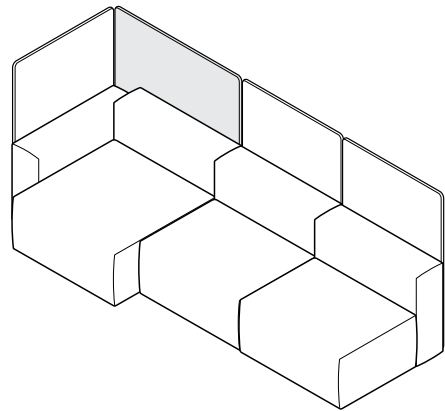
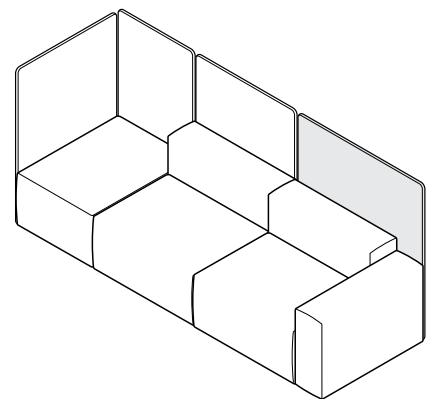

YM063 - Privacy Screens (43")

Yoom Rolled - A La Carte

Single Seat

Modular Lounge Systems

C.O.M.

C.O.M.
Fabric Upholstery
Grades

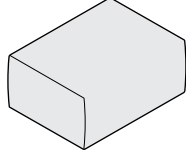
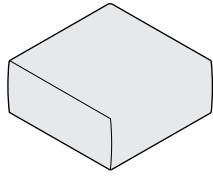
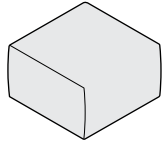
Series	Style	Type	Description	Ydg.	C.O.M.	A	B	C	D	E	F	G	H	I	J	K	L	M	
	YM	8	11	Single Seat Rolled Front Depth 25" Height 15" Width 34"	2.5	1,134	1,269	1,344	1,415	1,488	1,562	1,643	1,724	1,819	1,942	2,089	2,237	2,381	2,528
	YM	8	12	Single Full Seat Rolled Front Depth 34" Height 15" Width 34"	3.3	1,350	1,535	1,635	1,732	1,833	1,933	2,043	2,154	2,283	2,452	2,652	2,853	3,051	3,252
	YM	8	13	Single Narrow Seat Rolled Front Depth 25" Height 15" Width 25"	2.0	918	1,029	1,089	1,147	1,207	1,268	1,334	1,400	1,477	1,579	1,700	1,820	1,939	2,060

To Order follow steps 1-7

1 Series/Style	2 Type	3 Seam Option	4 Decorative Stitch Colors	5 Glides/Casters/Legs	6 Options	7 Fabrics
<p>YM8 Yoom Rolled Front</p>	<p>11 Single Seat</p> <p>12 Single Full Seat</p> <p>13 Single Narrow Seat</p>	<p>Seam Option</p> <p>SS Single seam on all edges +00</p> <p>SP Pinch seam on top edges +00</p> <p>Single seam on side edges</p> <p>SW Standard welt cord on all edges +10% of COM List</p>	<p>Decorative Stitch Color</p> <p>01 White</p> <p>02 Natural</p> <p>03 Lemon</p> <p>04 Pebble Beige</p> <p>05 Dk Mahogany</p> <p>06 Orange</p> <p>07 Red</p> <p>08 Purple</p> <p>09 Pro Blue</p> <p>10 Navy</p> <p>11 Olive</p> <p>12 Dark Green</p> <p>13 Nickel</p> <p>14 Dark Gray</p> <p>15 Black</p>	<p>Glide Options</p> <p>PG Plastic Glide +00 Recommended for easier movement on carpet.</p> <p>FG Felt Glide +00 Recommended for easier movement on hard floors.</p> <p>RG Rubber Glides +00 Recommended for static positioning.</p> <p>Caster Options</p> <p>CH Hard Wheel Caster +65 Recommended for full mobility in collaborative settings.</p> <p>CS Soft Wheel Caster +65 Recommended for full mobility in collaborative settings.</p> <p>L1 Round Legs +112 Legs increase seating height by 2". All standard Stylex powder paints and Polished Aluminum are available leg finish choices.</p>	<p>G Ganging +00</p> <p>C1X In-seat power port with 10' power cord +337</p> <p>C2X In-seat power port with 20' power cord +393</p> <p>W1X 12' BX whip (for hardwiring) +674</p> <p>W2X 24' BX whip (for hardwiring) +786</p> <p>See Page 6 for complete information on specifying power ports.</p>	<p>Yoom Rolled fabrics must be cut up the roll.</p> <p>Yoom Rolled is designed to have a casual look and feel. It is meant to show wrinkling with most fabrics.</p> <p>Refer to Stylex swatch cards and separately published in-graded fabric program to determine grades.</p> <p>See General Information section in the main price list for CAL 133 Information.</p>

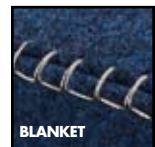

- Decorative Stitch on all edges (available on woven textiles only)**
- SSD1 Blanket stitch over single seam +10% of COM List
 - SSD2 Zig Zag stitch over single seam +10% of COM List
 - SSD3 Bowtie stitch over single seam +10% of COM List

Thread color must be specified.
Reference Stylex/Stitching on Stylexseating.com for thread colors and stitch images.

Yoom Rolled - A La Carte

Rolled Side - Double Seat/Chaise

Modular Lounge Systems

C.O.M.

C.O.M.
Fabric Upholstery
Grades

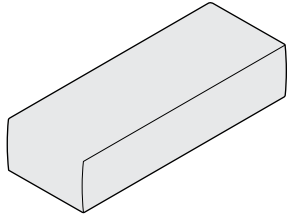
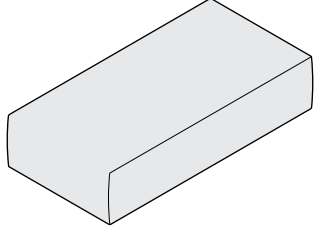
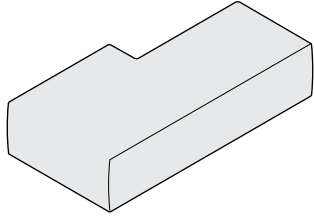
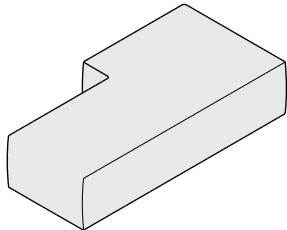
Series	Style	Type	Description	Ydg.	C.O.M.	A	B	C	D	E	F	G	H	I	J	K	L	M	
	YM	7	14	Double Seat Rolled Side Depth 25" Height 15" Width 68"	5.5	1,890	2,198	2,365	2,527	2,695	2,862	3,046	3,229	3,445	3,726	4,061	4,396	4,725	5,060
	YM	7	15	Double Full Seat Rolled Side Depth 34" Height 15" Width 68"	5.5	2,322	2,630	2,797	2,959	3,127	3,294	3,478	3,661	3,877	4,158	4,493	4,828	5,157	5,492
	YM	7	16	Chaise Right Rolled Side Depth 34"/25" Height 15" Width 68"	5.5	2,322	2,630	2,797	2,959	3,127	3,294	3,478	3,661	3,877	4,158	4,493	4,828	5,157	5,492
	YM	7	17	Chaise Left Rolled Side Depth 34"/25" Height 15" Width 68"	5.5	2,322	2,630	2,797	2,959	3,127	3,294	3,478	3,661	3,877	4,158	4,493	4,828	5,157	5,492

To Order follow steps 1-7

1 Series/Style 2 Type 3 Seam Option 4 Decorative Stitch Colors 5 Glides/Casters/Legs 6 Options 7 Fabrics

<p>1 Series/Style</p> <p>YM7 Yoom Rolled Side</p>	<p>2 Type</p> <p>14 Double Seat 15 Double Full Seat 16 Chaise Right 17 Chaise Left</p>	<p>3 Seam Option</p> <p>SS Single seam on all edges +00 SP Pinch seam on top edges +00 SW Standard welt cord on all edges +10% of COM List</p> <p>Decorative Stitch on all edges (available on woven textiles only)</p> <p>SSD1 Blanket stitch over single seam +10% of COM List SSD2 Zig Zag stitch over single seam +10% of COM List SSD3 Bowtie stitch over single seam +10% of COM List</p> <p>Thread color must be specified. Reference Stylex/Stitching on Stylexseating.com for thread colors and stitch images.</p>	<p>4 Decorative Stitch Colors</p> <p>01 White 02 Natural 03 Lemon 04 Pebble Beige 05 Dk Mahogany 06 Orange 07 Red 08 Purple 09 Pro Blue 10 Navy 11 Olive 12 Dark Green 13 Nickel 14 Dark Gray 15 Black</p>	<p>5 Glides/Casters/Legs</p> <p>PG Plastic Glide +00 Recommended for easier movement on carpet.</p> <p>FG Felt Glide +00 Recommended for easier movement on hard floors.</p> <p>RG Rubber Glides +00 Recommended for static positioning.</p> <p>L1 Round Legs +112 Legs increase seating height by 2". All standard Stylex powder paints and Polished Aluminum are available leg finish choices.</p>	<p>6 Options</p> <p>G Ganging +00</p> <p>C1X In-seat power port with 10' power cord +337</p> <p>C2X In-seat power port with 20' power cord +393</p> <p>W1X 12' BX whip (for hardwiring) +674</p> <p>W2X 24' BX whip (for hardwiring) +786</p> <p>See Page 6 for complete information on specifying power ports.</p>	<p>7 Fabrics</p> <p>Yoom Rolled fabrics must be cut up the roll.</p> <p>Yoom Rolled is designed to have a casual look and feel. It is meant to show wrinkling with most fabrics.</p> <p>Refer to Stylex swatch cards and separately published in-graded fabric program to determine grades.</p> <p>See General Information section in the main price list for CAL 133 Information.</p>
--	---	---	---	--	--	--

Yoom Rolled - A La Carte

Double Seat/Chaise

Modular Lounge Systems

C.O.M.

C.O.M.
Fabric Upholstery
Grades

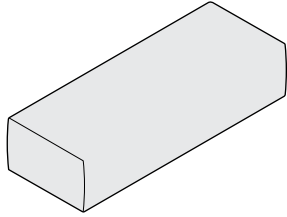
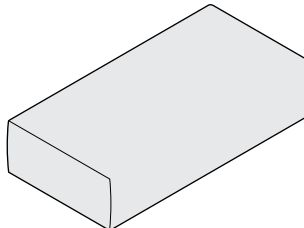
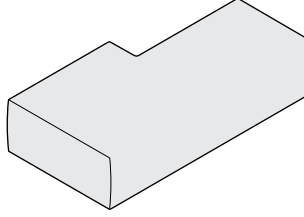
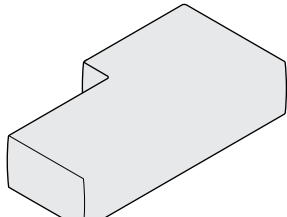
Series	Style	Type	Description	Ydg.	C.O.M.	A	B	C	D	E	F	G	H	I	J	K	L	M	
	YM	8	14	Double Seat Rolled Front Depth 25" Height 15" Width 68"	4.3	1,890	2,130	2,260	2,387	2,517	2,648	2,792	2,934	3,103	3,322	3,583	3,845	4,102	4,362
	YM	8	15	Double Full Seat Rolled Front Depth 34" Height 15" Width 68"	4.3	2,322	2,562	2,692	2,819	2,949	3,080	3,224	3,366	3,535	3,754	4,015	4,277	4,534	4,794
	YM	8	16	Chaise Right Rolled Front Depth 34"/25" Height 15" Width 68"	5.0	2,322	2,605	2,759	2,908	3,062	3,216	3,385	3,554	3,753	4,011	4,319	4,627	4,930	5,238
	YM	8	17	Chaise Left Rolled Front Depth 34"/25" Height 15" Width 68"	5.0	2,322	2,605	2,759	2,908	3,062	3,216	3,385	3,554	3,753	4,011	4,319	4,627	4,930	5,238

To Order follow steps 1-7

1 Series/Style	2 Type	3 Seam Option	4 Decorative Stitch Colors	5 Glides/Casters/Legs	6 Options	7 Fabrics
<p>YM8 Yoom Rolled Front</p>	<p>14 Double Seat</p> <p>15 Double Full Seat</p> <p>16 Chaise Right</p> <p>17 Chaise Left</p>	<p>Seam Option</p> <p>SS Single seam on all edges +00</p> <p>SP Pinch seam on top edges +00</p> <p>Single seam on side edges</p> <p>SW Standard welt cord on all edges +10% of COM List</p>	<p>Decorative Stitch Color</p> <p>01 White</p> <p>02 Natural</p> <p>03 Lemon</p> <p>04 Pebble Beige</p> <p>05 Dk Mahogany</p> <p>06 Orange</p> <p>07 Red</p> <p>08 Purple</p> <p>09 Pro Blue</p> <p>10 Navy</p> <p>11 Olive</p> <p>12 Dark Green</p> <p>13 Nickel</p> <p>14 Dark Gray</p> <p>15 Black</p>	<p>Glide Options</p> <p>PG Plastic Glide +00 Recommended for easier movement on carpet.</p> <p>FG Felt Glide +00 Recommended for easier movement on hard floors.</p> <p>RG Rubber Glides +00 Recommended for static positioning.</p> <p>L1 Round Legs +112 Legs increase seating height by 2". All standard Stylex powder paints and Polished Aluminum are available leg finish choices.</p>	<p>G Ganging +00</p> <p>C1X In-seat power port with 10' power cord +337</p> <p>C2X In-seat power port with 20' power cord +393</p> <p>W1X 12' BX whip (for hardwiring) +674</p> <p>W2X 24' BX whip (for hardwiring) +786</p> <p>See Page 6 for complete information on specifying power ports.</p>	<p>Yoom Rolled fabrics must be cut up the roll.</p> <p>Yoom Rolled is designed to have a casual look and feel. It is meant to show wrinkling with most fabrics.</p> <p>Refer to Stylex swatch cards and separately published in-graded fabric program to determine grades.</p> <p>See General Information section in the main price list for CAL 133 Information.</p>



Decorative Stitch on all edges (available on woven textiles only)

SSD1 Blanket stitch over single seam +10% of COM List

SSD2 Zig Zag stitch over single seam +10% of COM List

SSD3 Bowtie stitch over single seam +10% of COM List

Thread color must be specified.
Reference Stylex/Stitching on Stylexseating.com for thread colors and stitch images.

Yoom Rolled - A La Carte

Single Backs

Modular Lounge Systems

C.O.M.

C.O.M.
Fabric Upholstery
Grades

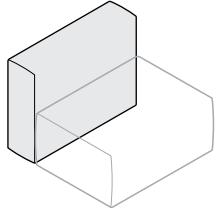
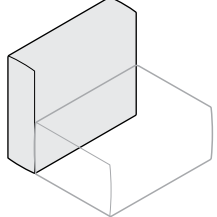
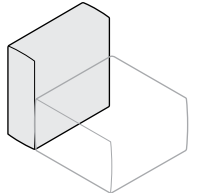
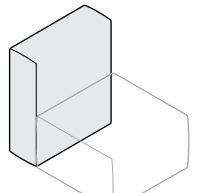
Series	Style	Type	Description	Ydg.	C.O.M.	A	B	C	D	E	F	G	H	I	J	K	L	M	
	YM	8	31	Single Back Rolled Front Depth 9" Height 26" Width 34"	2.1	648	765	828	890	954	1,017	1,088	1,157	1,239	1,346	1,473	1,601	1,726	1,852
	YM	8	32	Single High Back Rolled Front Depth 9" Height 30" Width 34"	2.3	702	832	902	970	1,040	1,110	1,187	1,265	1,355	1,473	1,614	1,754	1,893	2,034
	YM	8	33	Single Narrow Back Rolled Front Depth 9" Height 26" Width 25"	2.1	594	711	774	836	900	963	1,034	1,103	1,185	1,292	1,419	1,547	1,672	1,798
	YM	8	38	Single Narrow High Back Rolled Front Depth 9" Height 30" Width 25"	1.9	702	800	854	906	959	1,013	1,072	1,131	1,200	1,290	1,397	1,504	1,609	1,716

To Order follow steps 1-5

1 Series/Style	2 Type	3 Seam Option	4 Decorative Stitch Colors	5 Fabrics
<p>YM8</p> <p>YMB Yoom Rolled Front</p>	<p>31 Single Back</p> <p>32 Single High Back</p> <p>33 Single Narrow Back</p> <p>38 Single Narrow High Back</p>	<p>Seam Option</p> <p>SS Single seam on all edges +00</p> <p>SP Pinch seam on top edges +00</p> <p>Single seam on side edges</p> <p>SW Standard welt cord on all edges +10% of COM List</p> <p>Decorative Stitch on all edges (available on woven textiles only)</p> <p>SSD1 Blanket stitch over single seam +10% of COM List</p> <p>SSD2 Zig Zag stitch over single seam +10% of COM List</p> <p>SSD3 Bowtie stitch over single seam +10% of COM List</p> <p>Thread color must be specified. Reference Stylex/Stitching on Stylexseating.com for thread colors and stitch images.</p>	<p>Decorative Stitch Color</p> <p>01 White</p> <p>02 Natural</p> <p>03 Lemon</p> <p>04 Pebble Beige</p> <p>05 Dk Mahogany</p> <p>06 Orange</p> <p>07 Red</p> <p>08 Purple</p> <p>09 Pro Blue</p> <p>10 Navy</p> <p>11 Olive</p> <p>12 Dark Green</p> <p>13 Nickel</p> <p>14 Dark Gray</p> <p>15 Black</p>	<p>Yoom Rolled fabrics must be cut up the roll.</p> <p>Yoom Rolled is designed to have a casual look and feel. It is meant to show wrinkling with most fabrics.</p> <p>Refer to Stylex swatch cards and separately published in-graded fabric program to determine grades .</p> <p>See General Information section in the main price list for CAL 133 Information.</p>



Yoom Rolled - A La Carte

Single Backs

Modular Lounge Systems

C.O.M.

C.O.M.
Fabric Upholstery
Grades

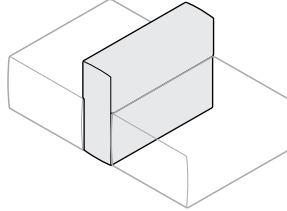
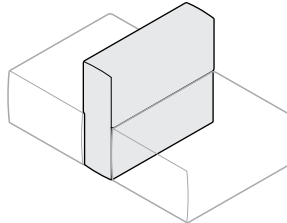
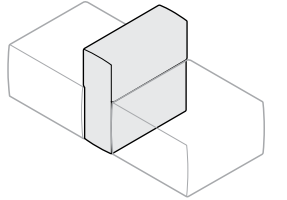
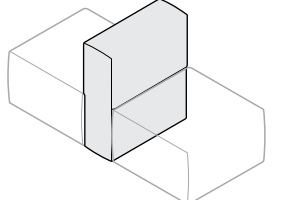
Series	Style	Type	Description	Ydg.	C.O.M.	A	B	C	D	E	F	G	H	I	J	K	L	M	W	X	Y	E1	E2
	YM	8	39	Single Thin Back to Back Rolled Front Depth 9" Height 26" Width 34"	2.1	756	873	937	998	1,062	1,125	1,195	1,265	1,347	1,454	1,581	1,708	1,833	1,961				
	YM	8	40	Single High Thin Back to Back Rolled Front Depth 9" Height 30" Width 34"	2.2	864	987	1,054	1,119	1,186	1,253	1,326	1,400	1,486	1,598	1,732	1,866	1,998	2,132				
	YM	8	41	Single Narrow Thin Back to Back Rolled Front Depth 9" Height 26" Width 25"	1.6	756	842	889	934	981	1,028	1,080	1,131	1,191	1,270	1,364	1,458	1,550	1,644				
	YM	8	42	Single Narrow High Thin Back to Back Rolled Front Depth 9" Height 30" Width 25"	1.8	864	962	1,016	1,068	1,121	1,175	1,234	1,293	1,362	1,452	1,559	1,666	1,771	1,878				

To Order follow steps 1-5

1 Series/Style	2 Type	3 Seam Option	4 Decorative Stitch Colors	5 Fabrics
<p>YM8</p> <p>YMB Yoom Rolled Front</p>	<p>39 Single Thin Back to Back</p> <p>40 Single High Thin Back to Back</p> <p>41 Single Narrow Thin Back to Back</p> <p>42 Single Narrow High Thin Back to Back</p>	<p>Seam Option</p> <p>SS Single seam on all edges +00</p> <p>SP Pinch seam on top edges +00</p> <p>Single seam on side edges</p> <p>SW Standard welt cord on all edges +10% of COM List</p> <p>Decorative Stitch on all edges (available on woven textiles only)</p> <p>SSD1 Blanket stitch over single seam +10% of COM List</p> <p>SSD2 Zig Zag stitch over single seam +10% of COM List</p> <p>SSD3 Bowtie stitch over single seam +10% of COM List</p> <p>Thread color must be specified. Reference Stylex/Stitching on Stylexseating.com for thread colors and stitch images.</p>	<p>Decorative Stitch Color</p> <p>01 White</p> <p>02 Natural</p> <p>03 Lemon</p> <p>04 Pebble Beige</p> <p>05 Dk Mahogany</p> <p>06 Orange</p> <p>07 Red</p> <p>08 Purple</p> <p>09 Pro Blue</p> <p>10 Navy</p> <p>11 Olive</p> <p>12 Dark Green</p> <p>13 Nickel</p> <p>14 Dark Gray</p> <p>15 Black</p>	<p>Yoom Rolled fabrics must be cut up the roll.</p> <p>Yoom Rolled is designed to have a casual look and feel. It is meant to show wrinkling with most fabrics.</p> <p>Refer to Stylex swatch cards and separately published in-graded fabric program to determine grades .</p> <p>See General Information section in the main price list for CAL 133 Information.</p>

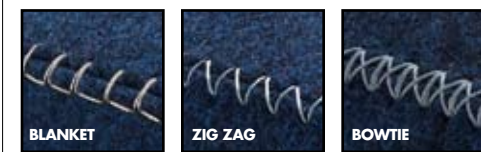

Yoom Rolled - A La Carte

Double Backs

Modular Lounge Systems

C.O.M.

C.O.M.
Fabric Upholstery
Grades

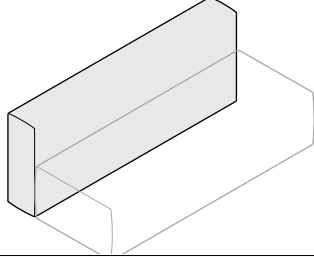
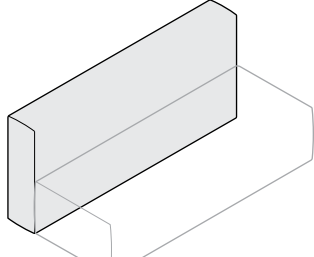
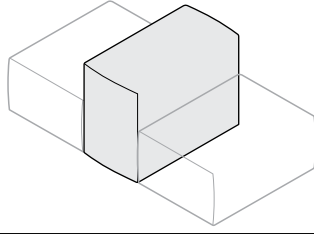
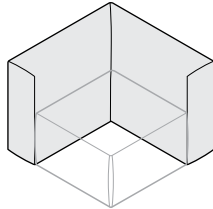
Series	Style	Type	Description	Ydg.	C.O.M.	A	B	C	D	E	F	G	H	I	J	K	L	M	
	YM	8	34	Double Back Rolled Front Depth 9" Height 26" Width 68"	4.1	1,188	1,416	1,540	1,660	1,783	1,907	2,043	2,179	2,339	2,547	2,794	3,042	3,286	3,534
	YM	8	35	Double High Back Rolled Front Depth 9" Height 30" Width 68"	4.7	1,350	1,608	1,750	1,886	2,026	2,166	2,321	2,475	2,657	2,892	3,173	3,455	3,731	4,012
	YM	8	36	Back to Back Rolled Front Depth 18" Height 26" Width 34"	3.2	864	1,042	1,139	1,233	1,331	1,428	1,535	1,641	1,766	1,929	2,123	2,318	2,509	2,702
	YM	8	37	Corner Back Rolled Front Depth 34" Height 26" Width 34"	3.3	972	1,163	1,267	1,367	1,471	1,575	1,688	1,803	1,936	2,110	2,318	2,525	2,730	2,938

To Order follow steps 1-5

1 Series/Style 2 Type 3 Seam Option 4 Decorative Stitch Colors 5 Fabrics

YM8

YMB Yoom Rolled Front

34

Double Back

35

Double High Back

36

Back to Back

37

Corner Back

Seam Option

SS Single seam on all edges +00

SP Pinch seam on top edges +00

SW Standard welt cord on all edges +10% of COM List

Decorative Stitch on all edges (available on woven textiles only)



SSD1 Blanket stitch over single seam +10% of COM List

SSD2 Zig Zag stitch over single seam +10% of COM List

SSD3 Bowtie stitch over single seam +10% of COM List

Thread color must be specified.
Reference Stylex/Stitching on Stylexseating.com for thread colors and stitch images.

Decorative Stitch Color

01 White

02 Natural

03 Lemon

04 Pebble Beige

05 Dk Mahogany

06 Orange

07 Red

08 Purple

09 Pro Blue

10 Navy

11 Olive

12 Dark Green

13 Nickel

14 Dark Gray

15 Black

Yoom Rolled fabrics must be cut up the roll.

Yoom Rolled is designed to have a casual look and feel. It is meant to show wrinkling with most fabrics.

Refer to Stylex swatch cards and separately published in-graded fabric program to determine grades.

See General Information section in the main price list for CAL 133 Information.

Yoom Rolled - A La Carte

Arm and Privacy Screens

Modular Lounge Systems

C.O.M.

C.O.M.
Fabric Upholstery
Grades

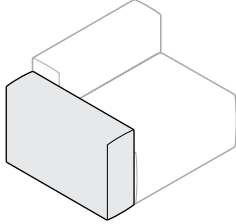
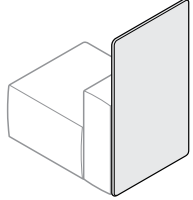
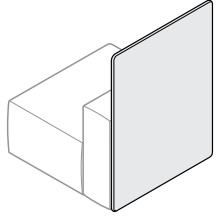
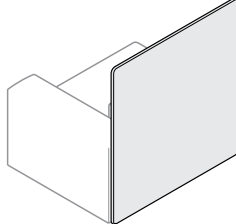
Series	Style	Type	Description	Ydg.	C.O.M.	A	B	C	D	E	F	G	H	I	J	K	L	M	W	X	Y	E1	E2
	YM	8	51	Single Low Arm Rolled Front Depth 9" Height 22" Width 34"	1.9	540	645	702	757	813	870	933	996	1,069	1,164	1,278	1,392	1,504	1,618				
	YM	0	61	25" Privacy Screen Depth 1.5" Height 45" Width 25"	2.2	756	879	946	1,011	1,078	1,145	1,218	1,292	1,378	1,490	1,624	1,758	1,890	2,024				
	YM	0	62	34" Privacy Screen Depth 1.5" Height 45" Width 34"	3.0	972	1,138	1,229	1,316	1,406	1,497	1,596	1,695	1,812	1,963	2,144	2,325	2,503	2,684				
	YM	0	63	43" Privacy Screen Depth 1.5" Height 45" Width 43"	3.8	1,188	1,397	1,511	1,621	1,735	1,849	1,974	2,099	2,246	2,436	2,664	2,892	3,116	3,343				

To Order follow steps 1-5

1 Series/Style	2 Type	3 Seam Option	4 Decorative Stitch Colors	5 Fabrics
<p>YM</p> <p>YM Yoom Rolled Front</p>	<p>551 Single Low Arm</p> <p>061 25" Privacy Screen</p> <p>062 34" Privacy Screen</p> <p>063 43" Privacy Screen</p>	<p>Seam Option</p> <p>SS Single seam on all edges +00</p> <p>SP Pinch seam on top edges* +00</p> <p>Single seam on side edges</p> <p>SW Standard welt cord on all edges* +10% of COM List</p>	<p>Decorative Stitch Color</p> <p>01 White</p> <p>02 Natural</p> <p>03 Lemon</p> <p>04 Pebble Beige</p> <p>05 Dk Mahogany</p> <p>06 Orange</p> <p>07 Red</p> <p>08 Purple</p> <p>09 Pro Blue</p> <p>10 Navy</p> <p>11 Olive</p> <p>12 Dark Green</p> <p>13 Nickel</p> <p>14 Dark Gray</p> <p>15 Black</p>	<p>Yoom Rolled fabrics must be cut up the roll.</p> <p>Yoom Rolled is designed to have a casual look and feel. It is meant to show wrinkling with most fabrics.</p> <p>Refer to Stylex swatch cards and separately published in-graded fabric program to determine grades .</p> <p>See General Information section in the main price list for CAL 133 Information.</p>
		<p>Decorative Stitch on all edges (available on woven textiles only)*</p> <p>SSD1 Blanket stitch over single seam +10% of COM List</p> <p>SSD2 Zig Zag stitch over single seam +10% of COM List</p> <p>SSD3 Bowtie stitch over single seam +10% of COM List</p> <p>Thread color must be specified. Reference Stylex/Stitching on Stylexseating.com for thread colors and stitch images.</p> <p>*Not applicable w/privacy screens.</p>		



Yoom Rolled

Single Chairs

Modular Lounge Systems

C.O.M.

C.O.M.
Fabric Upholstery
Grades

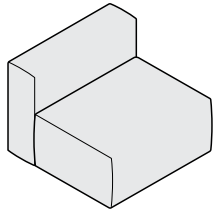
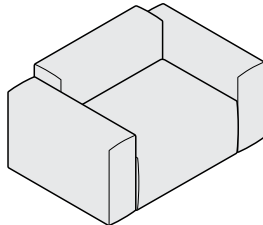
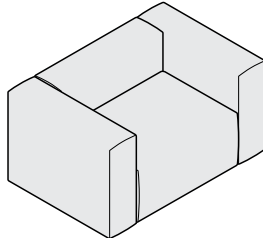
Series	Style	Type	Description	Ydg.	C.O.M.	A	B	C	D	E	F	G	H	I	J	K	L	M
	YM	8	Single Chair Armless Rolled Front Depth 34" Height 26" Seat Height 15" Width 34"	4.4	1,782	2,028	2,162	2,292	2,426	2,560	2,706	2,853	3,026	3,251	3,519	3,786	4,050	4,318
	YM	8	Single Chair with Low Arms Rolled Front Depth 34" Height 26" Seat Height 15" Arm Height 22" Width 52"	8.0	2,862	3,311	3,555	3,792	4,037	4,281	4,549	4,817	5,132	5,543	6,032	6,520	7,002	7,490
	YM	8	Single Chair with High Arms Rolled Front Depth 34" Height 26" Seat Height 15" Arm Height 26" Width 52"	8.5	3,078	3,552	3,810	4,060	4,317	4,575	4,858	5,141	5,473	5,905	6,421	6,937	7,444	7,960

To Order follow steps 1-7

1 Series/Style	2 Type	3 Seam Option	4 Decorative Stitch Colors	5 Glides/Casters/Legs	6 Options	7 Fabrics
<p>YMB Yoom Rolled Front</p> <p>113100 Single Chair Armless</p> <p>113151P Single Chair with Low Arms</p> <p>113131P Single Chair with High Arms</p>		<p>Seam Option</p> <p>SS Single seam on all edges +00</p> <p>SP Pinch seam on top edges +00</p> <p>Single seam on side edges</p> <p>SW Standard welt cord on all edges +10% of COM List</p>	<p>Decorative Stitch Color</p> <p>01 White</p> <p>02 Natural</p> <p>03 Lemon</p> <p>04 Pebble Beige</p> <p>05 Dk Mahogany</p> <p>06 Orange</p> <p>07 Red</p> <p>08 Purple</p> <p>09 Pro Blue</p> <p>10 Navy</p> <p>11 Olive</p> <p>12 Dark Green</p> <p>13 Nickel</p> <p>14 Dark Gray</p> <p>15 Black</p>	<p>Glide Options</p> <p>PG Plastic Glide +00 Recommended for easier movement on carpet.</p> <p>FG Felt Glide +00 Recommended for easier movement on hard floors.</p> <p>RG Rubber Glides +00 Recommended for static positioning.</p> <p>Caster Options</p> <p>CH Hard Wheel Caster +65 Recommended for full mobility in collaborative settings.</p> <p>CS Soft Wheel Caster +65 Recommended for full mobility in collaborative settings.</p> <p>L1 Round Legs +112 Legs increase seating height by 2". All standard Stylex powder paints and Polished Aluminum are available leg finish choices.</p>	<p>G Ganging +00</p> <p>C1X In-seat power port with 10' power cord +337</p> <p>C2X In-seat power port with 20' power cord +393</p> <p>W1X 12' BX whip (for hardwiring) +674</p> <p>W2X 24' BX whip (for hardwiring) +786</p> <p>See Page 6 for complete information on specifying power ports.</p>	<p>Yoom Rolled fabrics must be cut up the roll.</p> <p>Yoom Rolled is designed to have a casual look and feel. It is meant to show wrinkling with most fabrics.</p> <p>Refer to Stylex swatch cards and separately published in-graded fabric program to determine grades.</p> <p>See General Information section in the main price list for CAL 133 Information.</p>



Decorative Stitch on all edges (available on woven textiles only)

SSD1 Blanket stitch over single seam +10% of COM List

SSD2 Zig Zag stitch over single seam +10% of COM List

SSD3 Bowtie stitch over single seam +10% of COM List

Thread color must be specified.
Reference Stylex/Stitching on Stylexseating.com for thread colors and stitch images.

Yoom Rolled

Single Full Chairs

Modular Lounge Systems

C.O.M.

C.O.M.
Fabric Upholstery
Grades

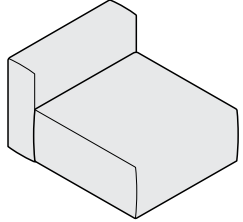
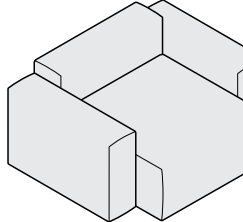
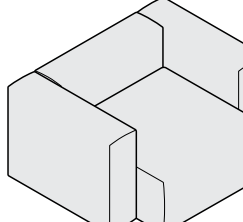
Series	Style	Type	Description	Ydg.	C.O.M.	A	B	C	D	E	F	G	H	I	J	K	L	M	
	YM	8	123100	Single Full Chair Armless Rolled Front Depth 43" Height 26" Seat Height 15" Width 34"	5.3	1,998	2,294	2,454	2,609	2,770	2,931	3,107	3,283	3,491	3,761	4,082	4,403	4,720	5,041
	YM	8	123151P	Single Full Chair with Low Arms Rolled Front Depth 43" Height 26" Seat Height 15" Arm Height 22" Width 52"	8.8	3,078	3,570	3,838	4,098	4,365	4,633	4,927	5,221	5,566	6,016	6,551	7,087	7,614	8,150
	YM	8	123131P	Single Full Chair with High Arms Rolled Front Depth 43" Height 26" Seat Height 15" Arm Height 26" Width 52"	9.4	3,294	3,818	4,102	4,377	4,662	4,946	5,259	5,571	5,938	6,415	6,984	7,554	8,114	8,683

To Order follow steps 1-7

1 Series/Style	2 Type	3 Seam Option	4 Decorative Stitch Colors	5 Glides/Casters/Legs	6 Options	7 Fabrics
<p>YM8 Yoom Rolled Front</p>	<p>123100 Single Full Chair Armless</p> <p>123151P Single Full Chair with Low Arms</p> <p>123131P Single Full Chair with High Arms</p>	<p>Seam Option</p> <p>SS Single seam on all edges +00</p> <p>SP Pinch seam on top edges +00</p> <p>Single seam on side edges</p> <p>SW Standard welt cord on all edges +10% of COM List</p> <p>Decorative Stitch on all edges (available on woven textiles only)</p> <p>SSD1 Blanket stitch over single seam +10% of COM List</p> <p>SSD2 Zig Zag stitch over single seam +10% of COM List</p> <p>SSD3 Bowtie stitch over single seam +10% of COM List</p> <p>Thread color must be specified. Reference Stylex/Stitching on Stylexseating.com for thread colors and stitch images.</p>	<p>Decorative Stitch Color</p> <p>01 White</p> <p>02 Natural</p> <p>03 Lemon</p> <p>04 Pebble Beige</p> <p>05 Dk Mahogany</p> <p>06 Orange</p> <p>07 Red</p> <p>08 Purple</p> <p>09 Pro Blue</p> <p>10 Navy</p> <p>11 Olive</p> <p>12 Dark Green</p> <p>13 Nickel</p> <p>14 Dark Gray</p> <p>15 Black</p>	<p>Glide Options</p> <p>PG Plastic Glide +00 Recommended for easier movement on carpet.</p> <p>FG Felt Glide +00 Recommended for easier movement on hard floors.</p> <p>RG Rubber Glides +00 Recommended for static positioning.</p> <p>Caster Options</p> <p>CH Hard Wheel Caster +65 Recommended for full mobility in collaborative settings.</p> <p>CS Soft Wheel Caster +65 Recommended for full mobility in collaborative settings.</p> <p>L1 Round Legs +112 Legs increase seating height by 2". All standard Stylex powder paints and Polished Aluminum are available leg finish choices.</p>	<p>G Ganging +00</p> <p>C1X In-seat power port with 10' power cord +337</p> <p>C2X In-seat power port with 20' power cord +393</p> <p>W1X 12' BX whip (for hardwiring) +674</p> <p>W2X 24' BX whip (for hardwiring) +786</p> <p>See Page 6 for complete information on specifying power ports.</p>	<p>Yoom Rolled fabrics must be cut up the roll.</p> <p>Yoom Rolled is designed to have a casual look and feel. It is meant to show wrinkling with most fabrics.</p> <p>Refer to Stylex swatch cards and separately published in-graded fabric program to determine grades .</p> <p>See General Information section in the main price list for CAL 133 Information.</p>



Yoom Rolled

Double Chairs

Modular Lounge Systems

C.O.M.

C.O.M.
Fabric Upholstery
Grades

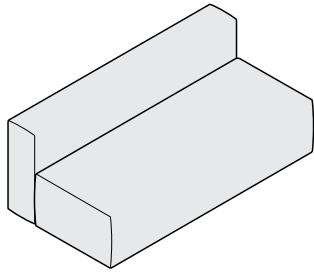
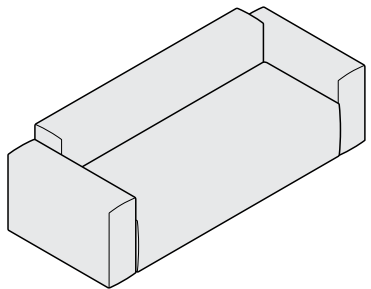
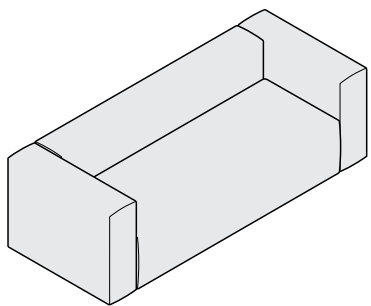
Series	Style	Type	Description	Ydg.	C.O.M.	A	B	C	D	E	F	G	H	I	J	K	L	M	
	YM	8	143400	Double Chair Armless Rolled Front Depth 34" Height 26" Seat Height 15" Width 68"	8.3	3,078	3,540	3,791	4,034	4,285	4,536	4,811	5,087	5,411	5,832	6,334	6,836	7,331	7,833
	YM	8	143451P	Double Chair with Low Arms Rolled Front Depth 34" Height 26" Seat Height 15" Arm Height 22" Width 86"	11.9	4,158	4,823	5,184	5,534	5,896	6,258	6,654	7,050	7,517	8,124	8,847	9,570	10,282	11,005
	YM	8	143431P	Double Chair with High Arms Rolled Front Depth 34" Height 26" Seat Height 15" Arm Height 26" Width 86"	12.3	4,374	5,063	5,439	5,802	6,177	6,551	6,963	7,374	7,858	8,487	9,236	9,987	10,724	11,474

To Order follow steps 1-7

1 Series/Style	2 Type	3 Seam Option	4 Decorative Stitch Colors	5 Glides/Casters/Legs	6 Options	7 Fabrics
<p>YMB Yoom Rolled Front</p>	<p>143400 Double Chair Armless</p> <p>143451P Double Chair with Low Arms</p> <p>143431P Double Chair with High Arms</p>	<p>Seam Option</p> <p>SS Single seam on all edges +00</p> <p>SP Pinch seam on top edges +00</p> <p>Single seam on side edges</p> <p>SW Standard welt cord on all edges +10% of COM List</p> <p>Decorative Stitch on all edges (available on woven textiles only)</p> <p>SSD1 Blanket stitch over single seam +10% of COM List</p> <p>SSD2 Zig Zag stitch over single seam +10% of COM List</p> <p>SSD3 Bowtie stitch over single seam +10% of COM List</p> <p>Thread color must be specified. Reference Stylex/Stitching on Stylexseating.com for thread colors and stitch images.</p>	<p>Decorative Stitch Color</p> <p>01 White</p> <p>02 Natural</p> <p>03 Lemon</p> <p>04 Pebble Beige</p> <p>05 Dk Mahogany</p> <p>06 Orange</p> <p>07 Red</p> <p>08 Purple</p> <p>09 Pro Blue</p> <p>10 Navy</p> <p>11 Olive</p> <p>12 Dark Green</p> <p>13 Nickel</p> <p>14 Dark Gray</p> <p>15 Black</p>	<p>Glide Options</p> <p>PG Plastic Glide +00 Recommended for easier movement on carpet.</p> <p>FG Felt Glide +00 Recommended for easier movement on hard floors.</p> <p>RG Rubber Glides +00 Recommended for static positioning.</p> <p>L1 Round Legs +112 Legs increase seating height by 2". All standard Stylex powder paints and Polished Aluminum are available leg finish choices.</p>	<p>G Ganging +00</p> <p>C1X In-seat power port with 10' power cord +337</p> <p>C2X In-seat power port with 20' power cord +393</p> <p>W1X 12' BX whip (for hardwiring) +674</p> <p>W2X 24' BX whip (for hardwiring) +786</p> <p>See Page 6 for complete information on specifying power ports.</p>	<p>Yoom Rolled fabrics must be cut up the roll.</p> <p>Yoom Rolled is designed to have a casual look and feel. It is meant to show wrinkling with most fabrics.</p> <p>Refer to Stylex swatch cards and separately published in-graded fabric program to determine grades .</p> <p>See General Information section in the main price list for CAL 133 Information.</p>



Yoom Rolled

Double Full Chairs

Modular Lounge Systems

C.O.M.

C.O.M.
Fabric Upholstery
Grades

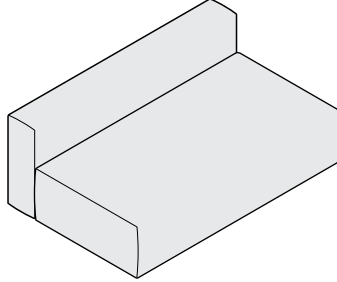
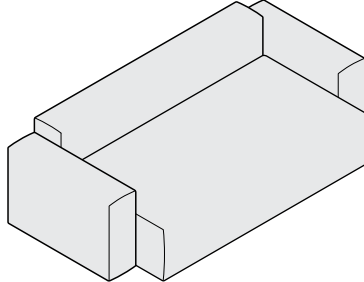
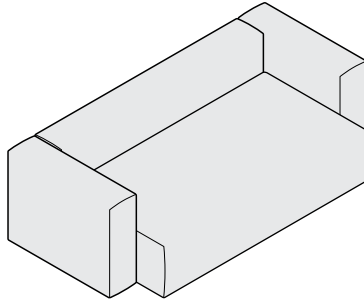
Series	Style	Type	Description	Ydg.	C.O.M.	A	B	C	D	E	F	G	H	I	J	K	L	M	
	YM	8	153400	Double Full Chair Armless Rolled Front Depth 43" Height 26" Seat Height 15" Width 68"	9.4	3,510	4,034	4,318	4,593	4,878	5,162	5,475	5,787	6,154	6,631	7,200	7,770	8,330	8,899
	YM	8	153451P	Double Full Chair with Low Arms Rolled Front Depth 43" Height 26" Seat Height 15" Arm Height 22" Width 86"	13.0	4,590	5,317	5,711	6,093	6,489	6,884	7,317	7,750	8,260	8,923	9,714	10,503	11,281	12,071
	YM	8	153431P	Double Full Chair with High Arms Rolled Front Depth 43" Height 26" Seat Height 15" Arm Height 26" Width 86"	13.5	4,806	5,557	5,966	6,361	6,769	7,178	7,626	8,074	8,601	9,286	10,102	10,920	11,723	12,540

To Order follow steps 1-7

1 Series/Style	2 Type	3 Seam Option	4 Decorative Stitch Colors	5 Glides/Casters/Legs	6 Options	7 Fabrics
<p>YMB Yoom Rolled Front</p>	<p>153400 Double Full Chair Armless</p> <p>153451P Double Full Chair with Low Arms</p> <p>153431P Double Full Chair with High Arms</p>	<p>Seam Option</p> <p>SS Single seam on all edges +00</p> <p>SP Pinch seam on top edges +00</p> <p>Single seam on side edges</p> <p>SW Standard welt cord on all edges +10% of COM List</p>	<p>Decorative Stitch Color</p> <p>01 White</p> <p>02 Natural</p> <p>03 Lemon</p> <p>04 Pebble Beige</p> <p>05 Dk Mahogany</p> <p>06 Orange</p> <p>07 Red</p> <p>08 Purple</p> <p>09 Pro Blue</p> <p>10 Navy</p> <p>11 Olive</p> <p>12 Dark Green</p> <p>13 Nickel</p> <p>14 Dark Gray</p> <p>15 Black</p>	<p>Glide Options</p> <p>PG Plastic Glide Recommended for easier movement on carpet. +00</p> <p>FG Felt Glide Recommended for easier movement on hard floors. +00</p> <p>RG Rubber Glides Recommended for static positioning. +00</p> <p>L1 Round Legs Legs increase seating height by 2". All standard Stylex powder paints and Polished Aluminum are available leg finish choices. +112</p>	<p>G Ganging +00</p> <p>C1X In-seat power port with 10' power cord +337</p> <p>C2X In-seat power port with 20' power cord +393</p> <p>W1X 12' BX whip (for hardwiring) +674</p> <p>W2X 24' BX whip (for hardwiring) +786</p>	<p>Yoom Rolled fabrics must be cut up the roll.</p> <p>Yoom Rolled is designed to have a casual look and feel. It is meant to show wrinkling with most fabrics.</p> <p>Refer to Stylex swatch cards and separately published in-graded fabric program to determine grades.</p> <p>See General Information section in the main price list for CAL 133 Information.</p>



Decorative Stitch on all edges (available on woven textiles only)

SSD1 Blanket stitch over single seam +10% of COM List

SSD2 Zig Zag stitch over single seam +10% of COM List

SSD3 Bowtie stitch over single seam +10% of COM List

Thread color must be specified.
Reference Stylex/Stitching on Stylexseating.com for thread colors and stitch images.

Yoom Rolled

Chaise Right and Left

Modular Lounge Systems

C.O.M.

C.O.M.
Fabric Upholstery
Grades

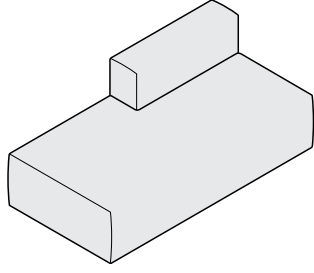
Series	Style	Type	Description	Ydg.	C.O.M.	A	B	C	D	E	F	G	H	I	J	K	L	M	
	YM	8	1631	Chaise Right Rolled Front Depth 34" Height 26" Seat Height 15" Width 68"	7.2	2,970	3,371	3,588	3,798	4,017	4,234	4,472	4,711	4,992	5,357	5,792	6,227	6,656	7,091
	YM	8	1731	Chaise Left Rolled Front Depth 34" Height 26" Seat Height 15" Width 68"	7.2	2,970	3,371	3,588	3,798	4,017	4,234	4,472	4,711	4,992	5,357	5,792	6,227	6,656	7,091

To Order follow steps 1-7

1 Series/Style	2 Type	3 Seam Option	4 Decorative Stitch Colors	5 Glides/Casters/Legs	6 Options	7 Fabrics
<p>YMB Yoom Rolled Front</p>	<p>1631 Chaise Right</p> <p>1731 Chaise Left</p>	<p>Seam Option</p> <p>SS Single seam on all edges +00</p> <p>SP Pinch seam on top edges +00</p> <p>SW Standard welt cord on all edges +10% of COM List</p> <p>Decorative Stitch on all edges (available on woven textiles only)</p> <p>SSD1 Blanket stitch over single seam +10% of COM List</p> <p>SSD2 Zig Zag stitch over single seam +10% of COM List</p> <p>SSD3 Bowtie stitch over single seam +10% of COM List</p> <p>Thread color must be specified. Reference Stylex/Stitching on Stylexseating.com for thread colors and stitch images.</p>	<p>Decorative Stitch Color</p> <p>01 White</p> <p>02 Natural</p> <p>03 Lemon</p> <p>04 Pebble Beige</p> <p>05 Dk Mahogany</p> <p>06 Orange</p> <p>07 Red</p> <p>08 Purple</p> <p>09 Pro Blue</p> <p>10 Navy</p> <p>11 Olive</p> <p>12 Dark Green</p> <p>13 Nickel</p> <p>14 Dark Gray</p> <p>15 Black</p>	<p>Glide Options</p> <p>PG Plastic Glide +00 Recommended for easier movement on carpet.</p> <p>FG Felt Glide +00 Recommended for easier movement on hard floors.</p> <p>RG Rubber Glides +00 Recommended for static positioning.</p> <p>L1 Round Legs +112 Legs increase seating height by 2". All standard Stylex powder paints and Polished Aluminum are available leg finish choices.</p>	<p>G Ganging +00</p> <p>C1X In-seat power port with 10' power cord +337</p> <p>C2X In-seat power port with 20' power cord +393</p> <p>W1X 12' BX whip (for hardwiring) +674</p> <p>W2X 24' BX whip (for hardwiring) +786</p> <p>See Page 6 for complete information on specifying power ports.</p>	<p>Yoom Rolled fabrics must be cut up the roll.</p> <p>Yoom Rolled is designed to have a casual look and feel. It is meant to show wrinkling with most fabrics.</p> <p>Refer to Stylex swatch cards and separately published in-graded fabric program to determine grades.</p> <p>See General Information section in the main price list for CAL 133 Information.</p>

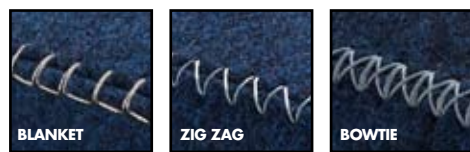

Yoom Rolled

Corner and Narrow Chair

Modular Lounge Systems

C.O.M.

C.O.M.
Fabric Upholstery
Grades

Series	Style	Type	Description	Ydg.	C.O.M.	A	B	C	D	E	F	G	H	I	J	K	L	M
YM	9	13	Corner Chair Boxed Front Single Narrow Seat Depth 25" Height 15" Width 25"	1.7	918	1,011	1,061	1,109	1,160	1,210	1,265	1,320	1,385	1,469	1,569	1,670	1,769	1,869
	8	37	Rolled Front Corner Back Depth 34" Height 26" Width 34"	3.3	972	1,163	1,267	1,367	1,471	1,575	1,688	1,803	1,936	2,110	2,318	2,525	2,730	2,938
YM	8	1333	Narrow Chair Rolled Front Depth 25" Height 26" Seat Height 15" Width 25"	4.0	1,512	1,733	1,854	1,971	2,091	2,212	2,344	2,476	2,632	2,834	3,075	3,316	3,553	3,794

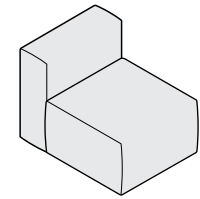
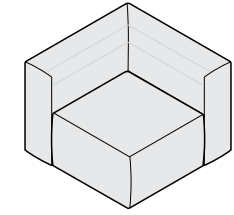

To Order follow steps 1-7

1 Series/Style 2 Type 3 Seam Option 4 Decorative Stitch Colors 5 Glides/Casters/Legs 6 Options 7 Fabrics

1 Series/Style

YMB Yoom Rolled Front

YMB Corner Chair YM913/YM837
Note: Corner chair is ordered as two separate lines.

1333 Narrow Chair YM81333

2 Type

3 Seam Option

SS Single seam on all edges +00

SP Pinch seam on top edges +00

Single seam on side edges

SW Standard welt cord on all edges +10% of COM List

4 Decorative Stitch Colors

SSD1 Blanket stitch over single seam +10% of COM List

SSD2 Zig Zag stitch over single seam +10% of COM List

SSD3 Bowtie stitch over single seam +10% of COM List

Decorative Stitch on all edges (available on woven textiles only)

Thread color must be specified.
Reference Stylex/Stitching on Stylexseating.com for thread colors and stitch images.

5 Glides/Casters/Legs

Decorative Stitch Color

01 White

02 Natural

03 Lemon

04 Pebble Beige

05 Dk Mahogany

06 Orange

07 Red

08 Purple

09 Pro Blue

10 Navy

11 Olive

12 Dark Green

13 Nickel

14 Dark Gray

15 Black

6 Options

PG Plastic Glide +00
Recommended for easier movement on carpet.

FG Felt Glide +00
Recommended for easier movement on hard floors.

RG Rubber Glides +00
Recommended for static positioning.

Caster Options

CH Hard Wheel Caster +65
Recommended for full mobility in collaborative settings.

CS Soft Wheel Caster +65
Recommended for full mobility in collaborative settings.

L1 Round Legs +112
Legs increase seating height by 2".
All standard Stylex powder paints and Polished Aluminum are available leg finish choices.

7 Fabrics

G Ganging +00

C1X In-seat power port with 10' power cord +337

C2X In-seat power port with 20' power cord +393

W1X 12' BX whip (for hardwiring) +674

W2X 24' BX whip (for hardwiring) +786

See Page 6 for complete information on specifying power ports.

Yoom Rolled fabrics must be cut up the roll.

Yoom Rolled is designed to have a casual look and feel. It is meant to show wrinkling with most fabrics.

Refer to Stylex swatch cards and separately published in-graded fabric program to determine grades.

See General Information section in the main price list for CAL 133 Information.

Yoom Rolled

Single Chair with Right or Left Arm

Modular Lounge Systems

C.O.M.

C.O.M.
Fabric Upholstery
Grades

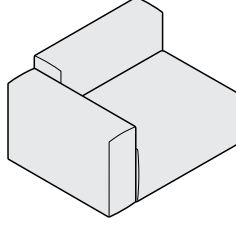
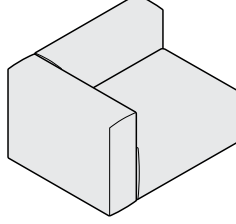
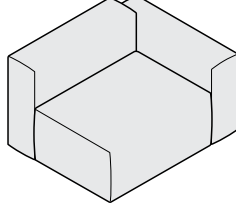
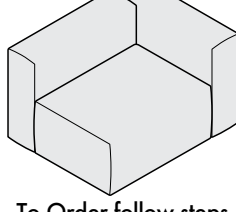
Series	Style	Type	Description	Ydg.	C.O.M.	A	B	C	D	E	F	G	H	I	J	K	L	M	
	YM	8	113151R	Single Chair with Right Low Arm Rolled Front Depth 34" Height 26" Seat Height 15" Arm Height 22" Width 43"	6.2	2,322	2,667	2,854	3,036	3,223	3,411	3,616	3,822	4,064	4,378	4,753	5,128	5,497	5,872
	YM	8	113131R	Single Chair with Right High Arm Rolled Front Depth 34" Height 26" Seat Height 15" Arm Height 26" Width 43"	6.4	2,430	2,787	2,981	3,169	3,363	3,558	3,770	3,983	4,234	4,560	4,949	5,336	5,719	6,107
	YM	8	113151L	Single Chair with Left Low Arm Rolled Front Depth 34" Height 26" Seat Height 15" Arm Height 22" Width 43"	6.2	2,322	2,667	2,854	3,036	3,223	3,411	3,616	3,822	4,064	4,378	4,753	5,128	5,497	5,872
	YM	8	113131L	Single Chair with Left High Arm Rolled Front Depth 34" Height 26" Seat Height 15" Arm Height 26" Width 43"	6.4	2,430	2,787	2,981	3,169	3,363	3,558	3,770	3,983	4,234	4,560	4,949	5,336	5,719	6,107

To Order follow steps 1-7

1 Series/Style	2 Type	3 Seam Option	4 Decorative Stitch Colors	5 Glides/Casters/Legs	6 Options	7 Fabrics
<p>YMB Yoom Rolled Front</p> <p>113151R Single Chair with Right Low Arm</p> <p>113131R Single Chair with Right High Arm</p> <p>113151L Single Chair with Left Low Arm</p> <p>113131L Single Chair with Left High Arm</p>		<p>Seam Option</p> <p>SS Single seam on all edges +00</p> <p>SP Pinch seam on top edges Single seam on side edges +00</p> <p>SW Standard welt cord on all edges +10% of COM List</p> <p>Decorative Stitch on all edges</p> <p>SSD1 Blanket stitch over single seam +10% of COM List</p> <p>SSD2 Zig Zag stitch over single seam +10% of COM List</p> <p>SSD3 Bowtie stitch over single seam +10% of COM List</p> <p>Thread color must be specified. Reference Stylex/Stitching on Stylexseating.com for thread colors and stitch images.</p>	<p>Decorative Stitch Color</p> <p>01 White</p> <p>02 Natural</p> <p>03 Lemon</p> <p>04 Pebble Beige</p> <p>05 Dk Mahogany</p> <p>06 Orange</p> <p>07 Red</p> <p>08 Purple</p> <p>09 Pro Blue</p> <p>10 Navy</p> <p>11 Olive</p> <p>12 Dark Green</p> <p>13 Nickel</p> <p>14 Dark Gray</p> <p>15 Black</p>	<p>Glide Options</p> <p>PG Plastic Glide +00 Recommended for easier movement on carpet.</p> <p>FG Felt Glide +00 Recommended for easier movement on hard floors.</p> <p>RG Rubber Glides +00 Recommended for static positioning.</p> <p>Caster Options</p> <p>CH Hard Wheel Caster +65 Recommended for full mobility in collaborative settings.</p> <p>CS Soft Wheel Caster +65 Recommended for full mobility in collaborative settings.</p> <p>Round Legs +112 Legs increase seating height by 2". All standard Stylex powder paints and Polished Aluminum are available leg finish choices.</p>	<p>Ganging +00</p> <p>C1X In-seat power port with 10' power cord +337</p> <p>C2X In-seat power port with 20' power cord +393</p> <p>W1X 12' BX whip (for hardwiring) +674</p> <p>W2X 24' BX whip (for hardwiring) +786</p> <p>See Page 6 for complete information on specifying power ports.</p>	<p>Yoom Rolled fabrics must be cut up the roll.</p> <p>Yoom Rolled is designed to have a casual look and feel. It is meant to show wrinkling with most fabrics.</p> <p>Refer to Stylex swatch cards and separately published in-graded fabric program to determine grades.</p> <p>See General Information section in the main price list for CAL 133 Information.</p>



Yoom Rolled

Single Full Chair with Right or Left Arm

Modular Lounge Systems

C.O.M.

C.O.M.
Fabric Upholstery
Grades

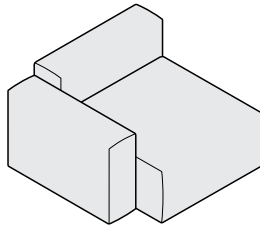
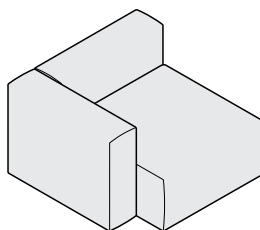
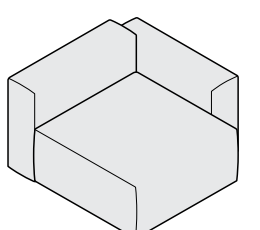
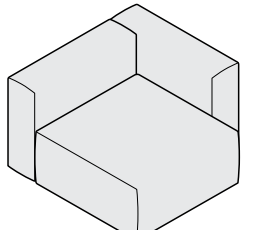
Series	Style	Type	Description	Ydg.	C.O.M.	A	B	C	D	E	F	G	H	I	J	K	L	M	
	YM	8	123151R	Single Full Chair with Right Low Arm	7.0	2,538	2,932	3,146	3,353	3,568	3,782	4,018	4,252	4,528	4,888	5,317	5,746	6,167	6,596
				Rolled Front															
				Depth 43"															
				Height 26"															
				Seat Height 15"															
Arm Height 22"																			
Width 43"																			
	YM	8	123131R	Single Full Chair with Right High Arm	7.3	2,646	3,052	3,273	3,487	3,708	3,929	4,171	4,414	4,699	5,070	5,511	5,953	6,388	6,830
				Rolled Front															
				Depth 43"															
				Height 26"															
				Seat Height 15"															
Arm Height 26"																			
Width 43"																			
	YM	8	123151L	Single Full Chair with Left Low Arm	7.0	2,538	2,932	3,146	3,353	3,568	3,782	4,018	4,252	4,528	4,888	5,317	5,746	6,167	6,596
				Rolled Front															
				Depth 43"															
				Height 26"															
				Seat Height 15"															
Arm Height 22"																			
Width 43"																			
	YM	8	123131L	Single Full Chair with Left High Arm	7.3	2,646	3,052	3,273	3,487	3,708	3,929	4,171	4,414	4,699	5,070	5,511	5,953	6,388	6,830
				Rolled Front															
				Depth 43"															
				Height 26"															
				Seat Height 15"															
Arm Height 26"																			
Width 43"																			

To Order follow steps 1-7

1 Series/Style 2 Type 3 Seam Option 4 Decorative Stitch Colors 5 Glides/Casters/Legs 6 Options 7 Fabrics

1 Series/Style

YM8 Yoom Rolled Front

2 Type

123151R Single Full Chair with Right Low Arm

123131R Single Full Chair with Right High Arm

123151L Single Full Chair with Left Low Arm

123131L Single Full Chair with Left High Arm

3 Seam Option

SS Single seam on all edges +00

SP Pinch seam on top edges
Single seam on side edges +00

SW Standard welt cord on all edges +10% of COM List

Decorative Stitch on all edges

SSD1 Blanket stitch over single seam +10% of COM List

SSD2 Zig Zag stitch over single seam +10% of COM List

SSD3 Bowtie stitch over single seam +10% of COM List

Thread color must be specified.
Reference Stylex/Stitching on Stylexseating.com for thread colors and stitch images.

4 Decorative Stitch Colors

01 White

02 Natural

03 Lemon

04 Pebble Beige

05 Dk Mahogany

06 Orange

07 Red

08 Purple

09 Pro Blue

10 Navy

11 Olive

12 Dark Green

13 Nickel

14 Dark Gray

15 Black

5 Glides/Casters/Legs

Glide Options

PG Plastic Glide +00
Recommended for easier movement on carpet.

FG Felt Glide +00
Recommended for easier movement on hard floors.

RG Rubber Glides +00
Recommended for static positioning.

Caster Options

CH Hard Wheel Caster +65
Recommended for full mobility in collaborative settings.

CS Soft Wheel Caster +65
Recommended for full mobility in collaborative settings.

Round Legs +112
Legs increase seating height by 2".
All standard Stylex powder paints and Polished Aluminum are available leg finish choices.

6 Options

G Ganging +00

C1X In-seat power port with 10' power cord +337

C2X In-seat power port with 20' power cord +393

W1X 12' BX whip (for hardwiring) +674

W2X 24' BX whip (for hardwiring) +786

See Page 6 for complete information on specifying power ports.

7 Fabrics

+00 Yoom Rolled fabrics must be cut up the roll.

Yoom Rolled is designed to have a casual look and feel. It is meant to show wrinkling with most fabrics.

Refer to Stylex swatch cards and separately published in-graded fabric program to determine grades.

See General Information section in the main price list for CAL 133 Information.